

• 10 junio 2007

STUW

~~A 21 31~~  
P 231

GVA

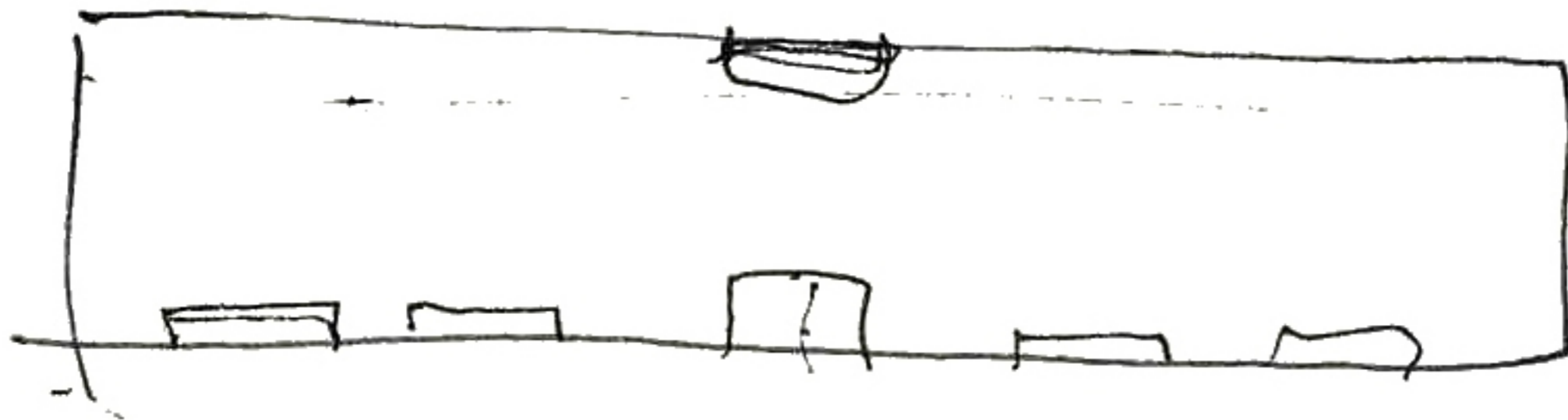
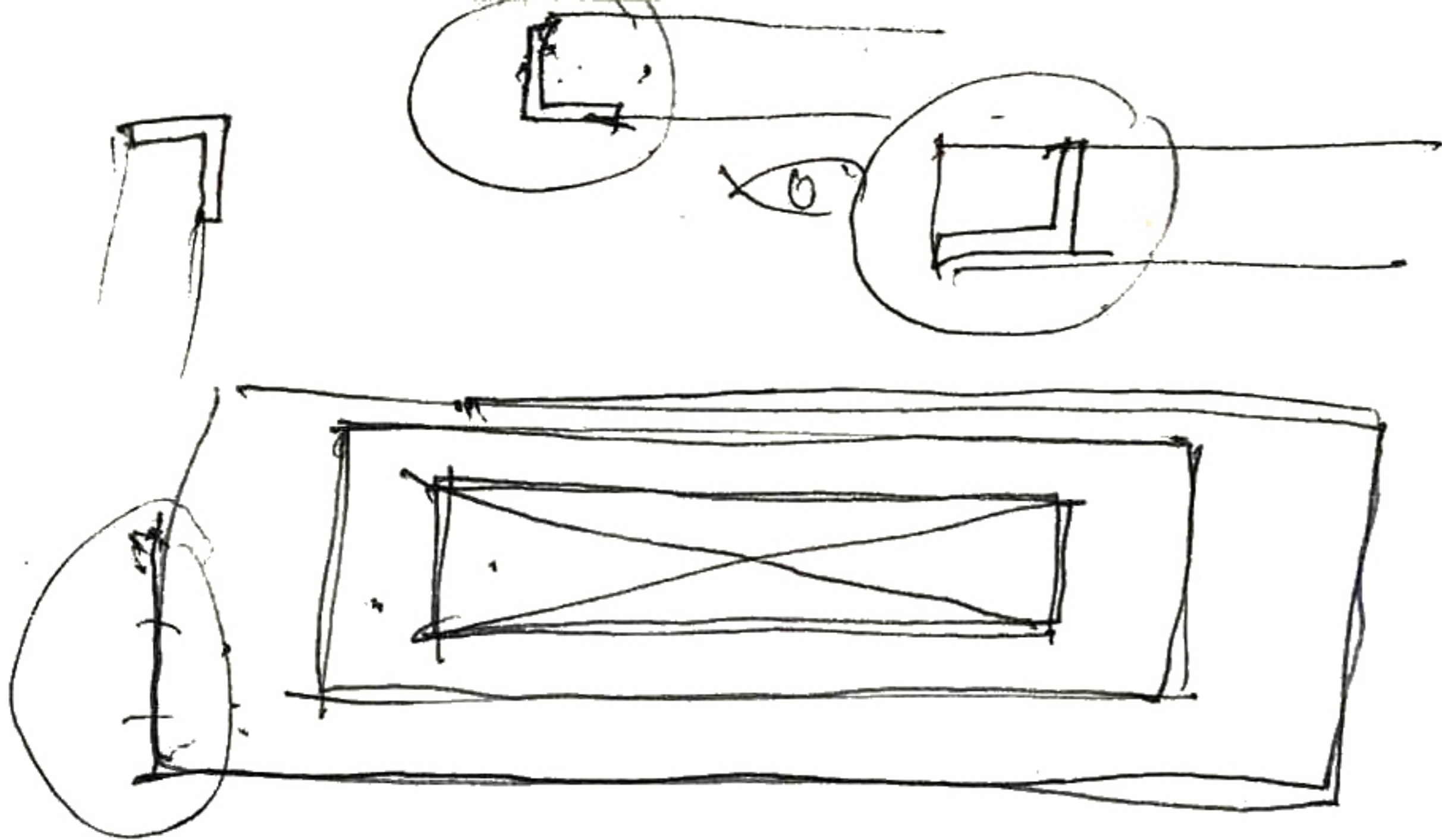

$$\begin{array}{r}
 6588 \\
 2350 \\
 \hline
 4238
 \end{array}$$

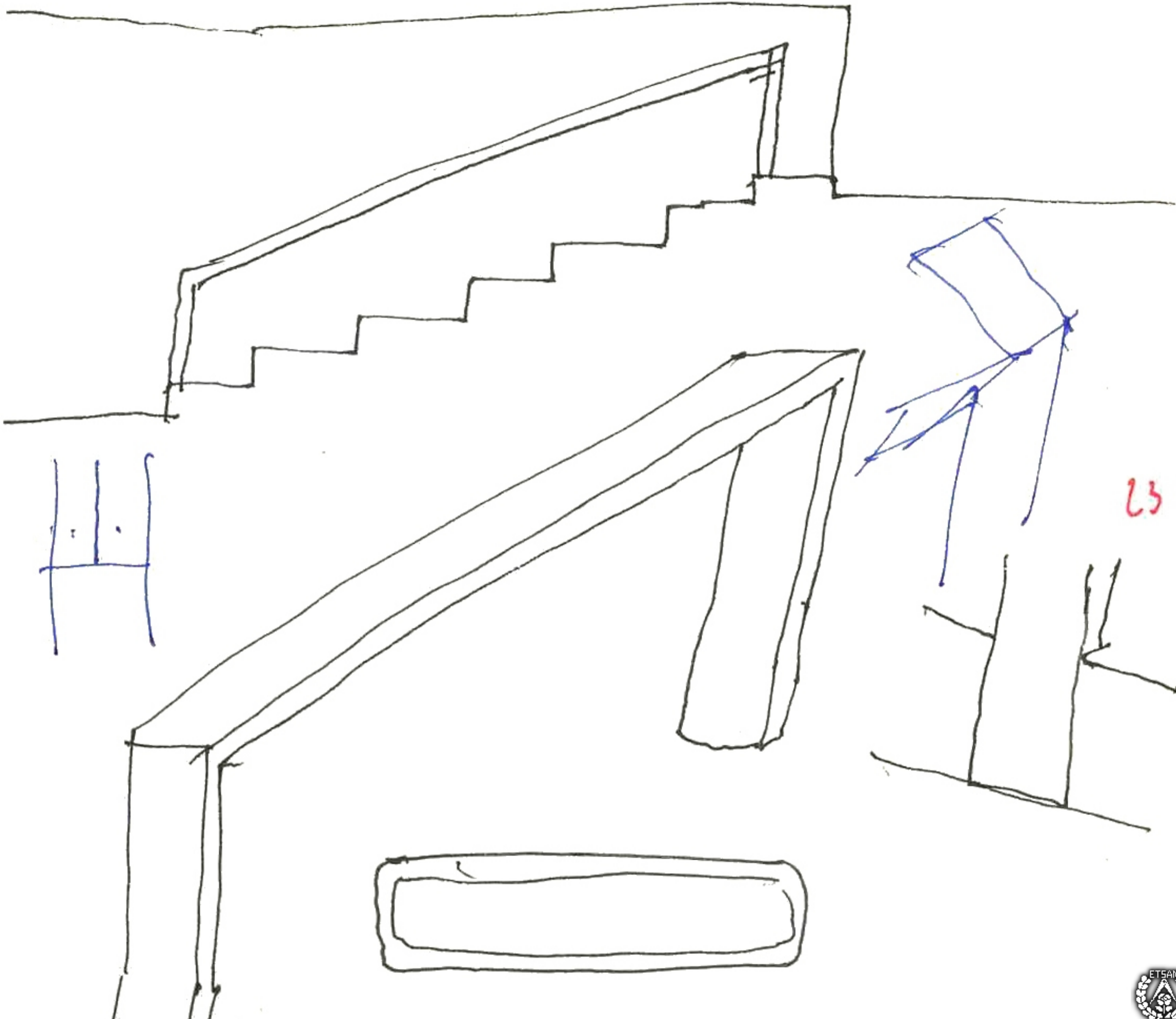

23

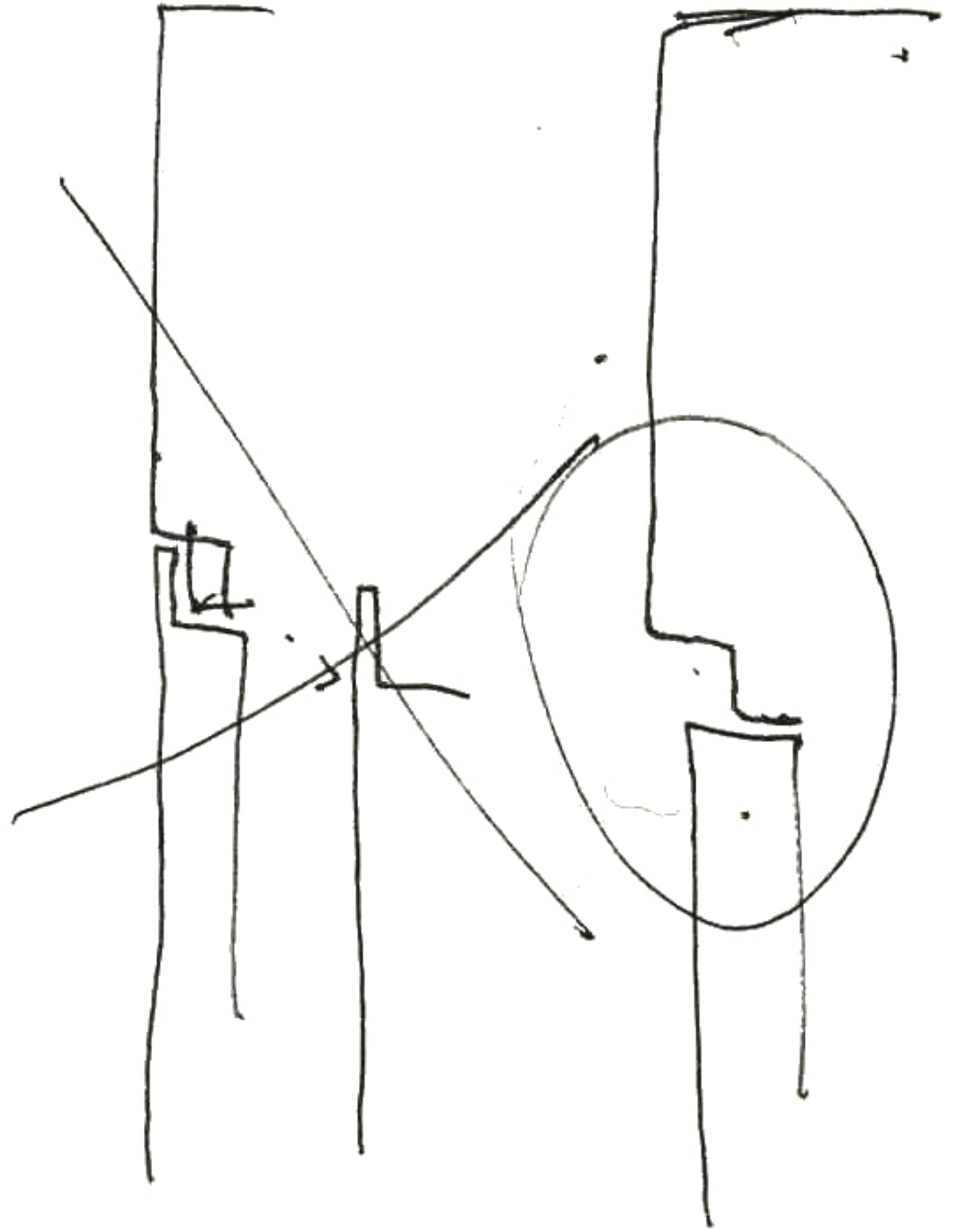
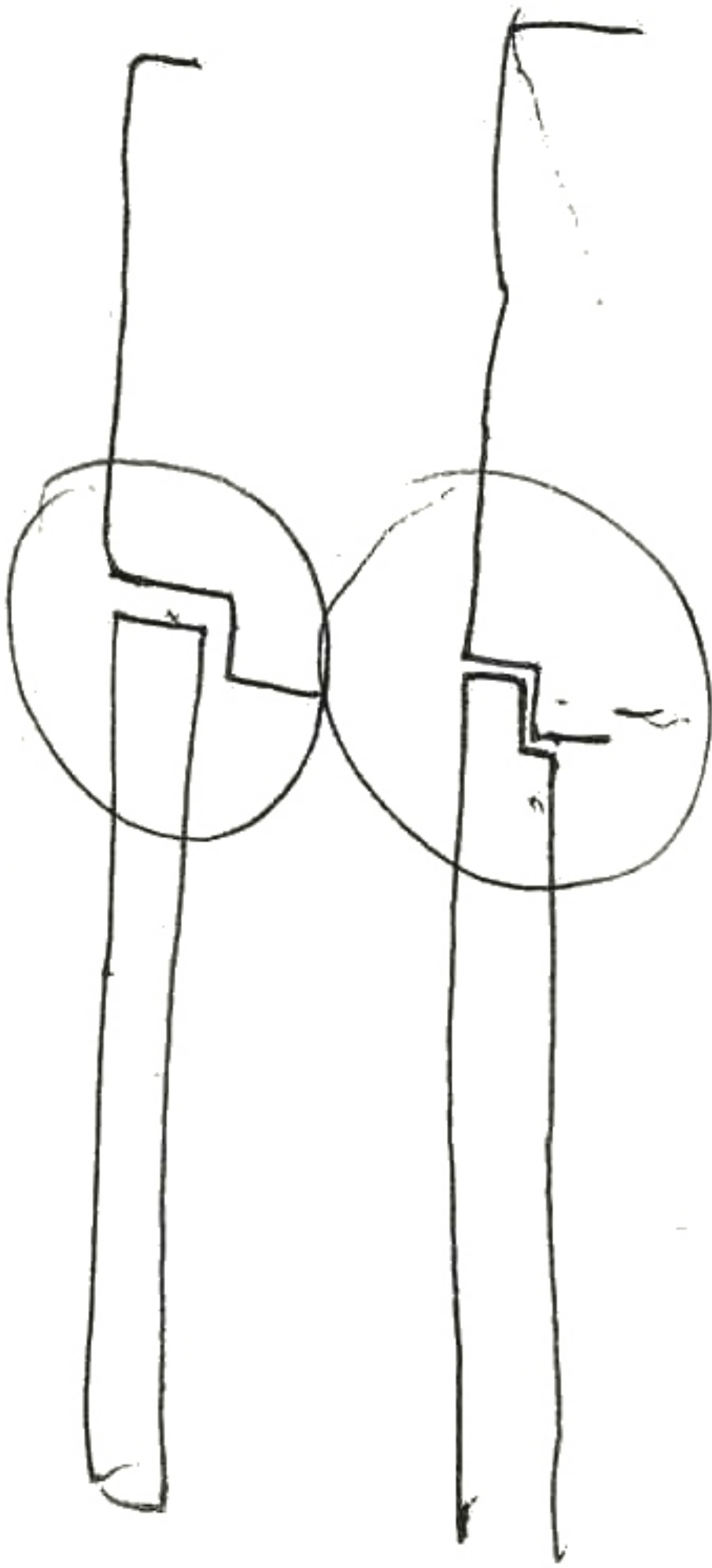
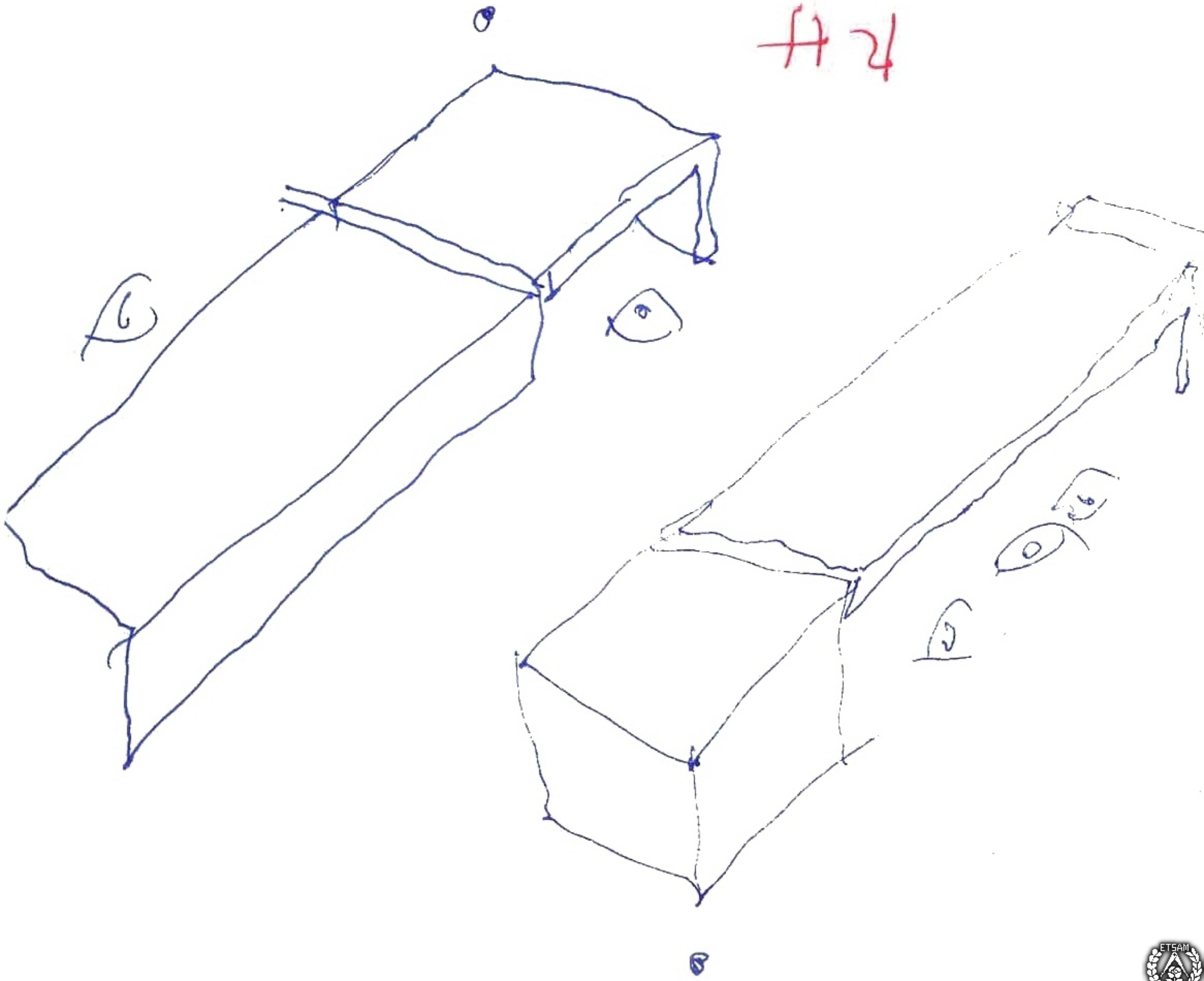
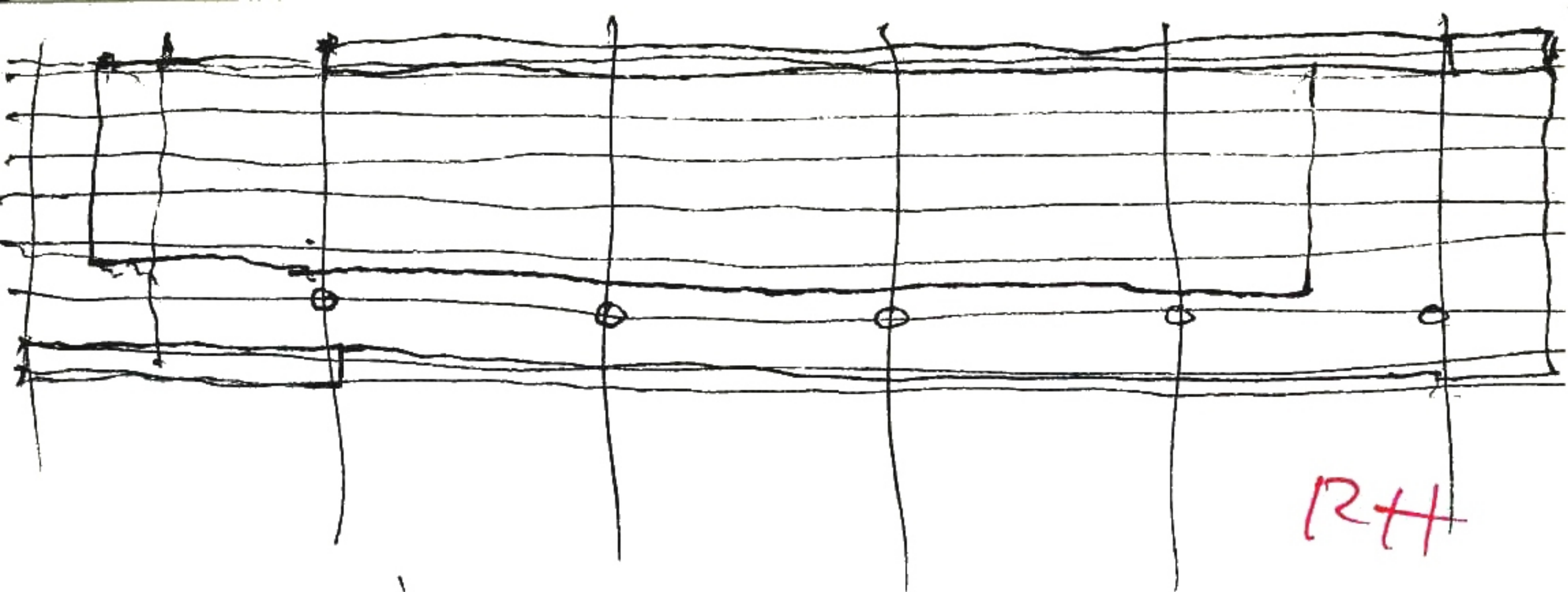
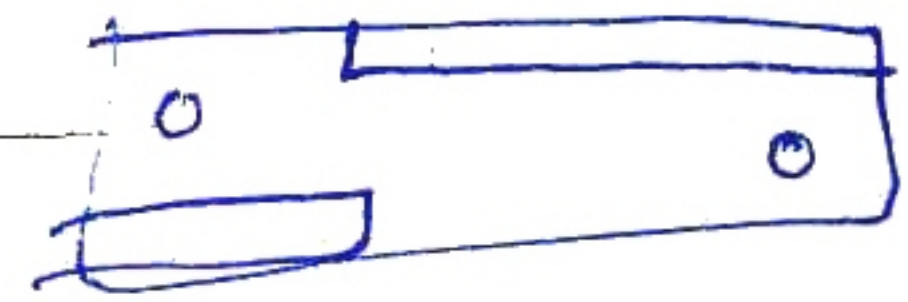
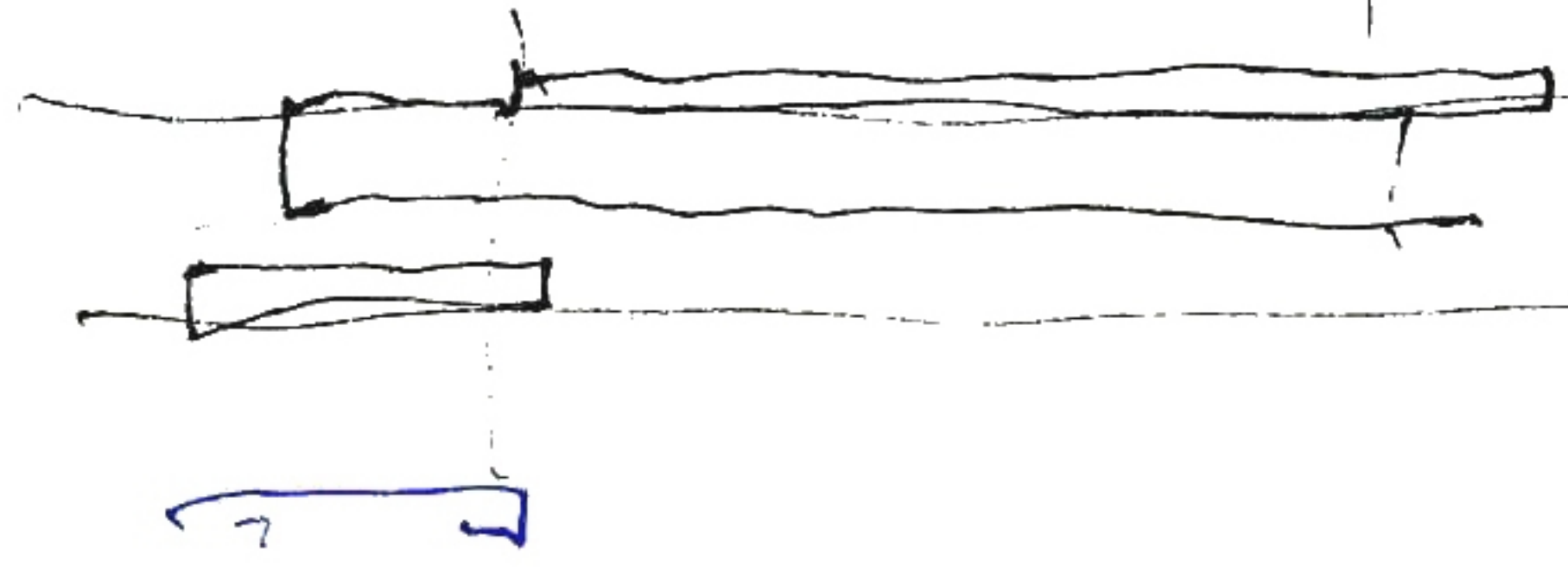

Fig 24





RH



41

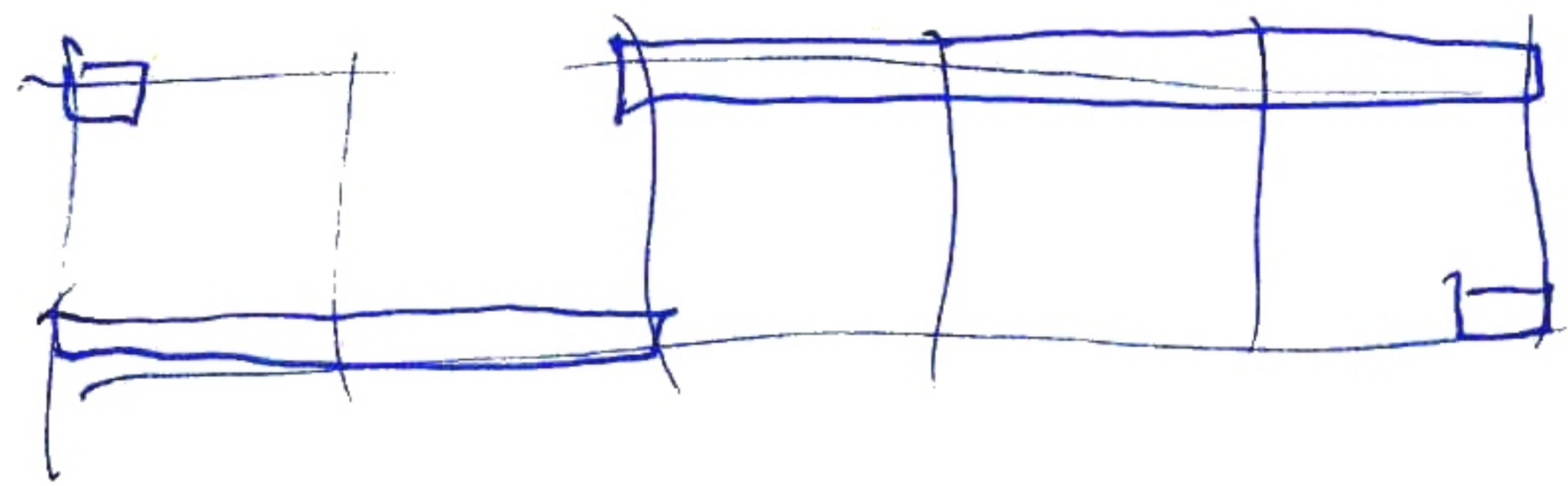

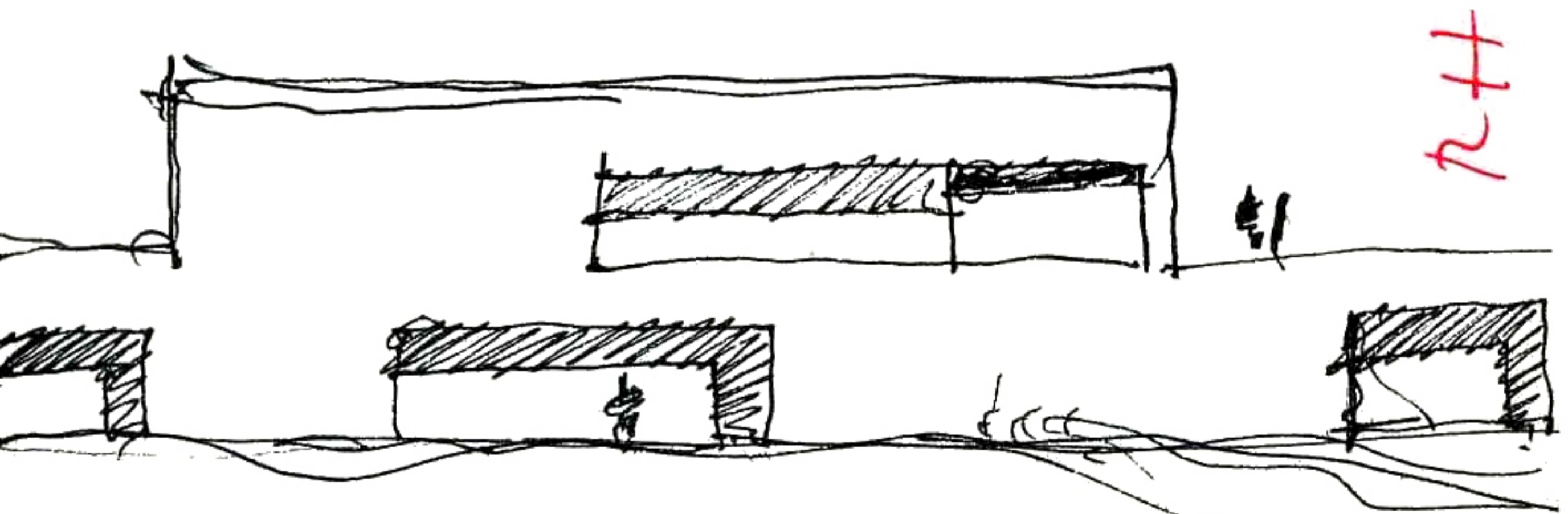
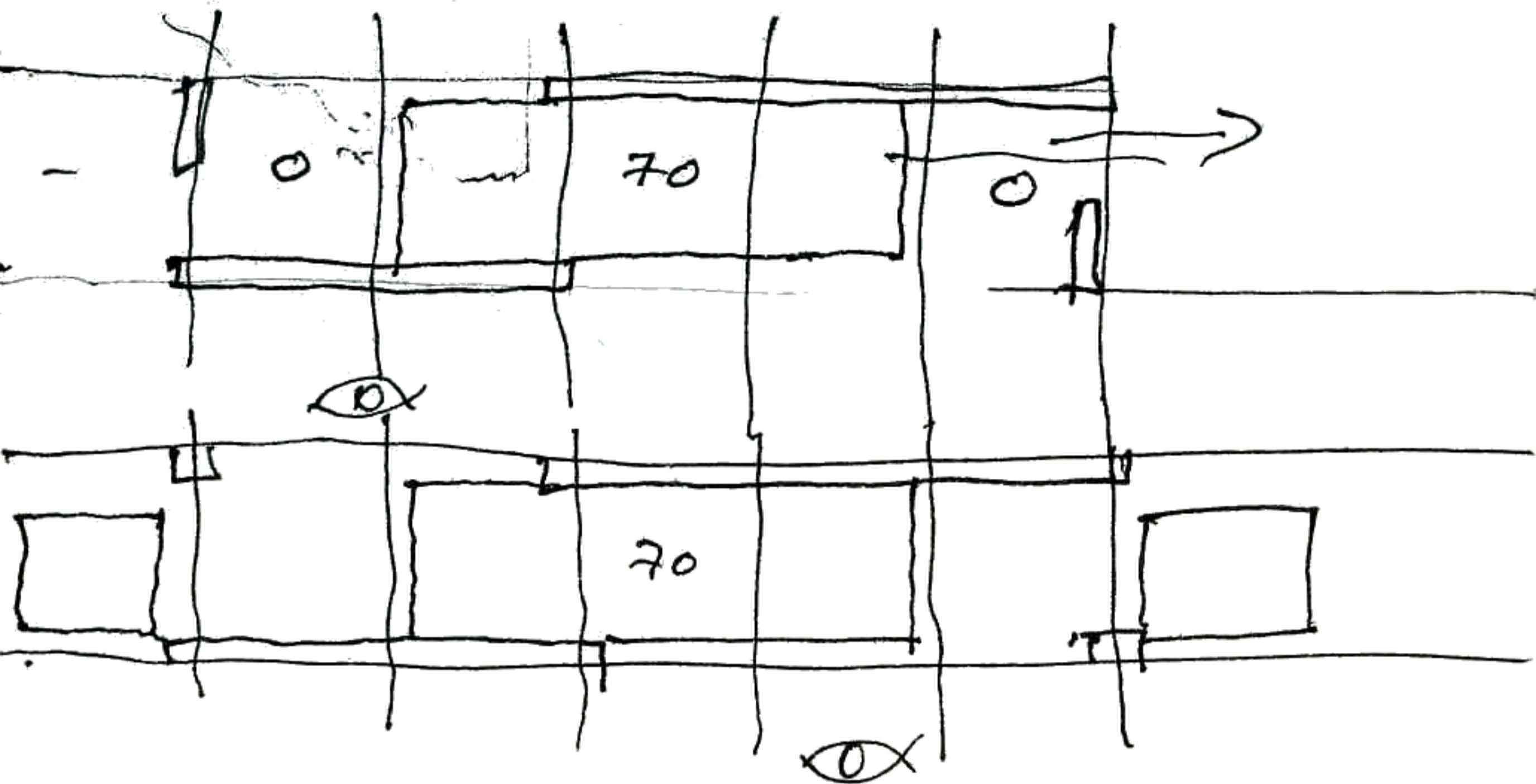

en la ETSAM  
antes del PFC

July 2. 2007.

*[Handwritten signature]*



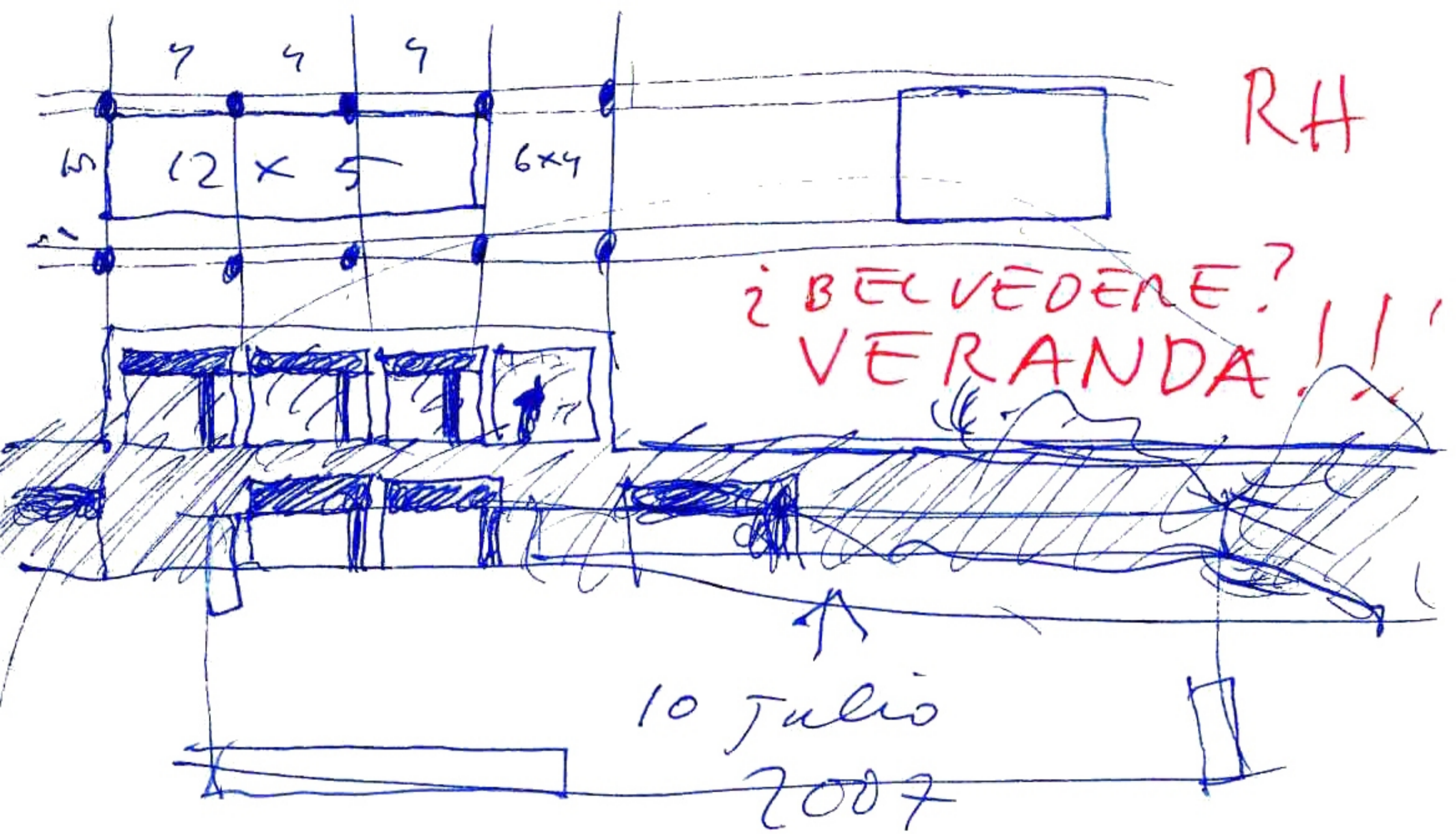

RH

¿BELVEDERE?  
VERANDA!!!

10 Julio  
2007

RUFO HOUSE

in TOLEDO



mercoledì  
luglio 11 2007  
al relais MONACO  
en TREVI

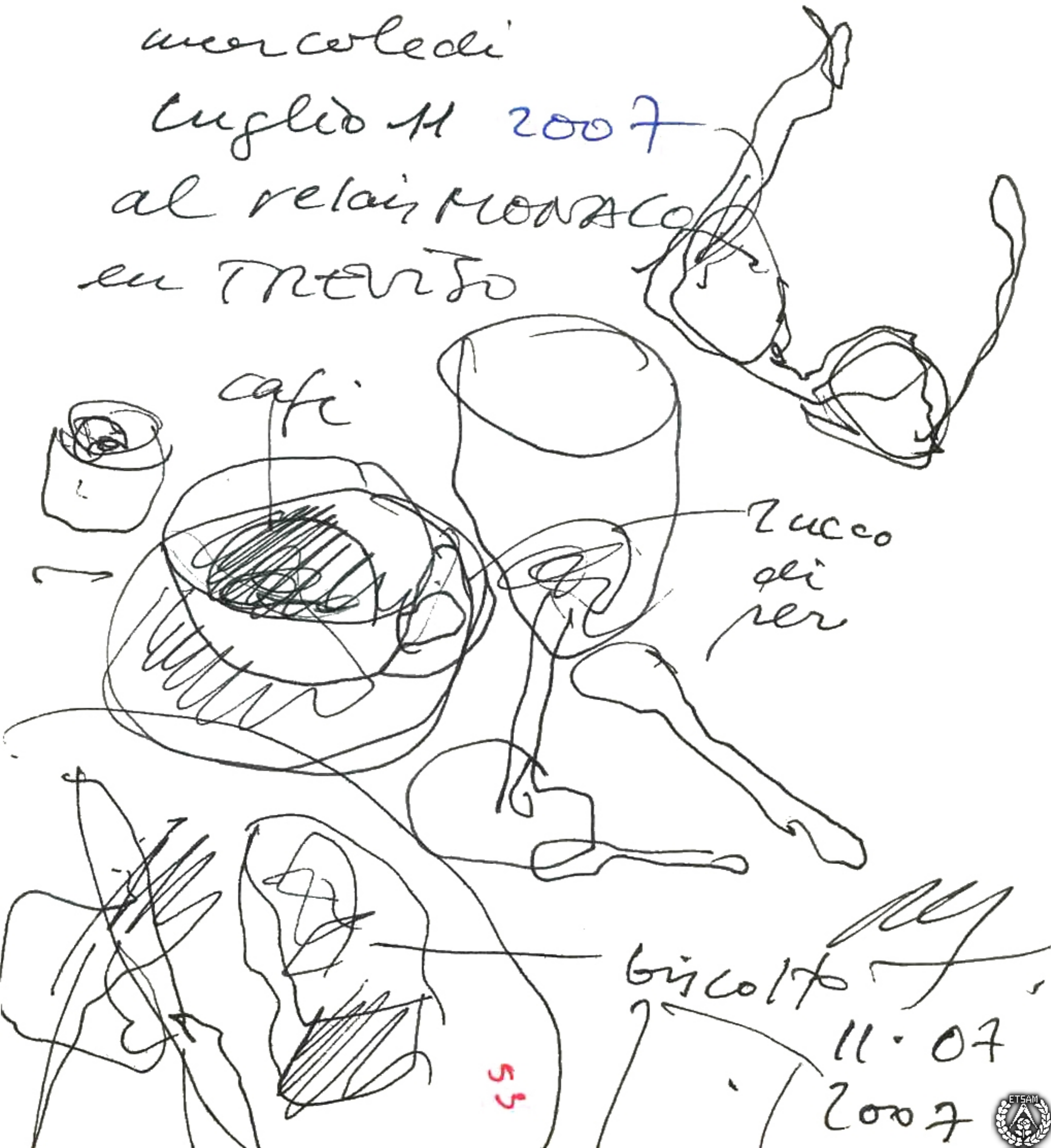

café

Zucchero  
di  
per

biscotti

55

11.07  
2007



Acqua di  
Beechton

11  
luglio  
2007

066'

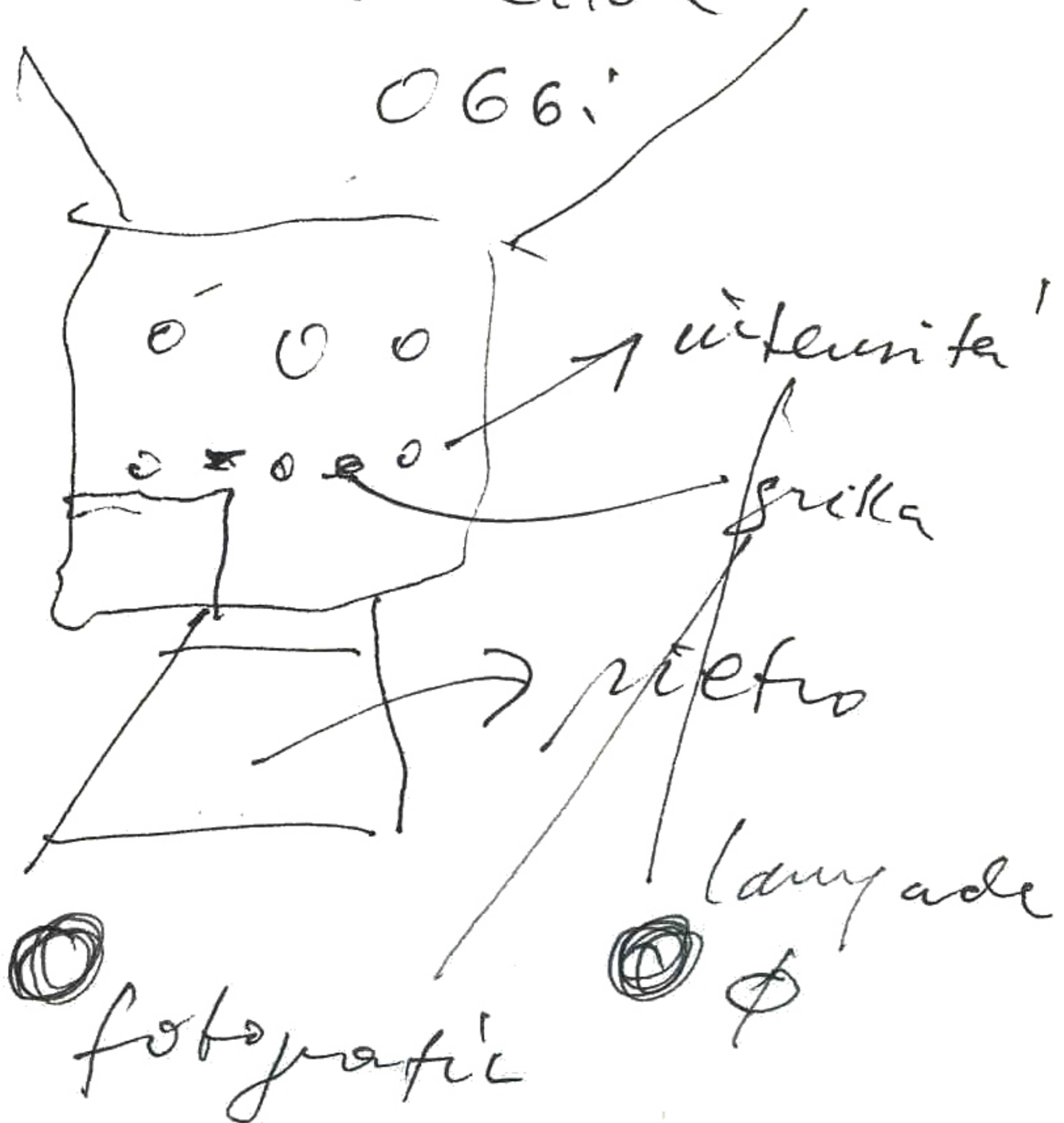

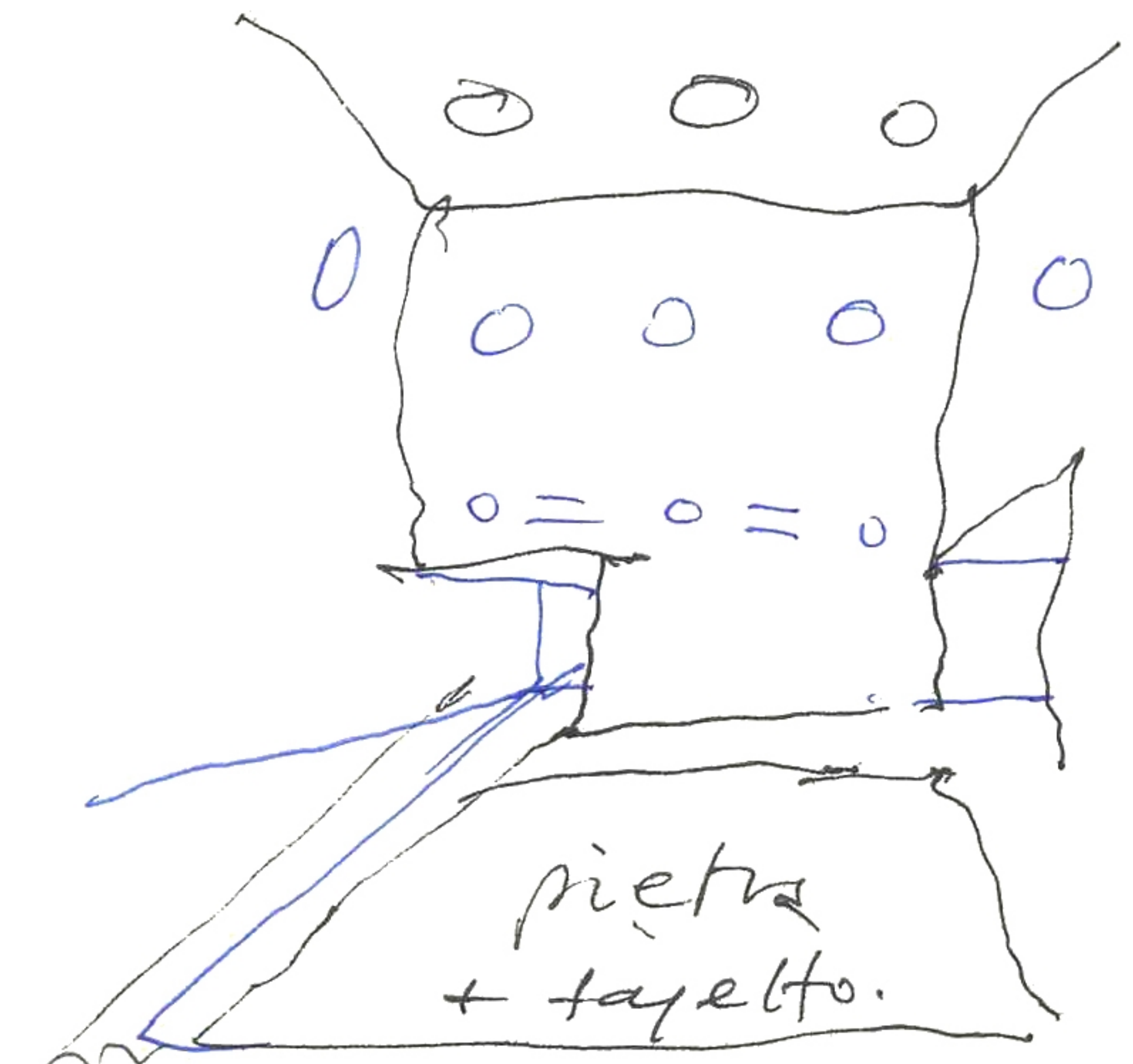

pietra  
+ tavoletto.

various

- durabilidad
- adecuación
- Lógica
- tavolo + acrífico
- sensibilidad

55

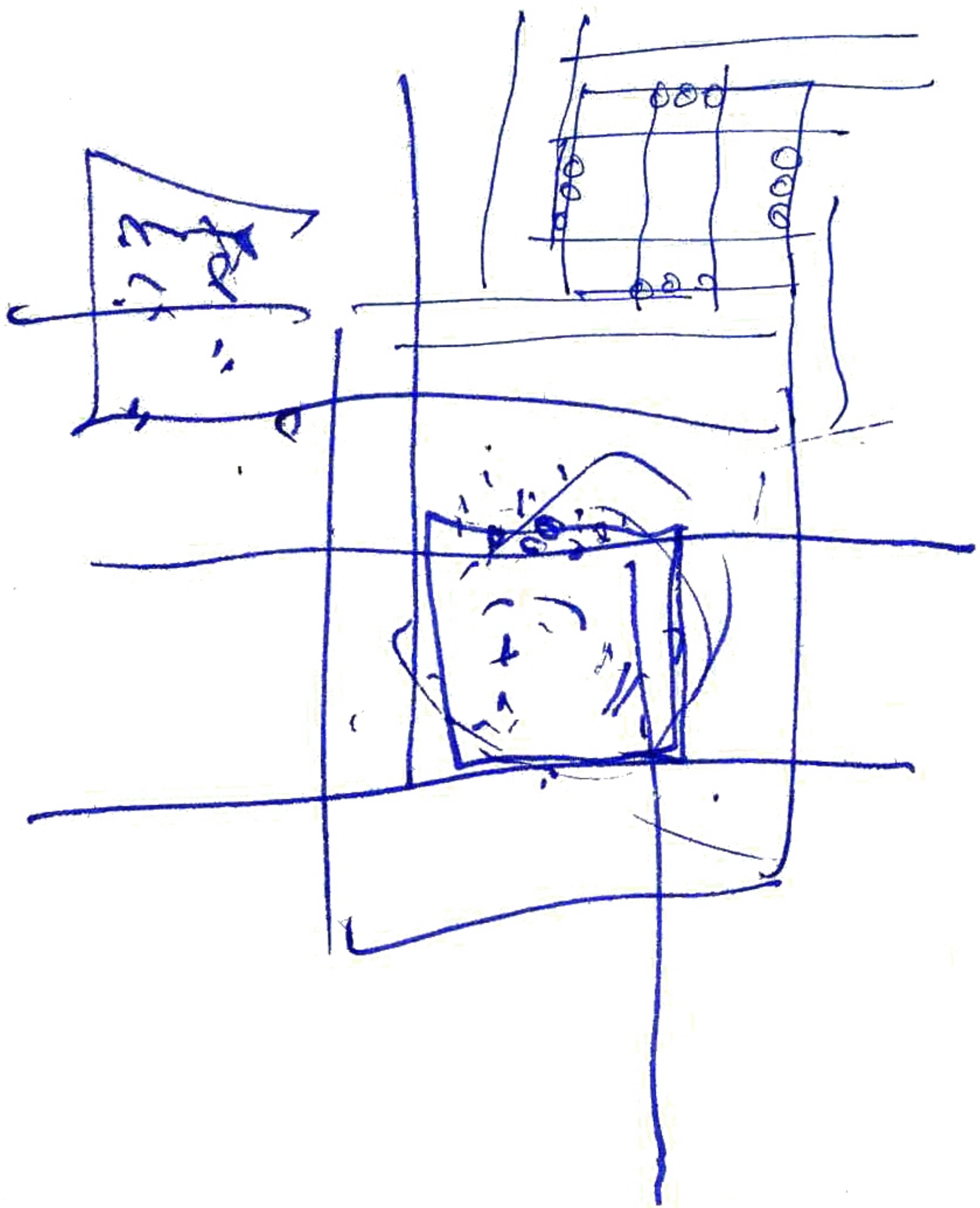

57



3

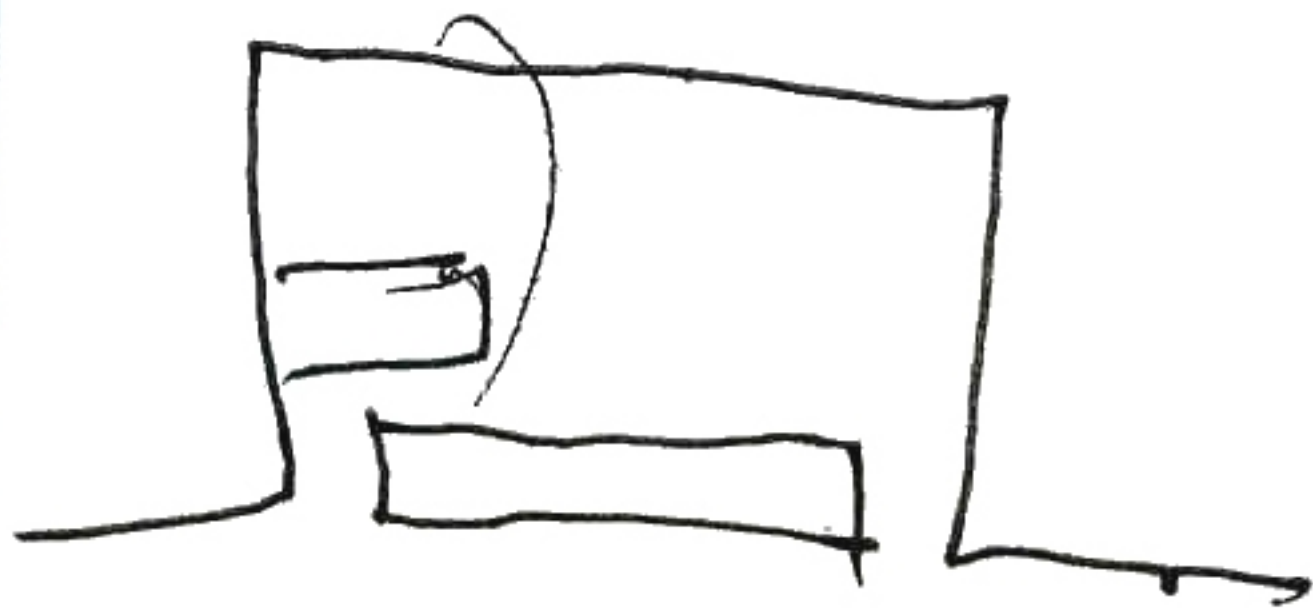
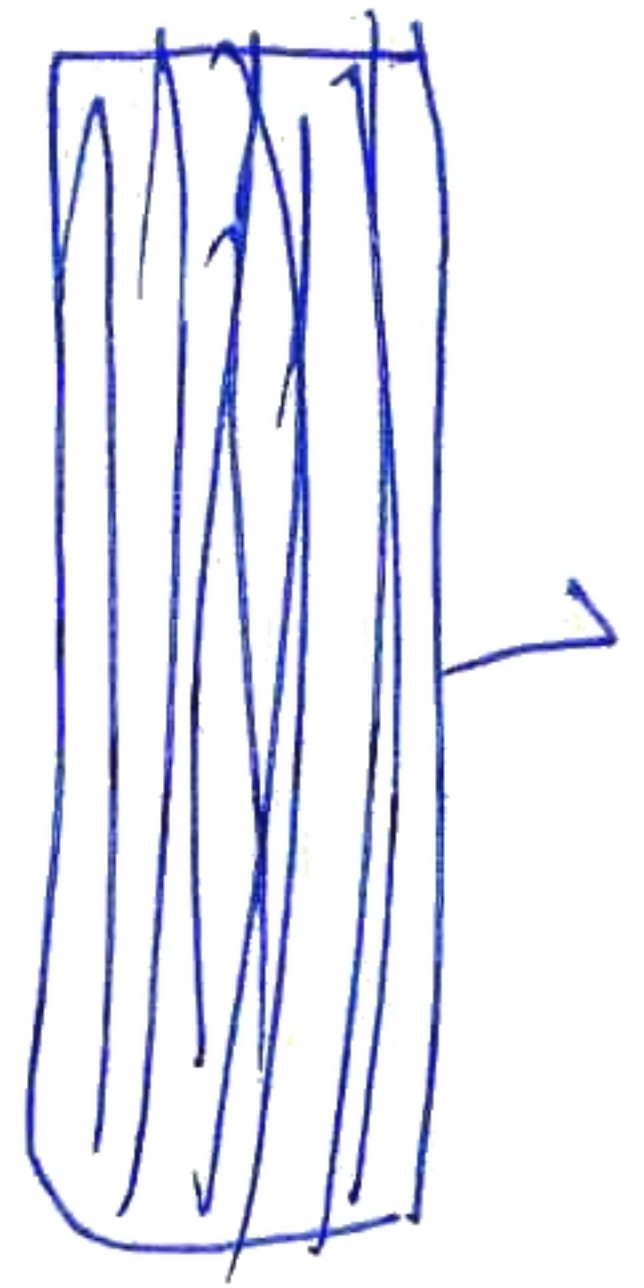
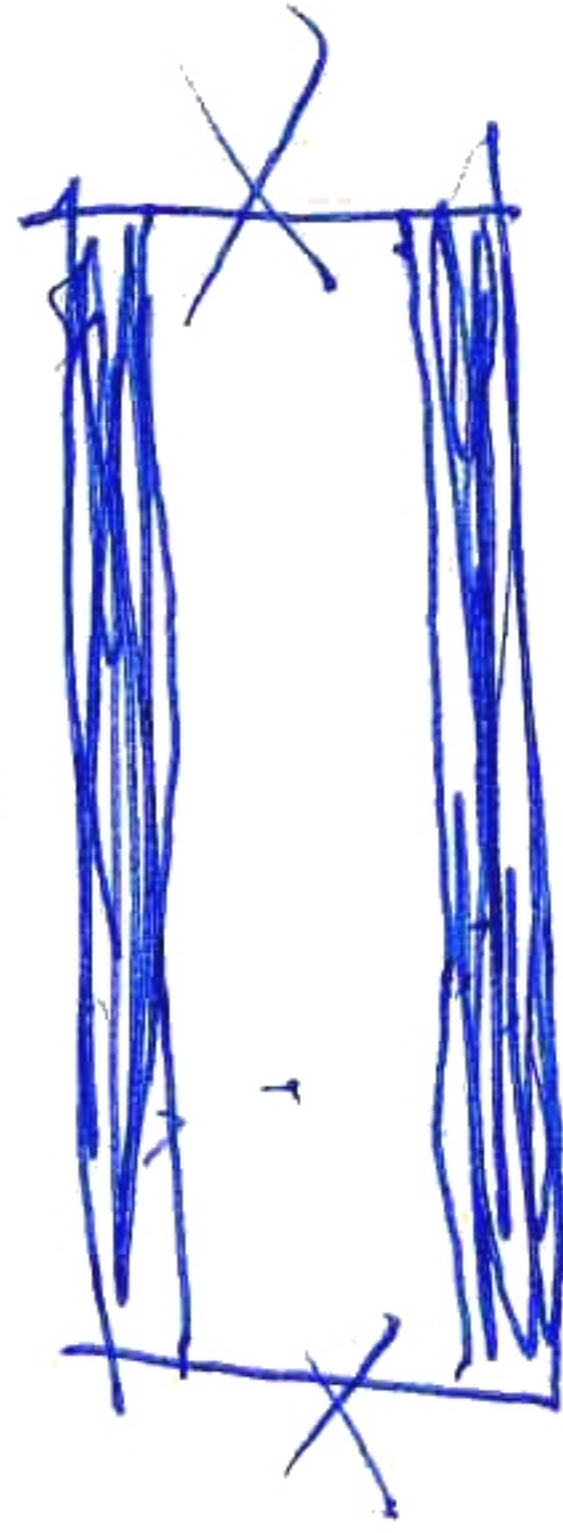

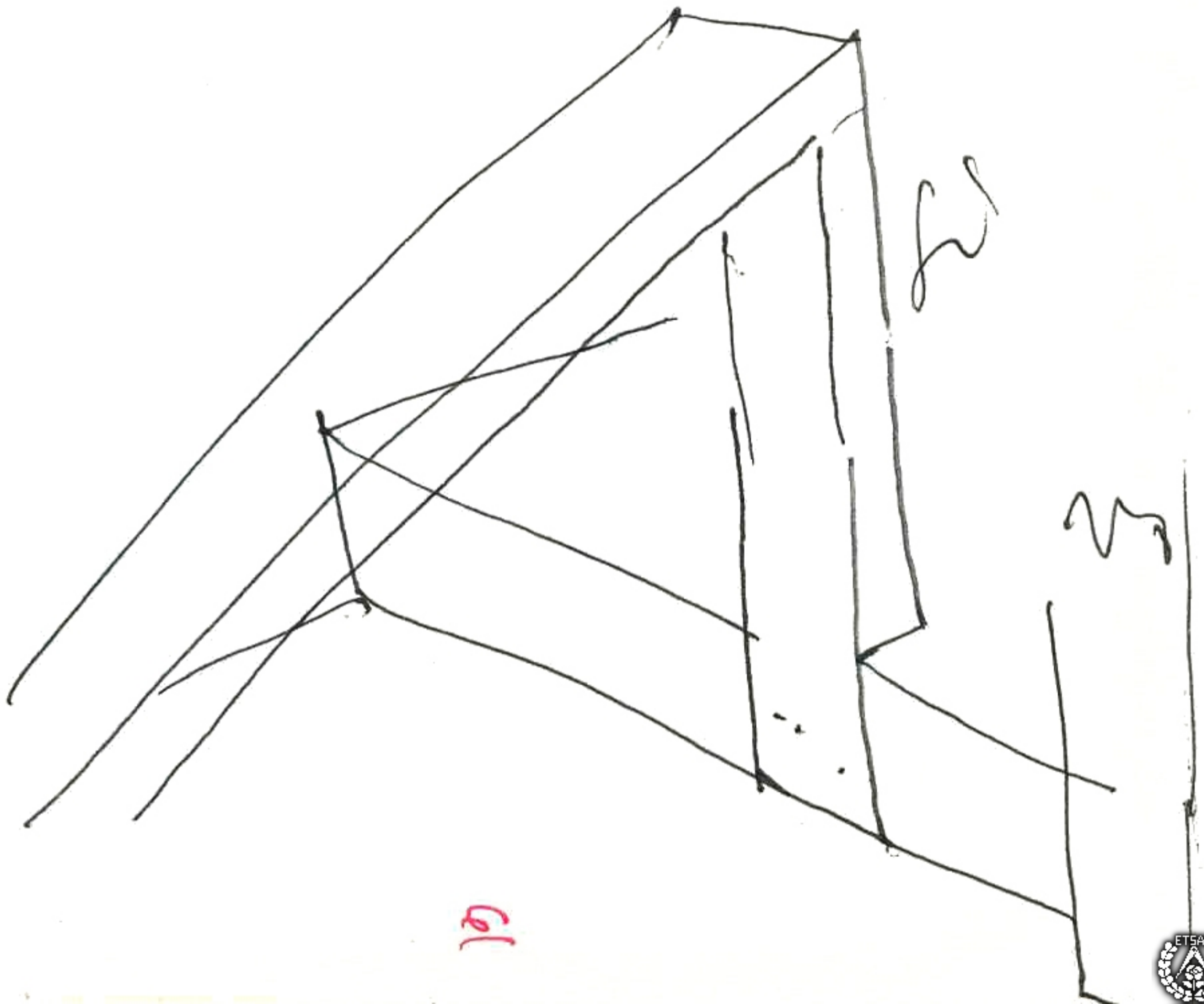

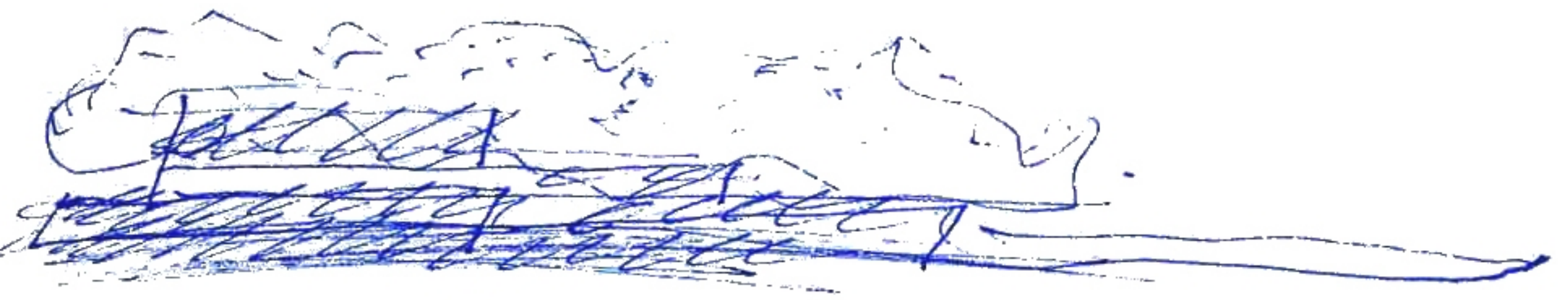

SS

13 julio 2007

67



Material feup - que deen la  
 AHO - 1) grawa por A. 2)  
 Traves Granada. 3) i Tarazona?  
 Arantxa @

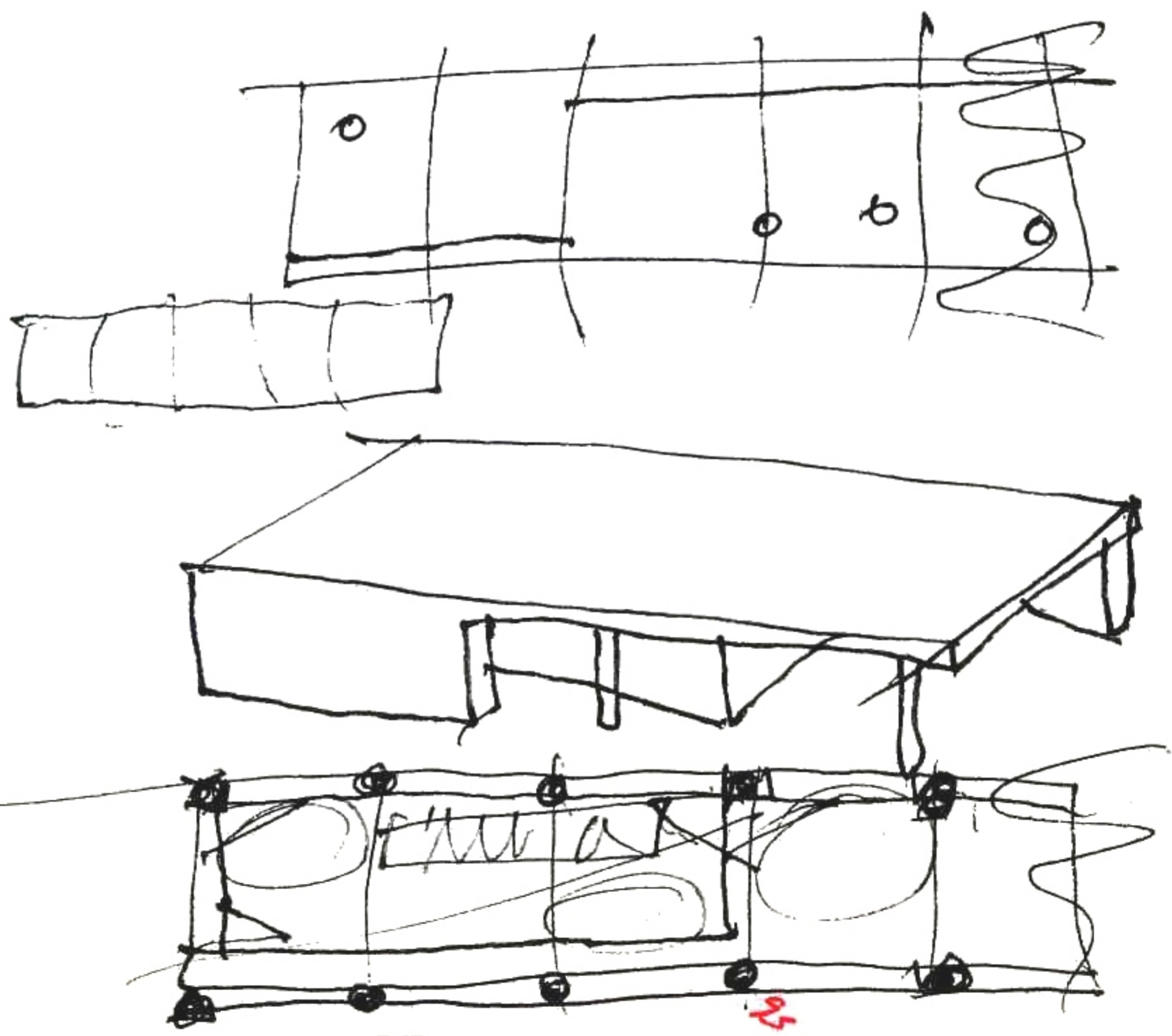



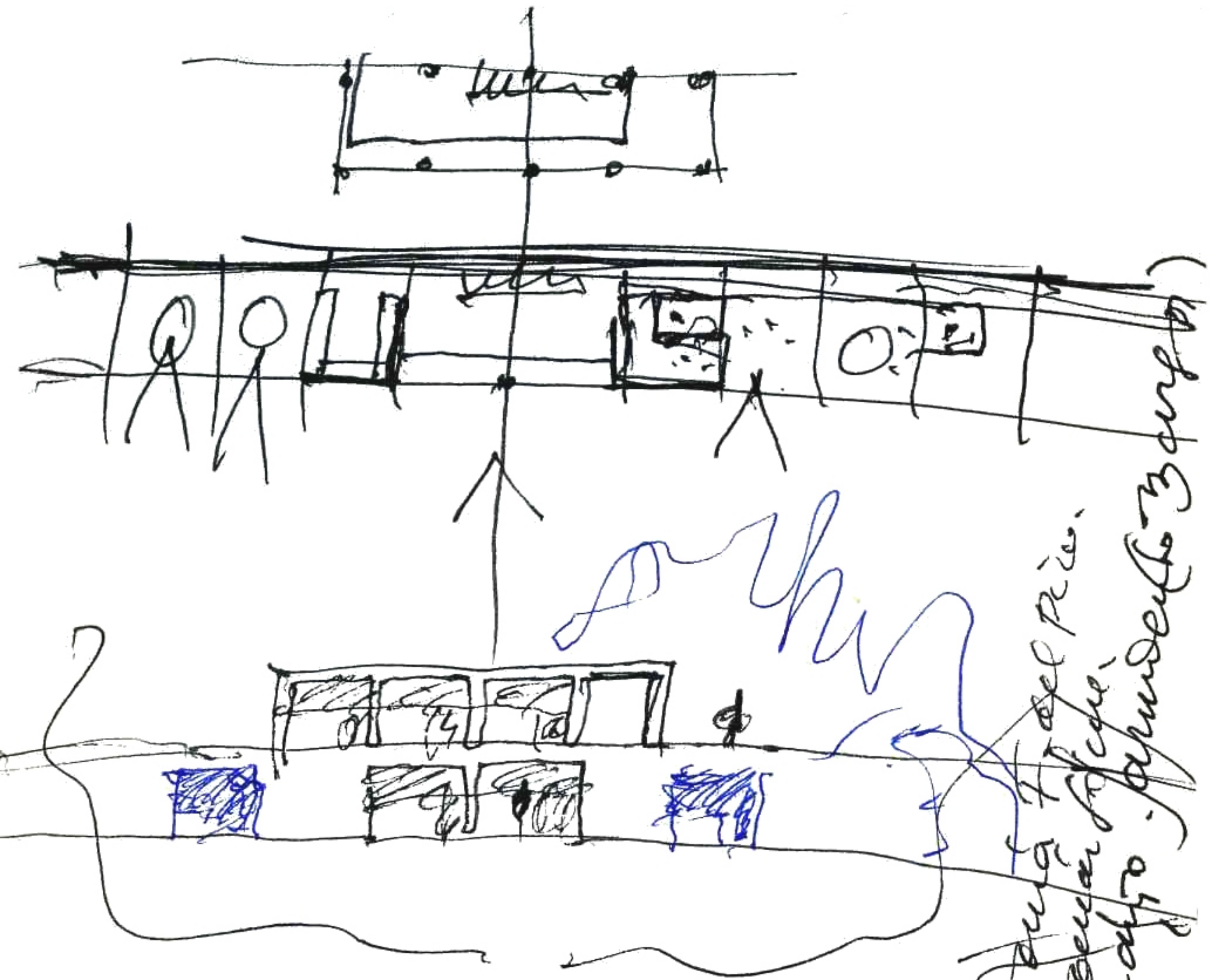

(Punto de acceso)  
 (Cuarto de baño)  
 (Habitación)

55

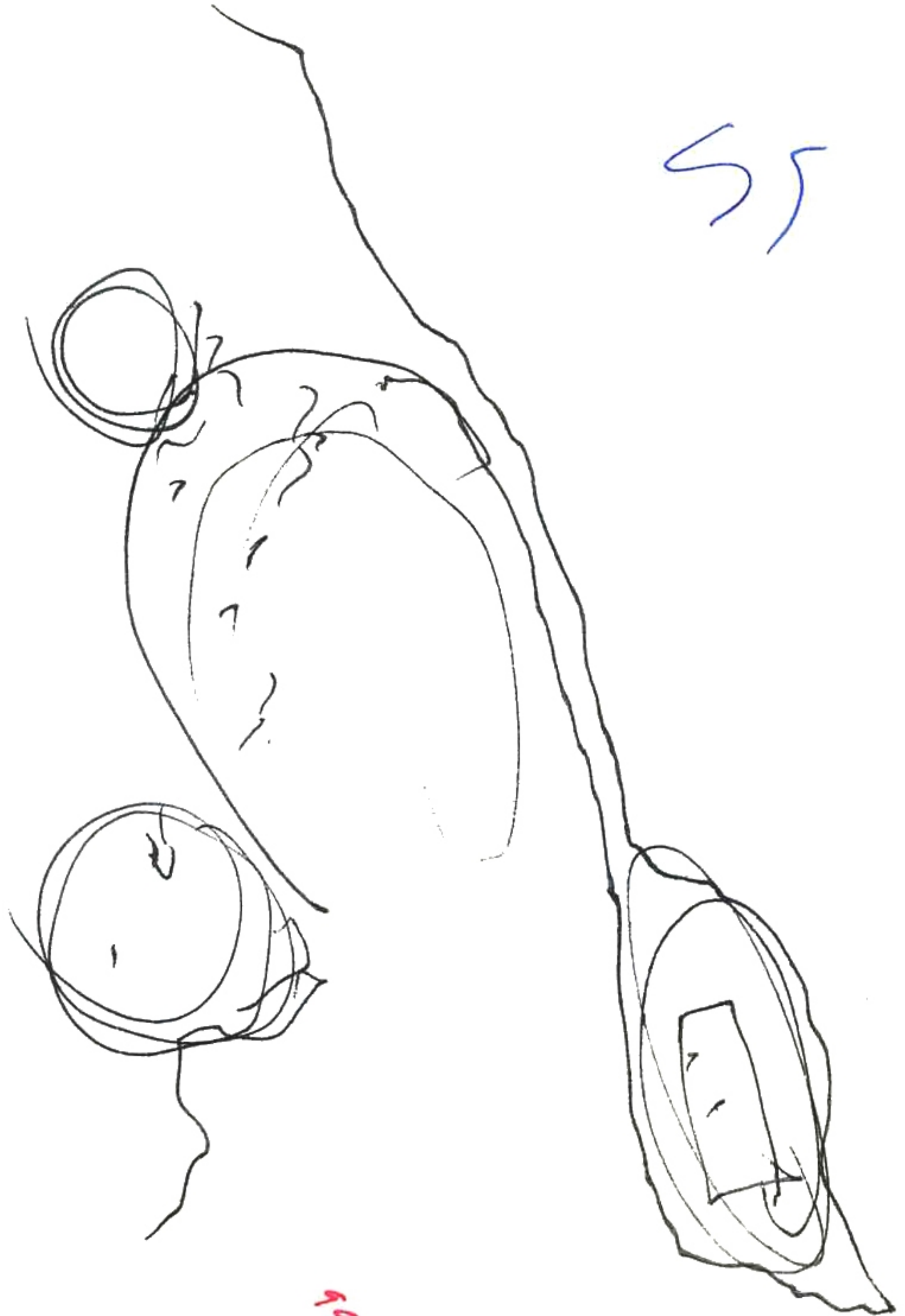

69

MA

19 julio 2007

en Granada.

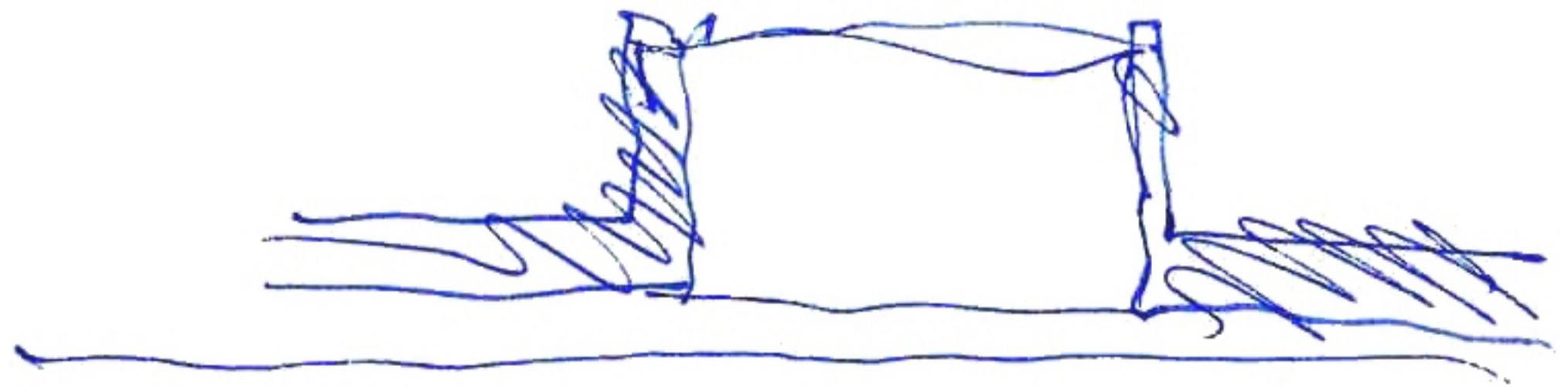

boquete



calle.

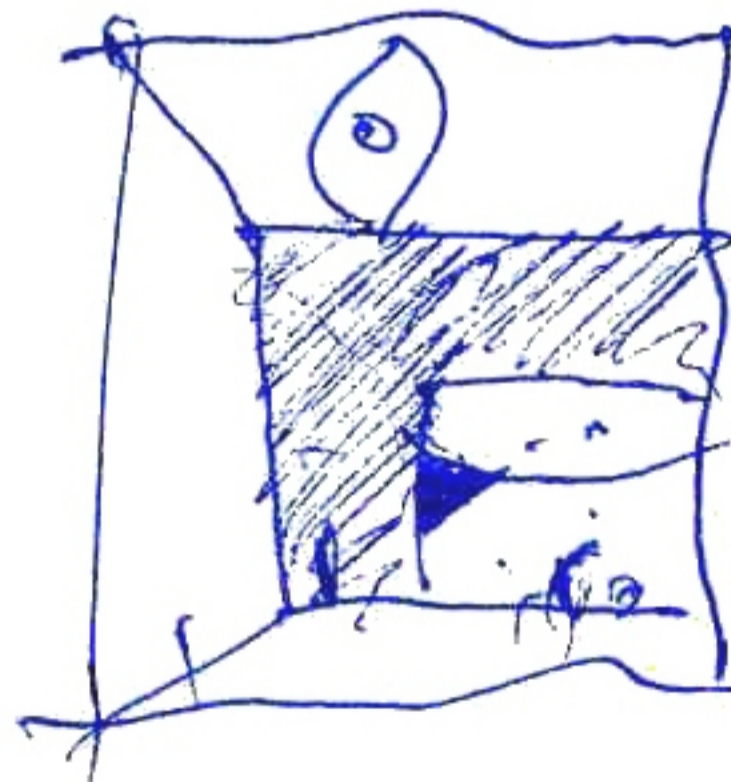

MA

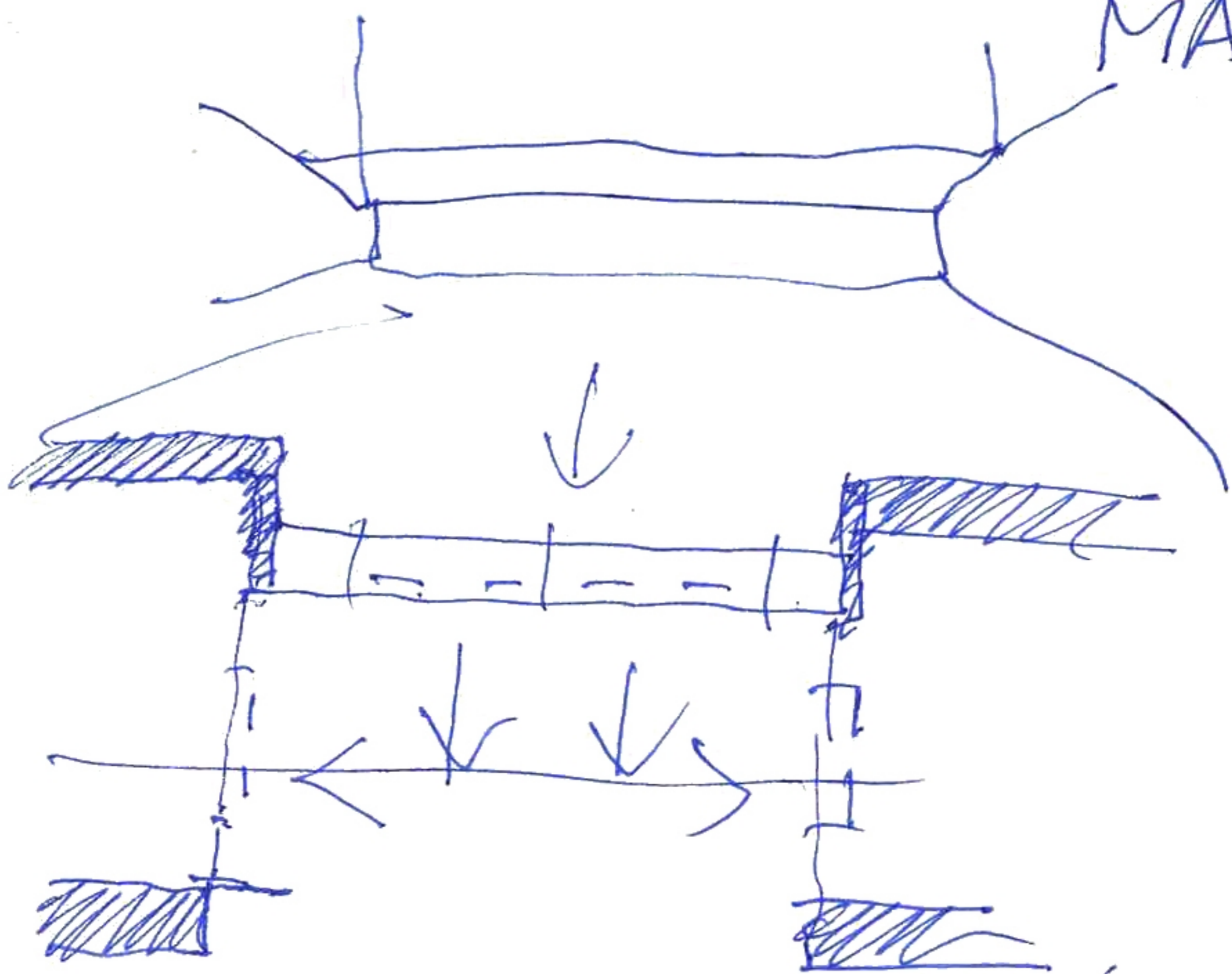

entrada

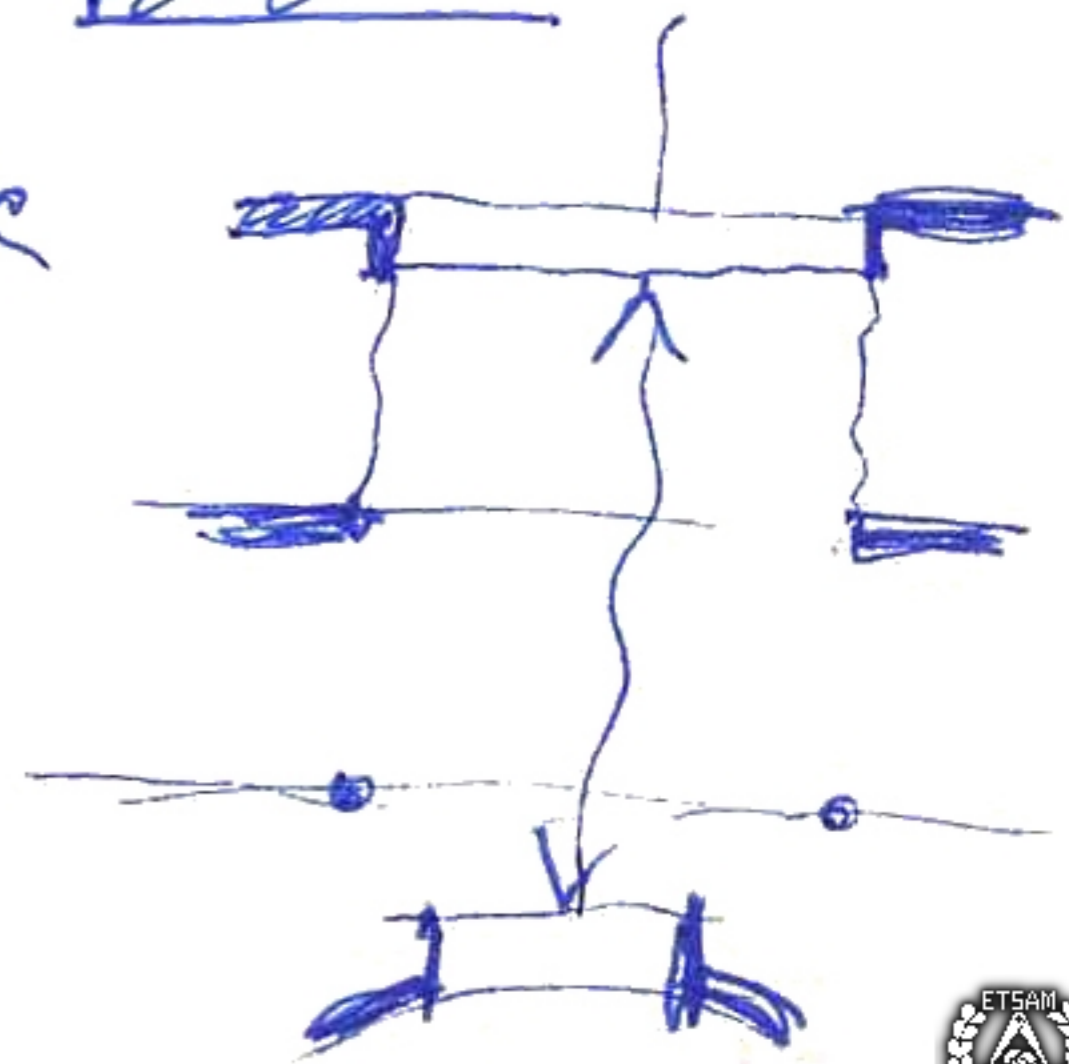

19 julio 2007  
en franquía

101



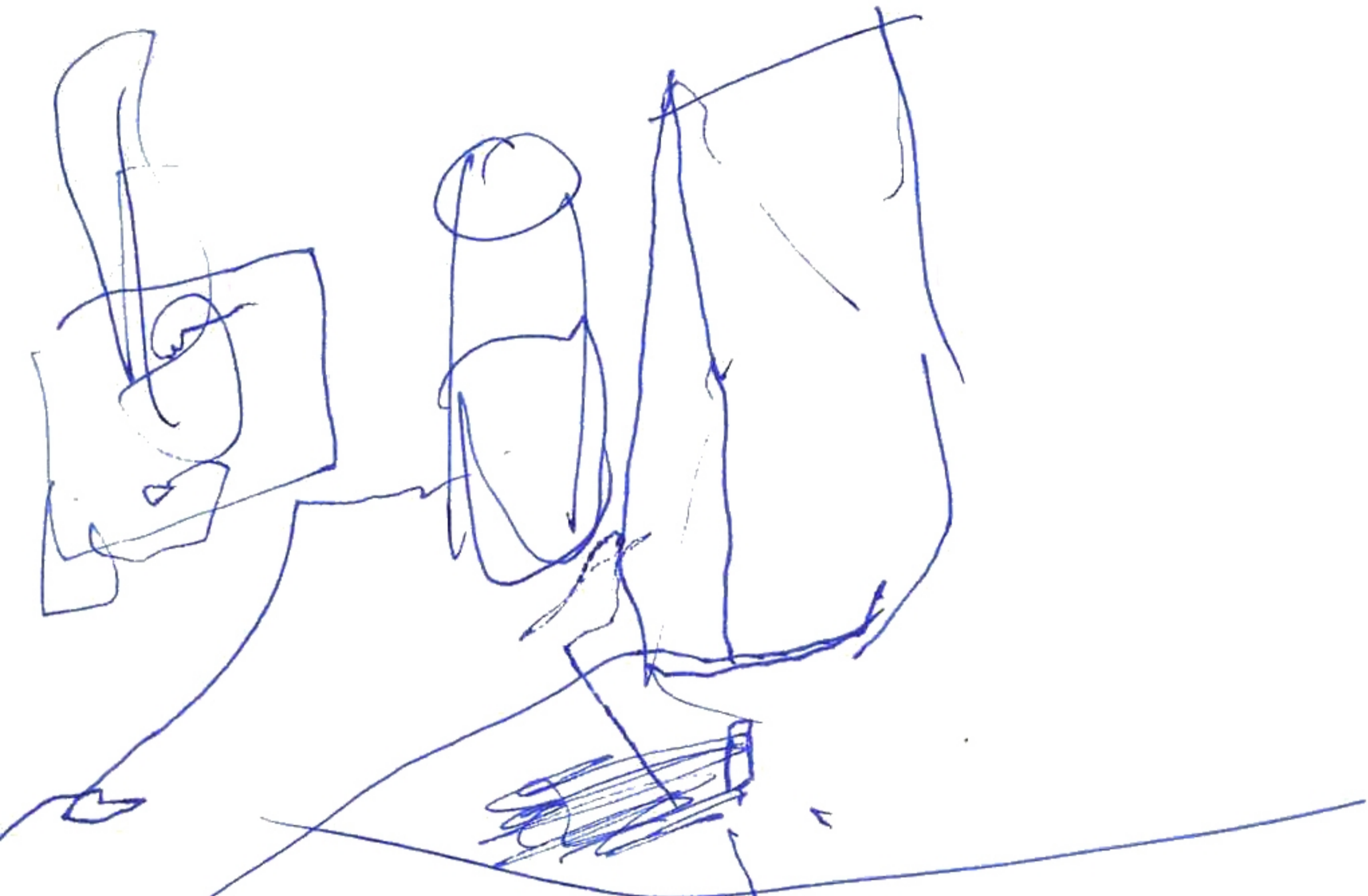

Human muscle  
by stress

55

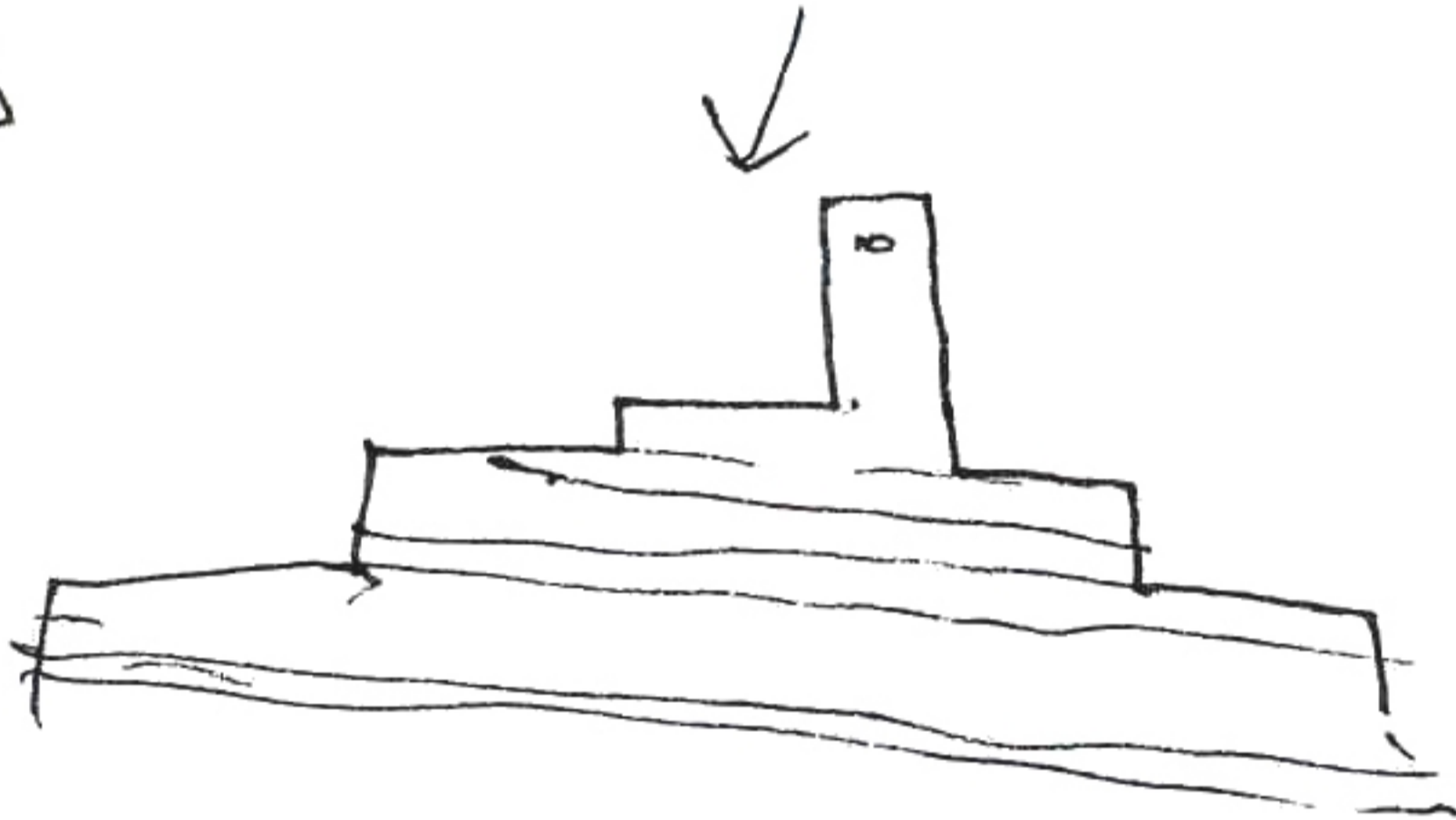
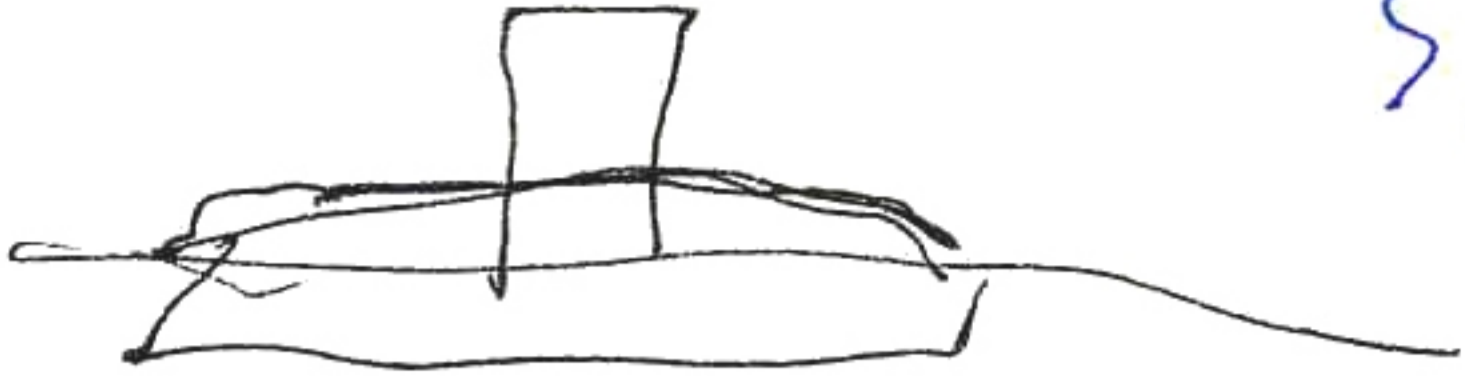

85



en cadot:

28-07-2007

calivata  
Versalle

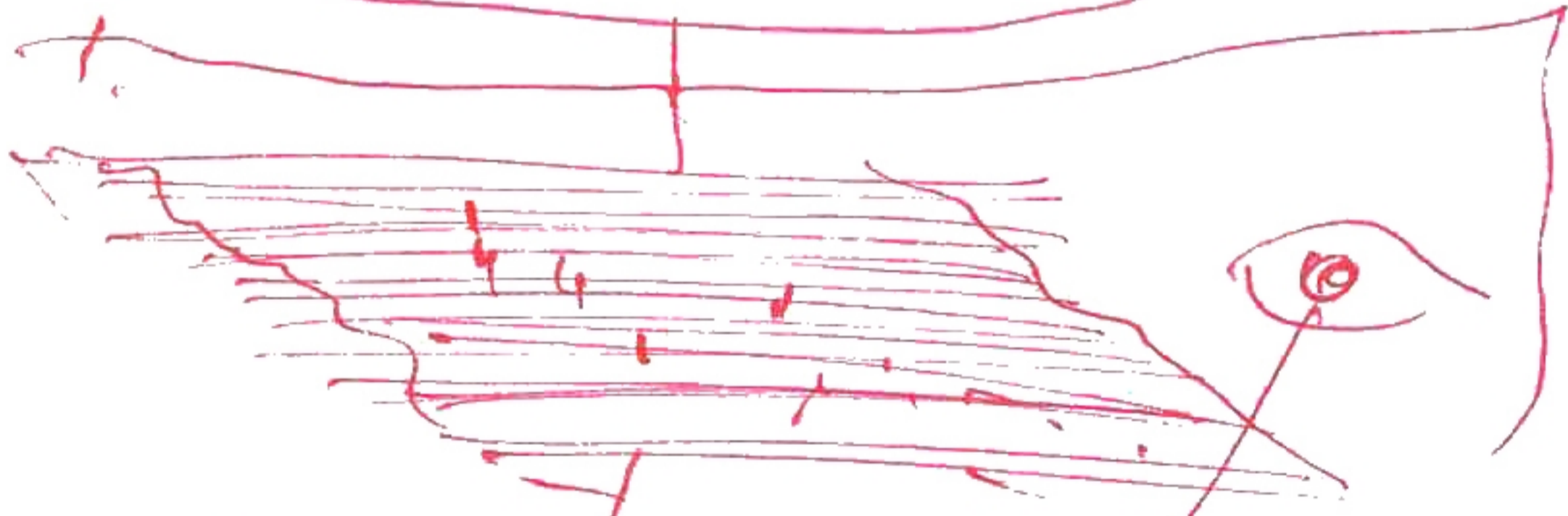

fotia  
Coppola

Versalle

busca

- lucas.  
- francie

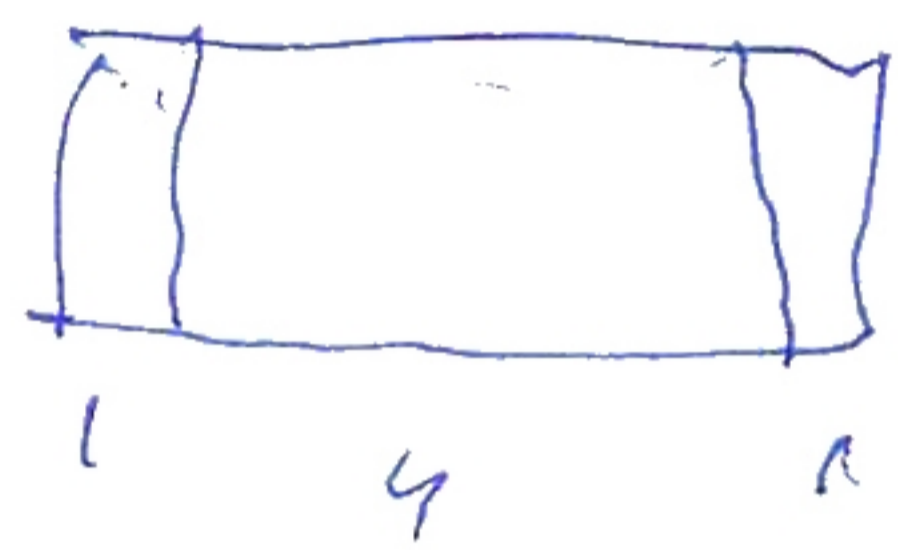
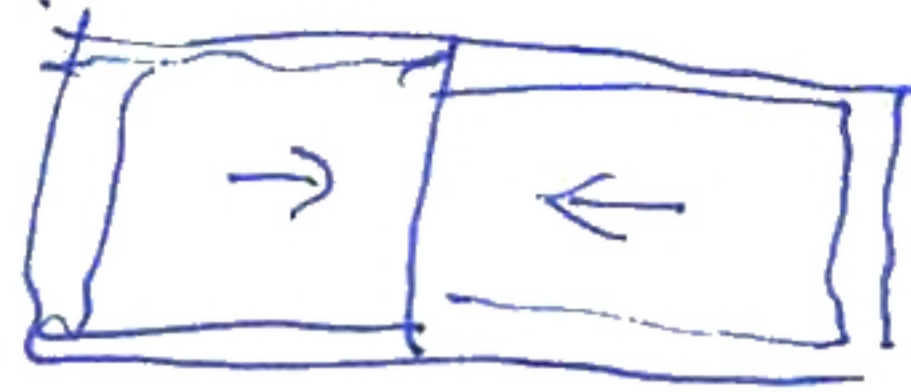
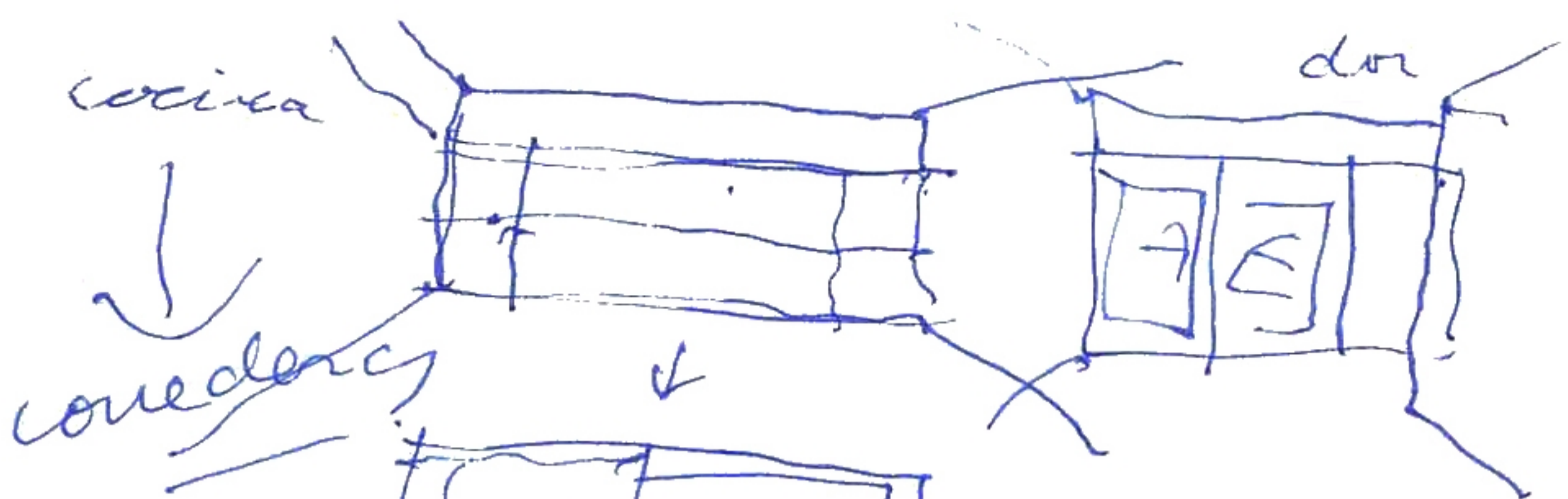

Carpintería

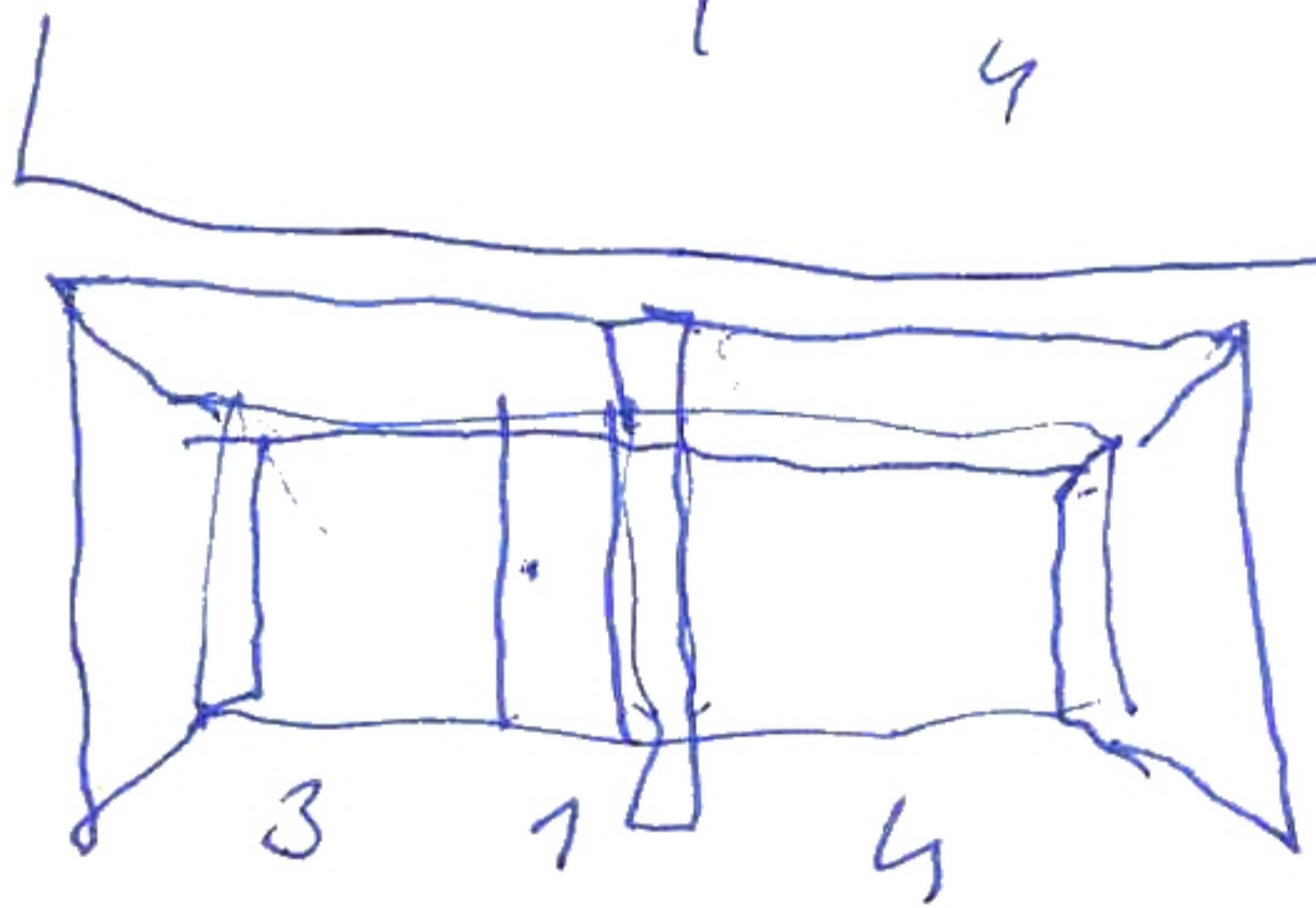

Casa de Blas  
Casa Rufo

30 fotos <sup>123</sup> 2007

RUFO  
HOUSE





LANZAROTE

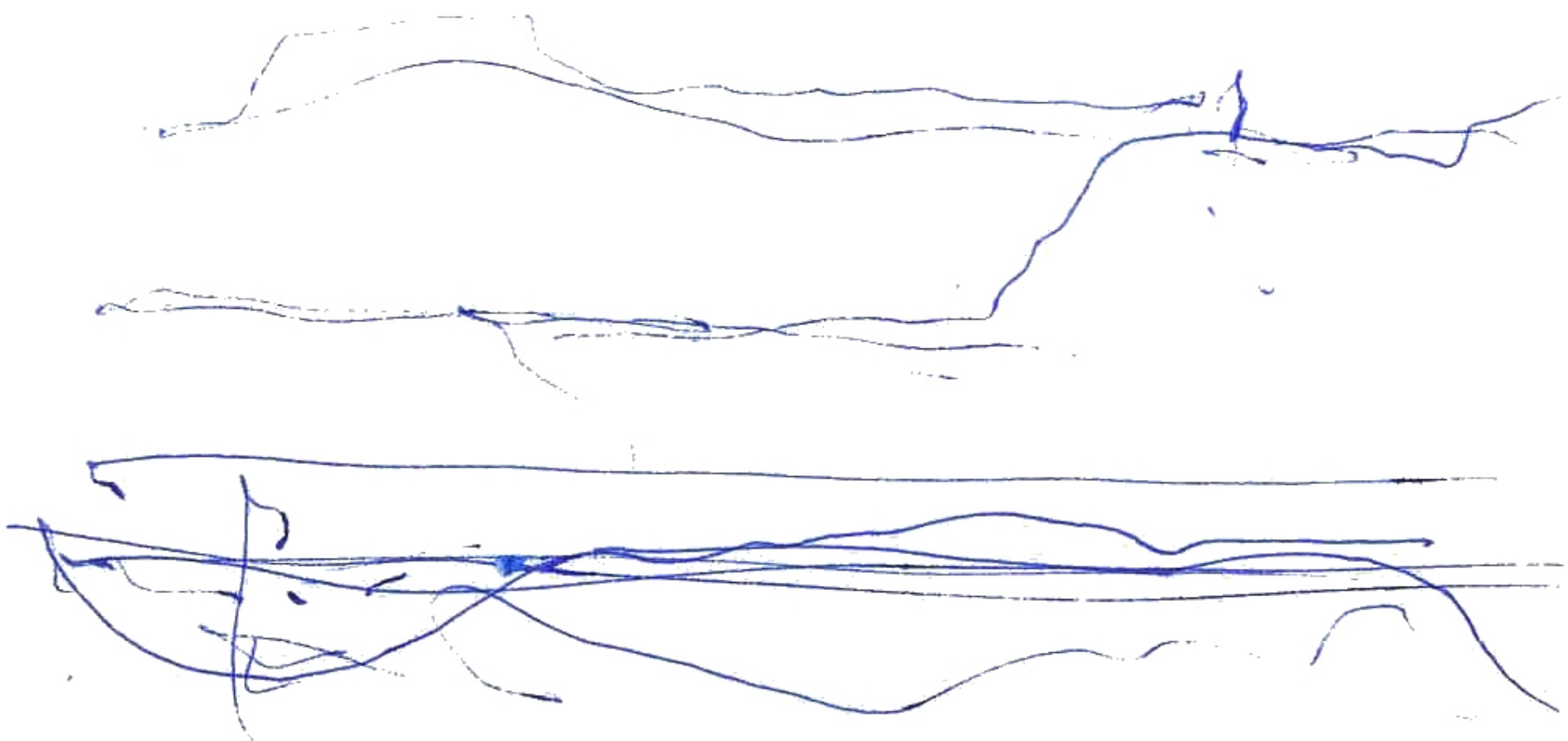

LANZAROTE



122



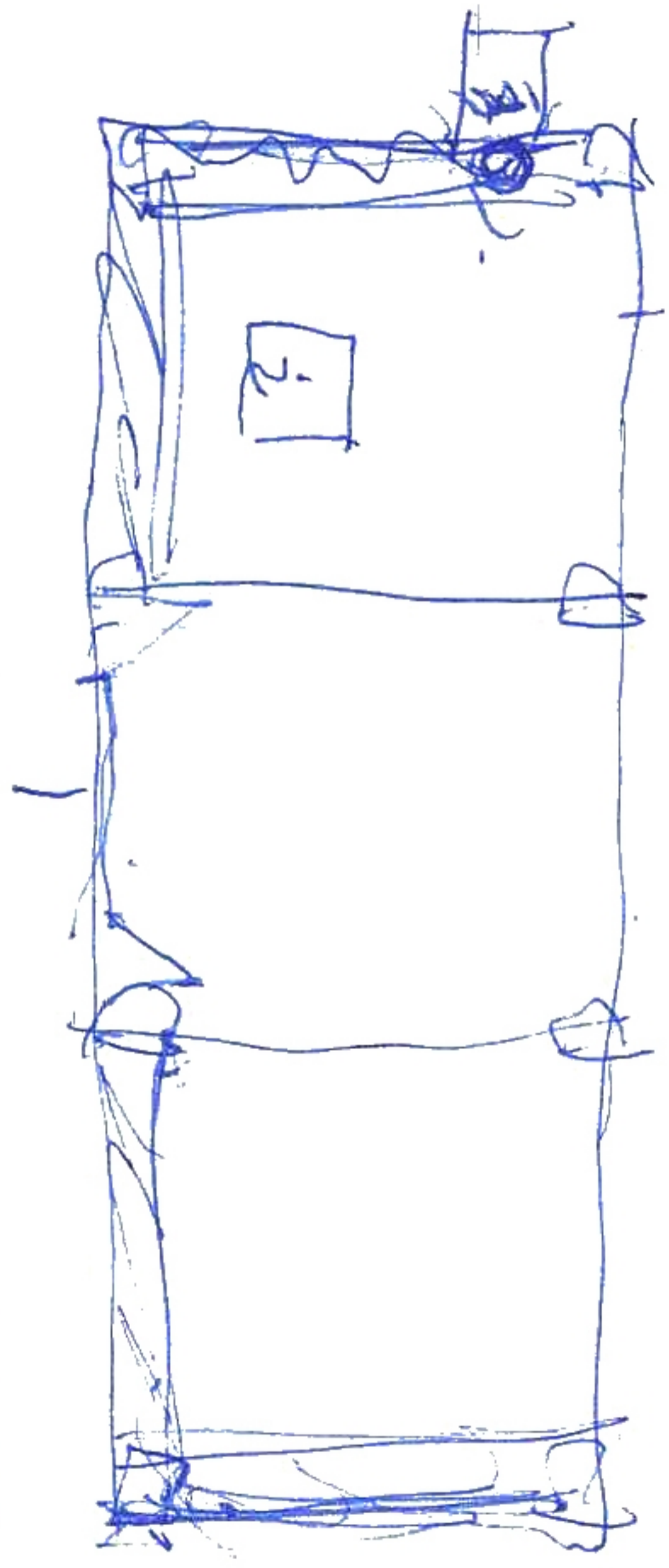
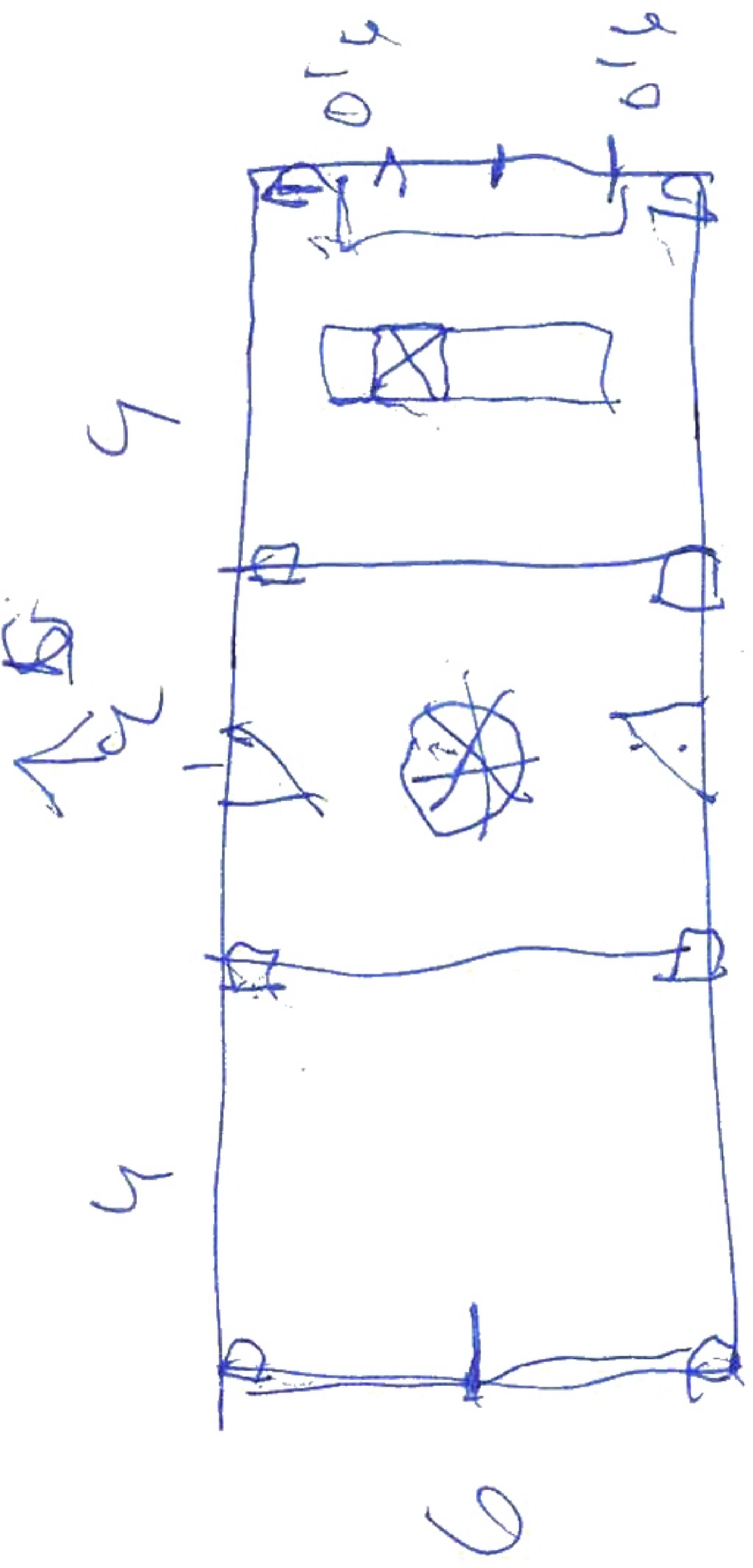

N T

Paragorak

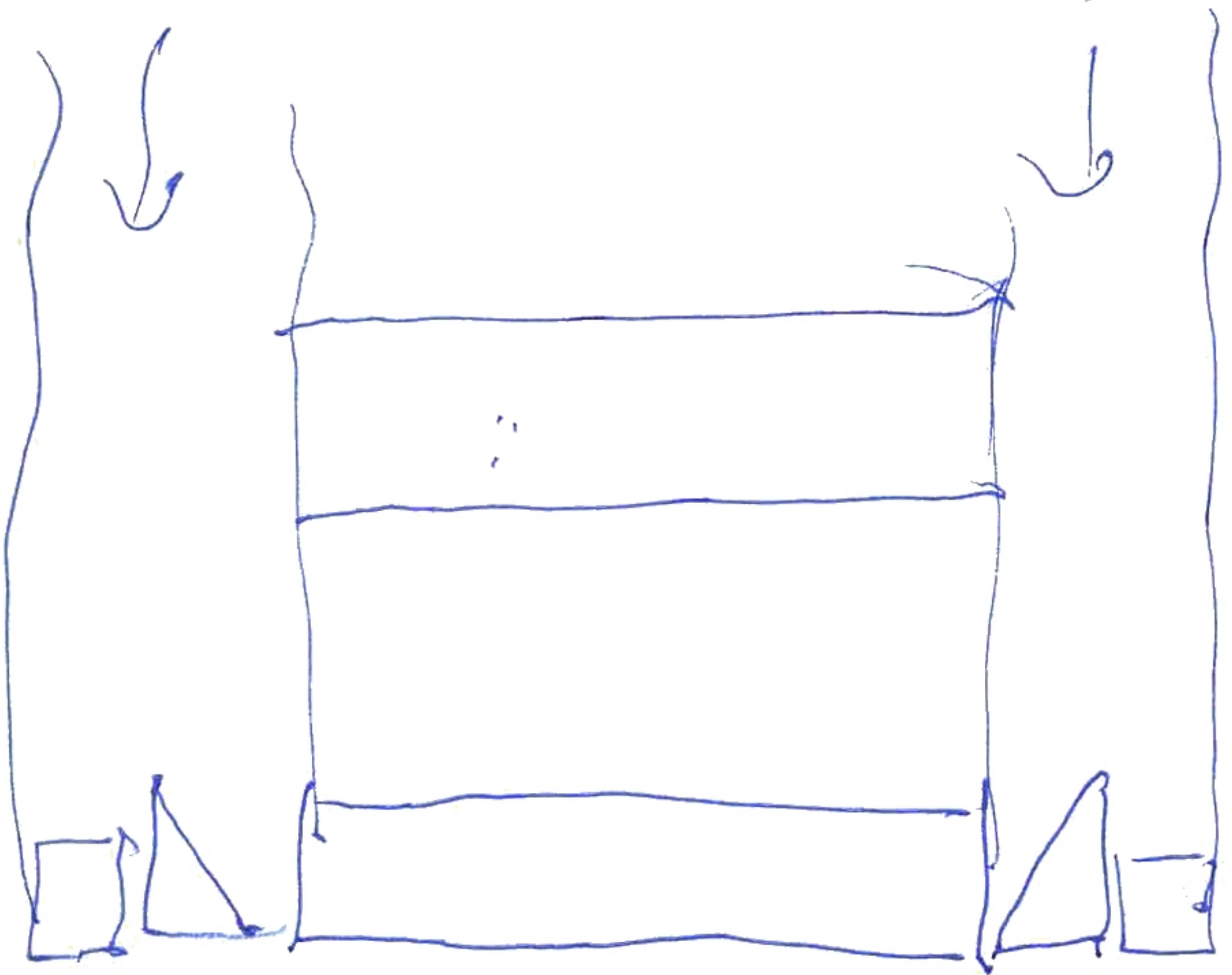

129

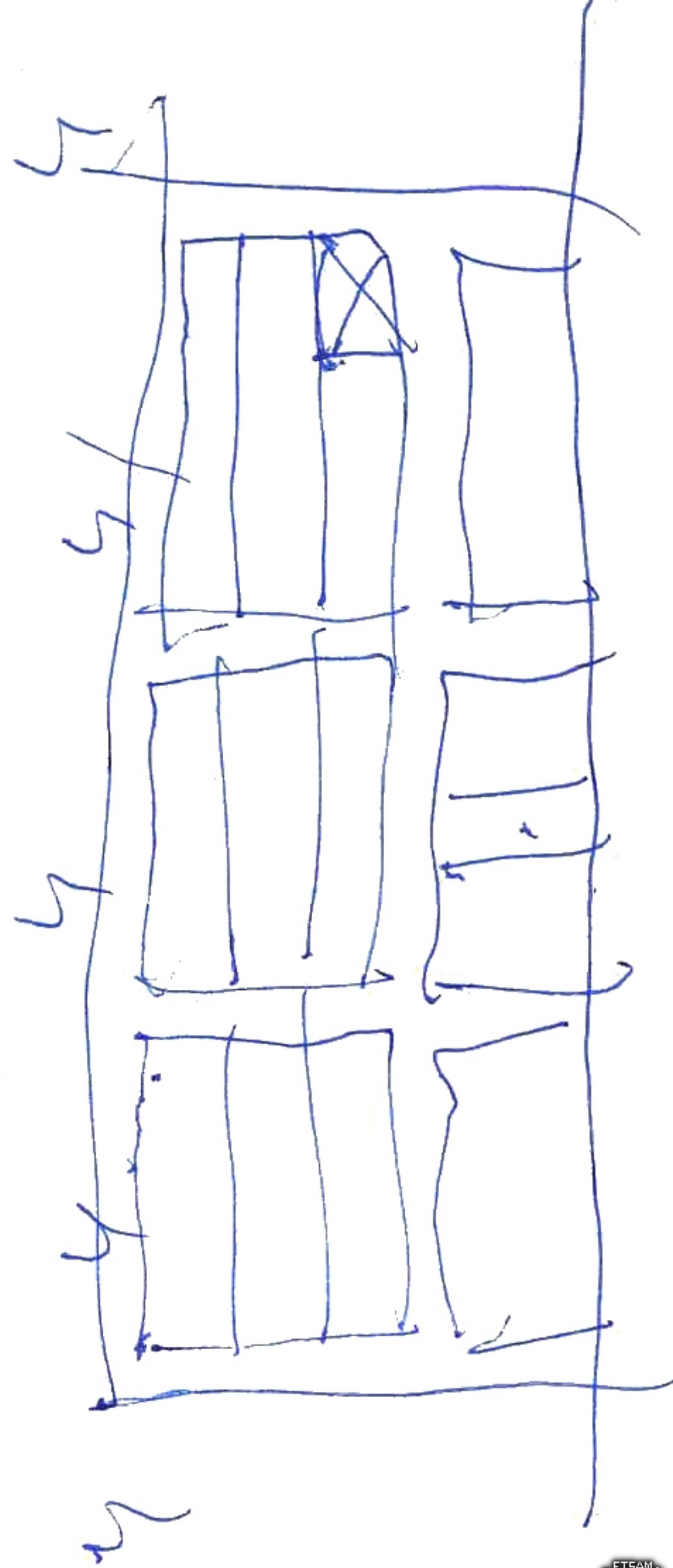
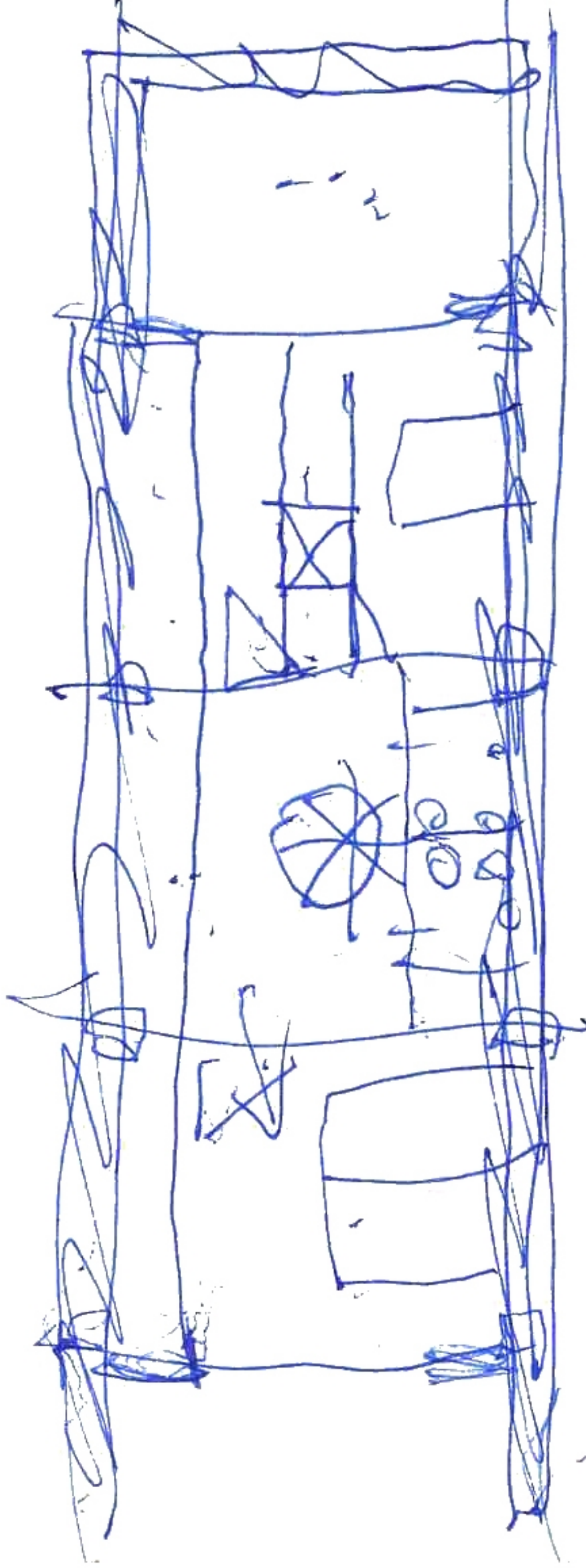

Examinator  
27

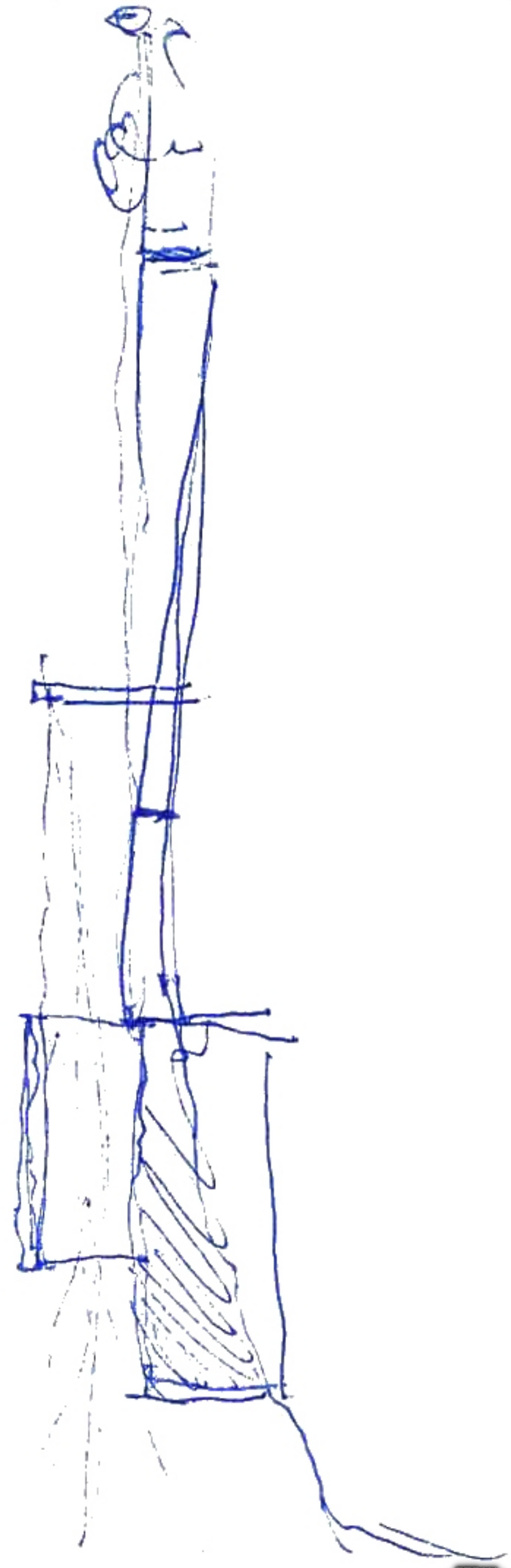
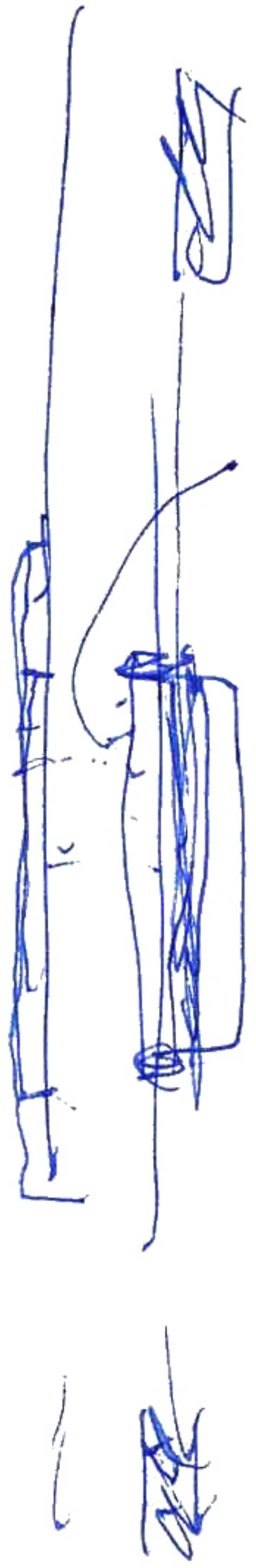
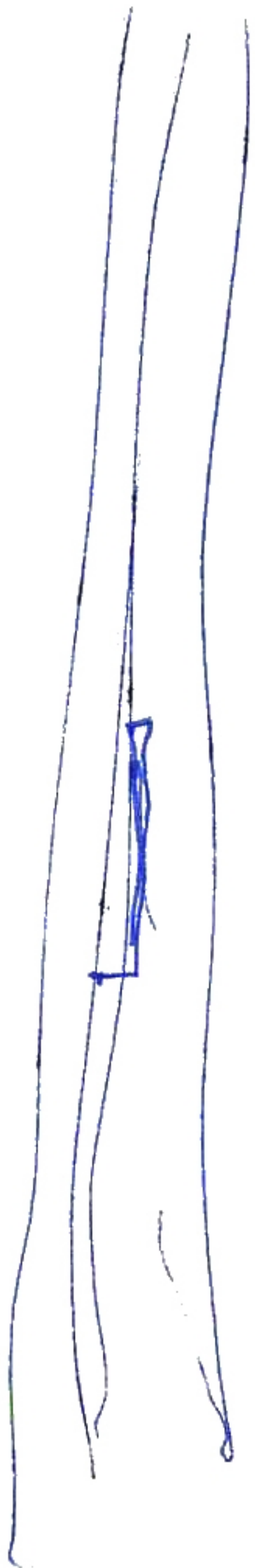

QUE CLARA SON LAS IDEAS.

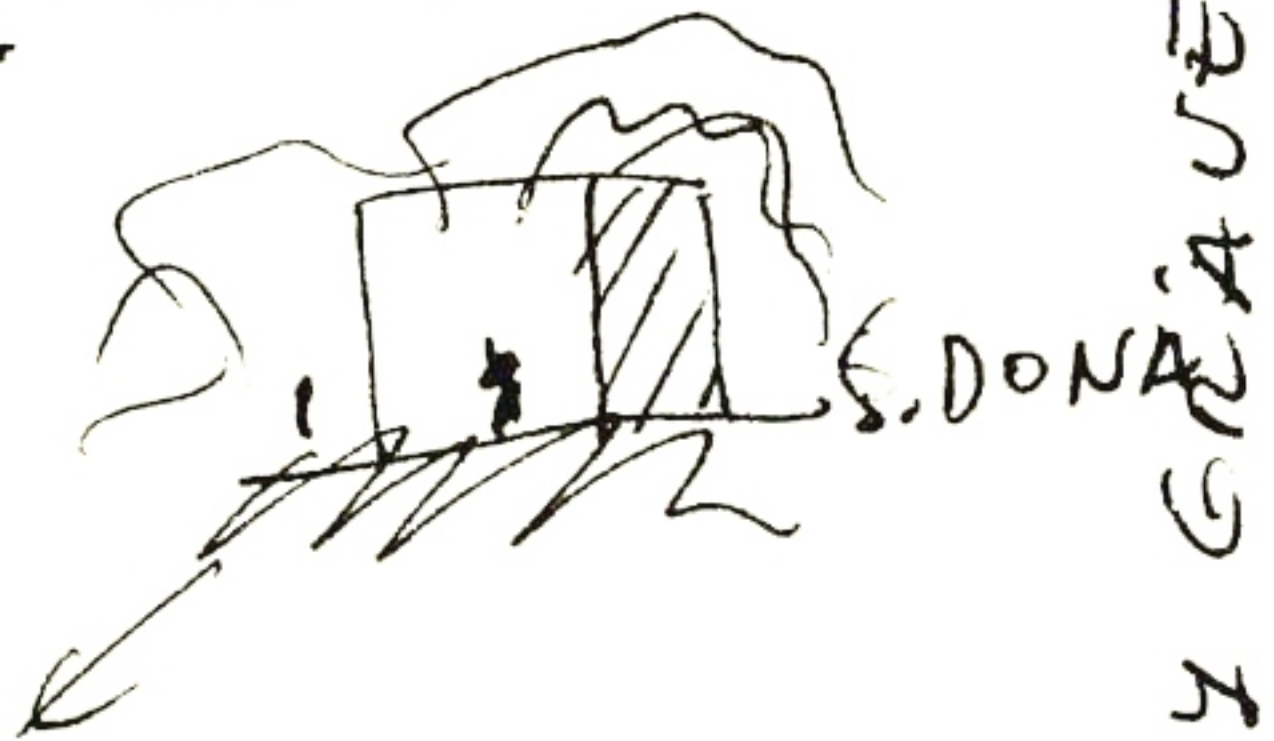
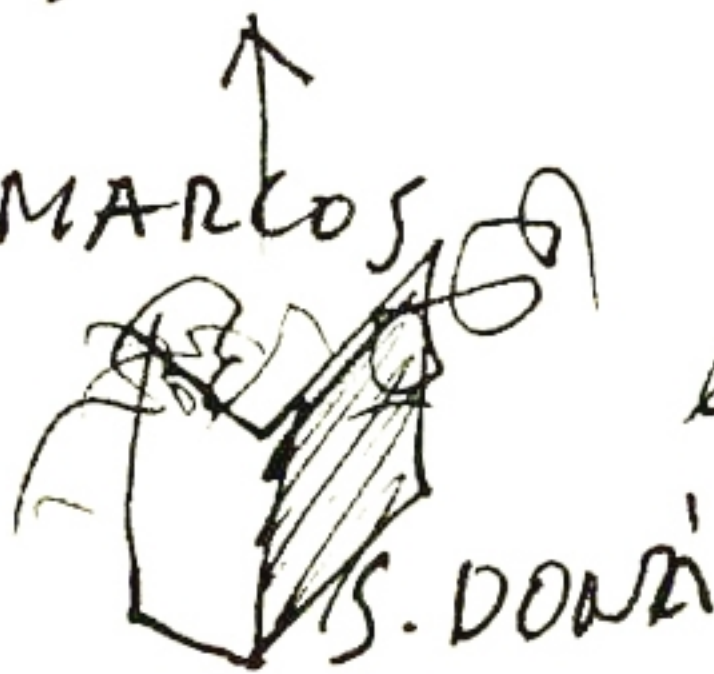
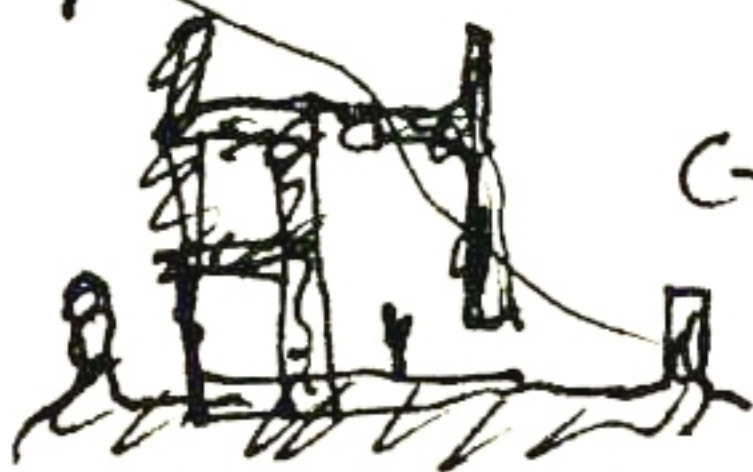
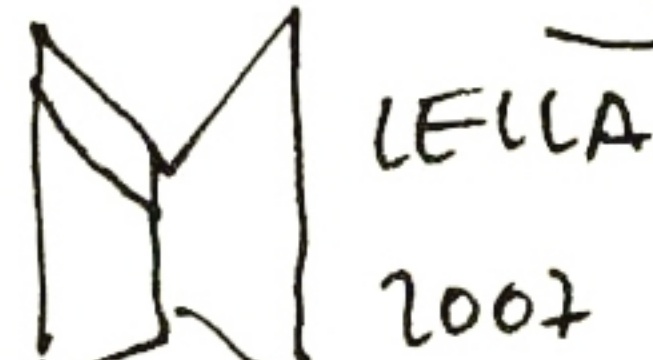
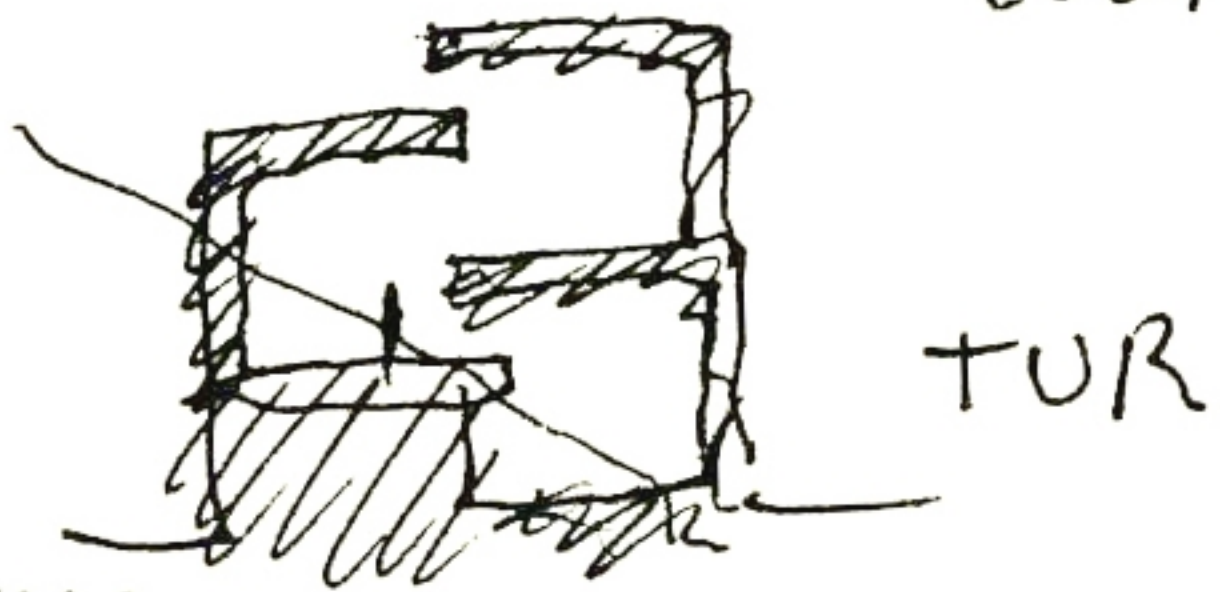
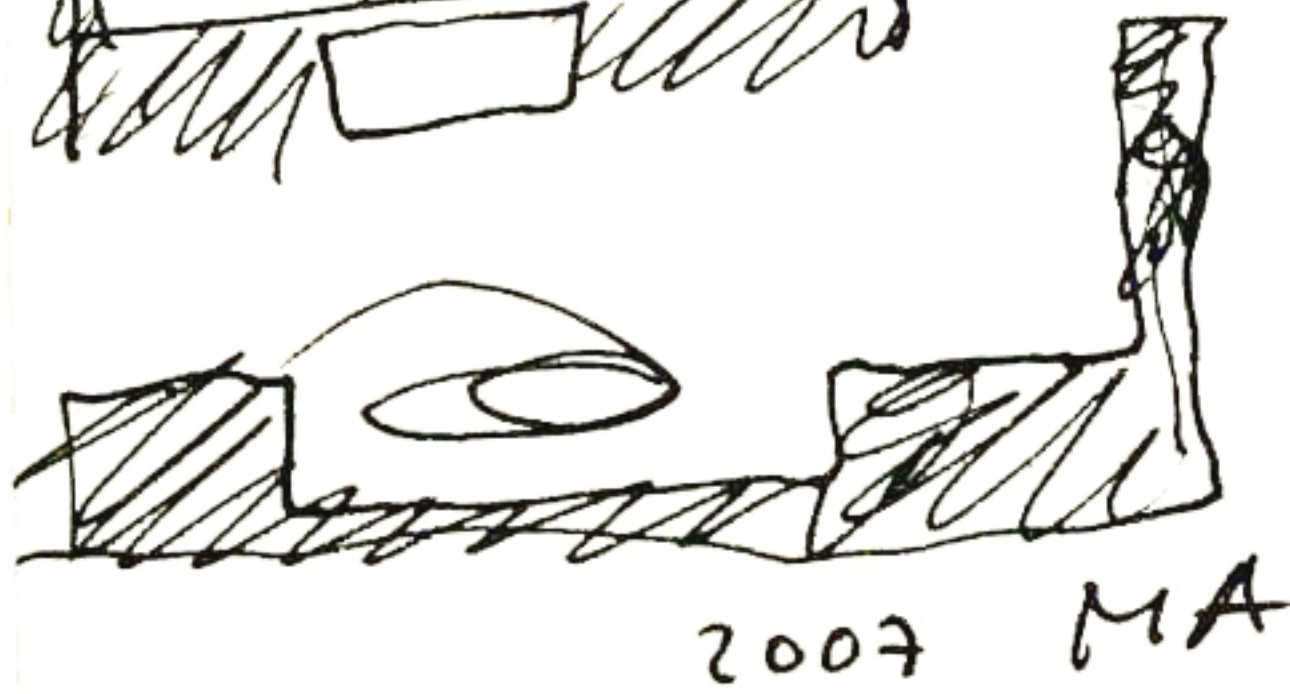
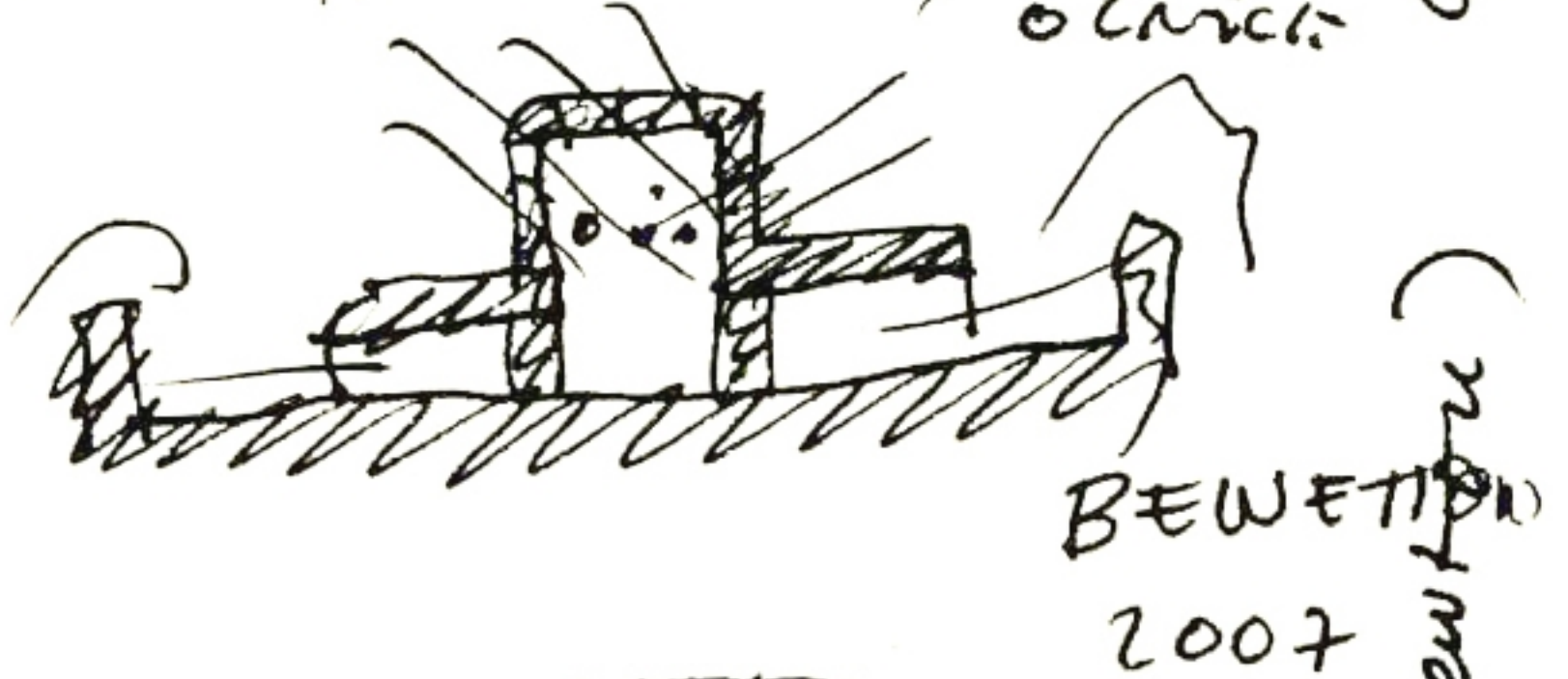
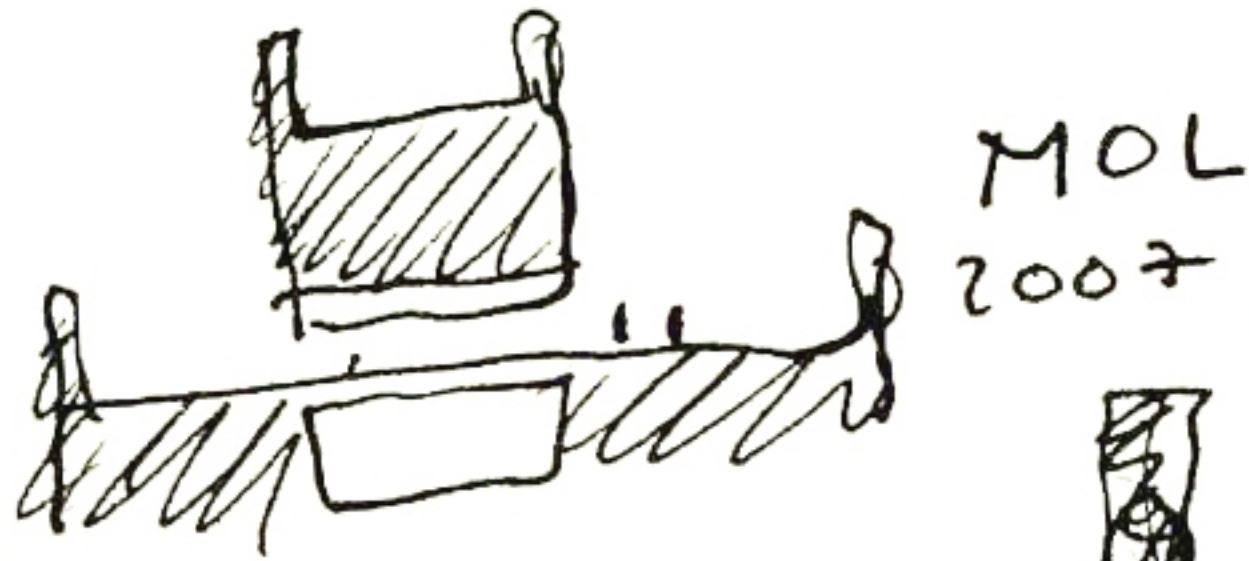
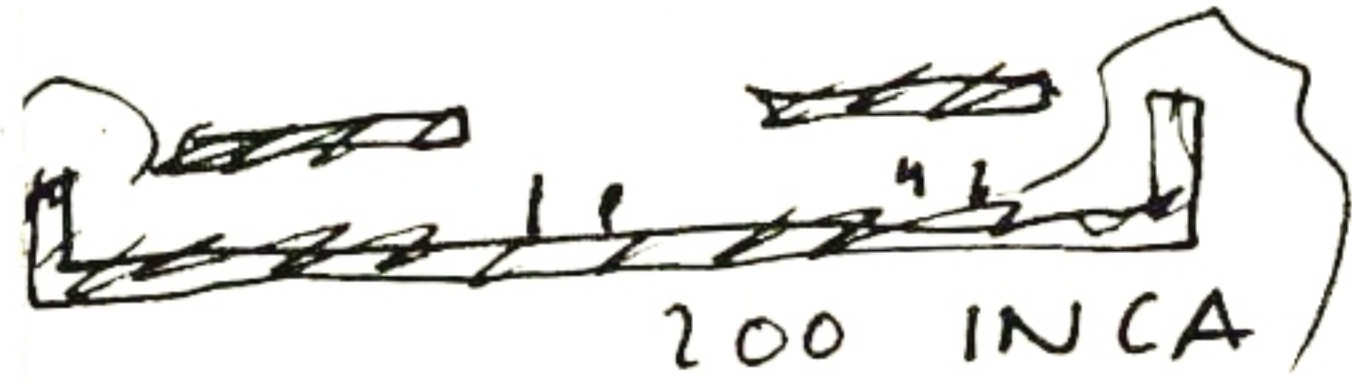
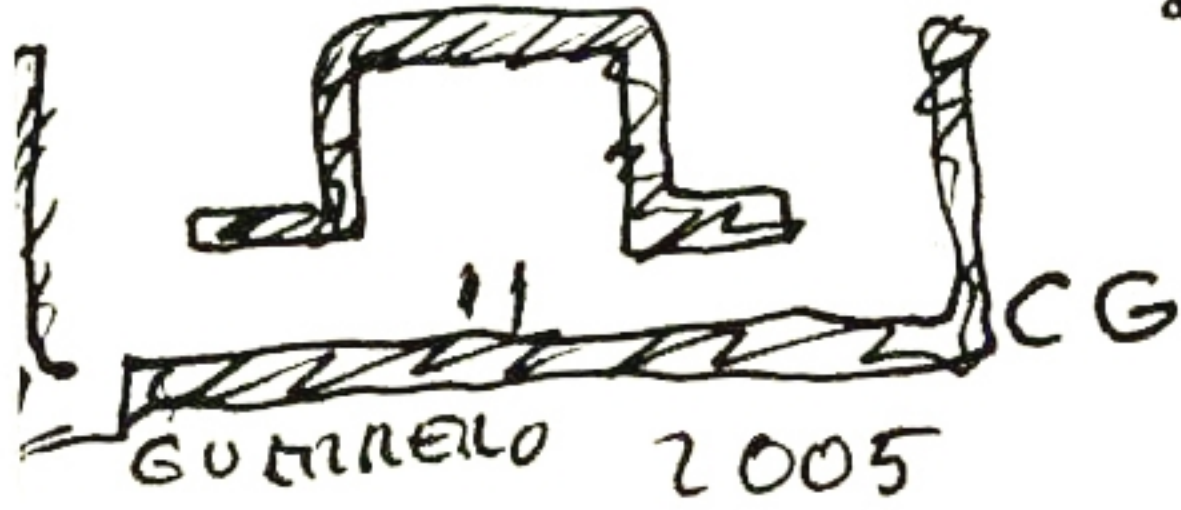
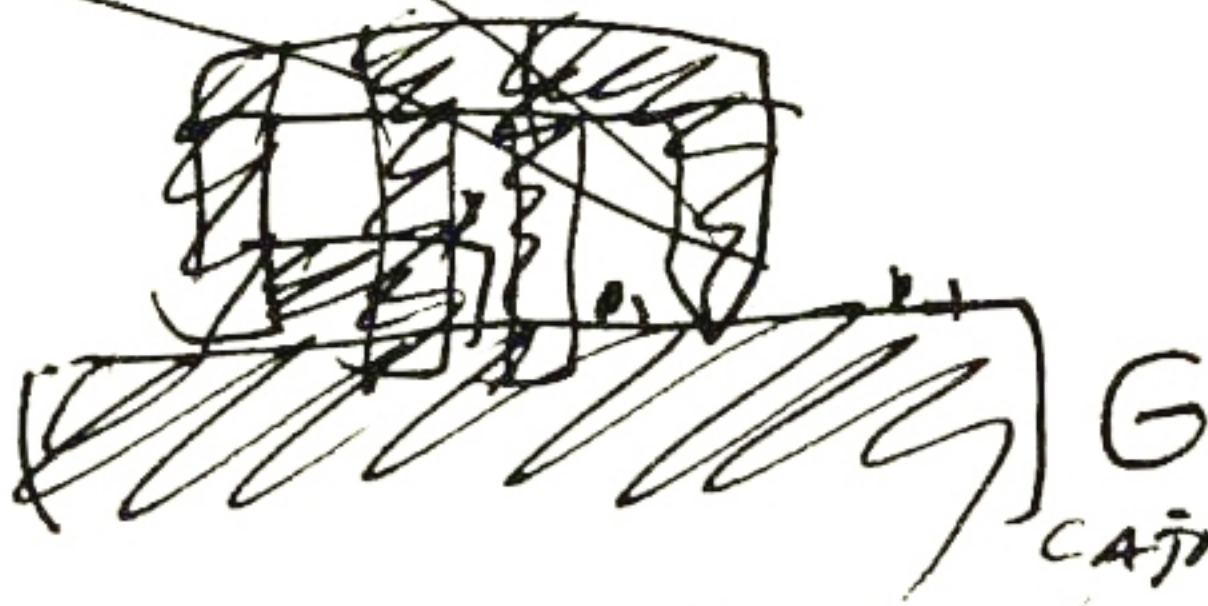
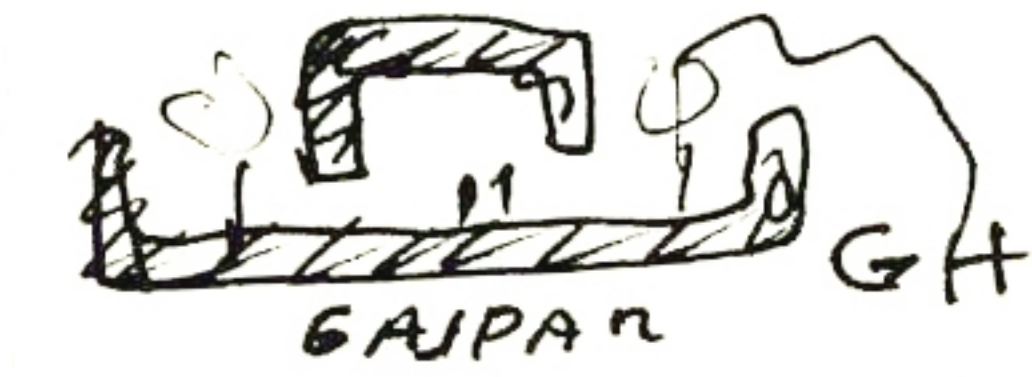

LWZ y GRAN UVA CADIZ. 22 de Diciembre 2006

(Descartes)  
CUANDO SON CLARAS Y DISTINTAS

