

5

[September 9. 1994]

July 30 1995

lett dlc
1994 - 1996

GS

GS

x

Universidad ETSAM. CASA AL REVÉS.

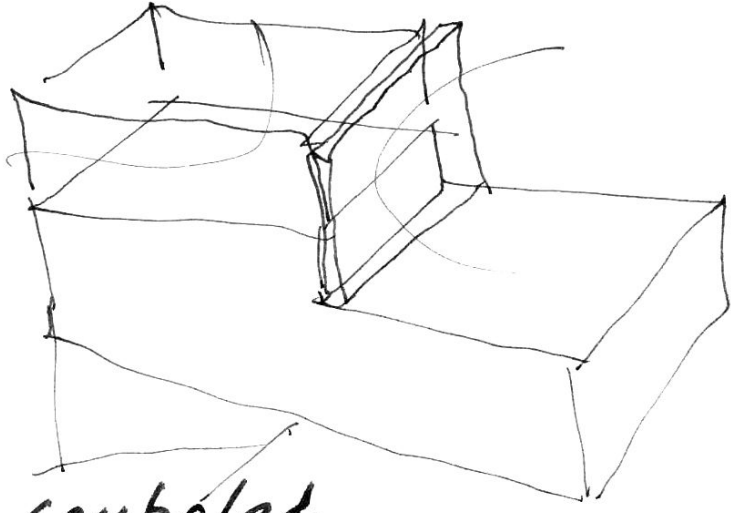
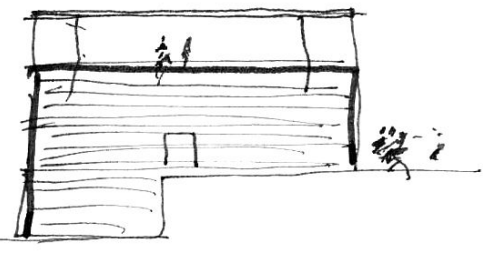
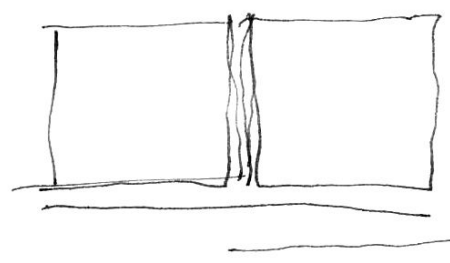
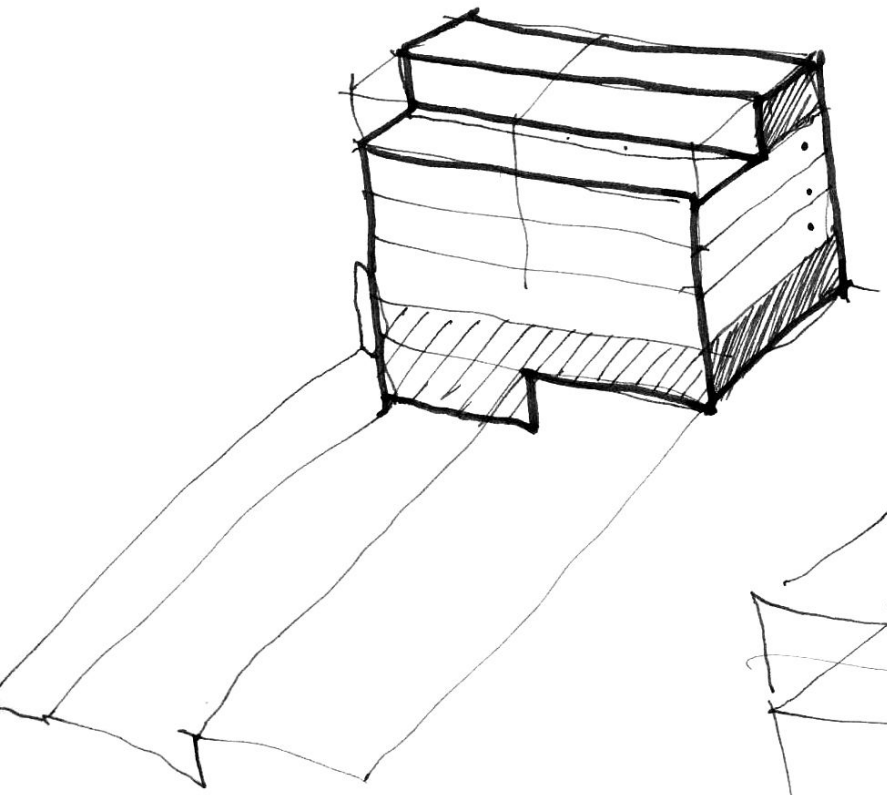
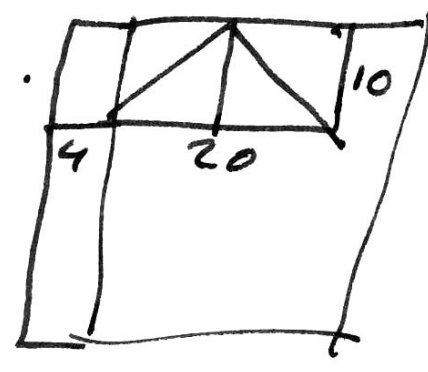

- 1 - ascensor
- 2 - climatología controlada
- 3 - luz

<p>ambia</p> <p>[racional luz</p> <p>claro</p> <p>TECNOLOGIC</p> <p>transparente</p>	<p>abayo</p> <p>curios</p> <p>fombra</p> <p>oscuro</p> <p>STERNEDON</p>
---	---

Ca'du? October 11. 1999.

PAGO-MERILL 5

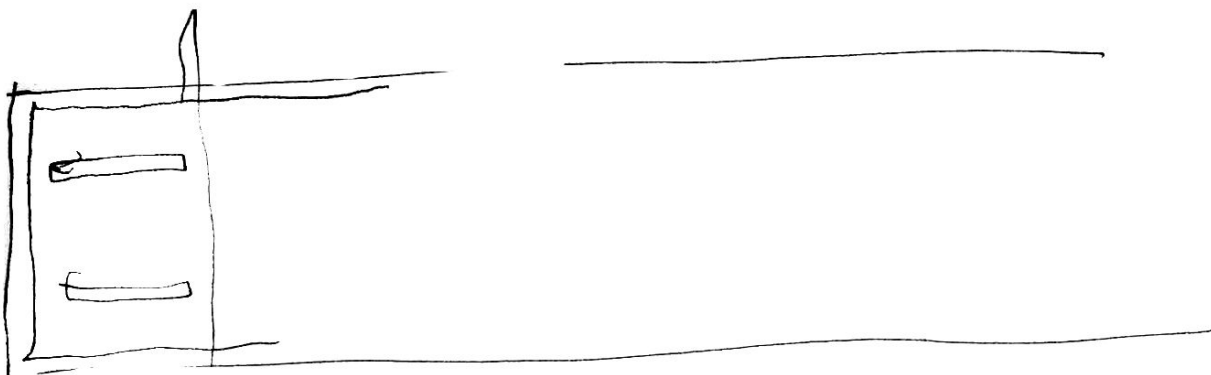
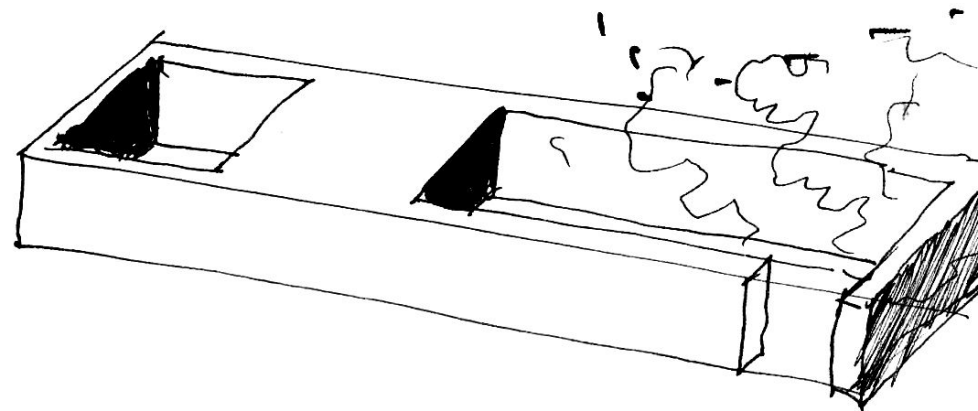
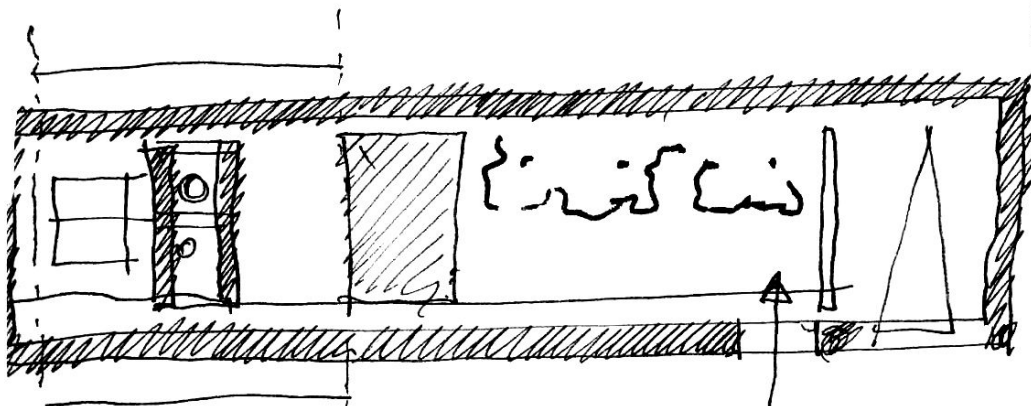
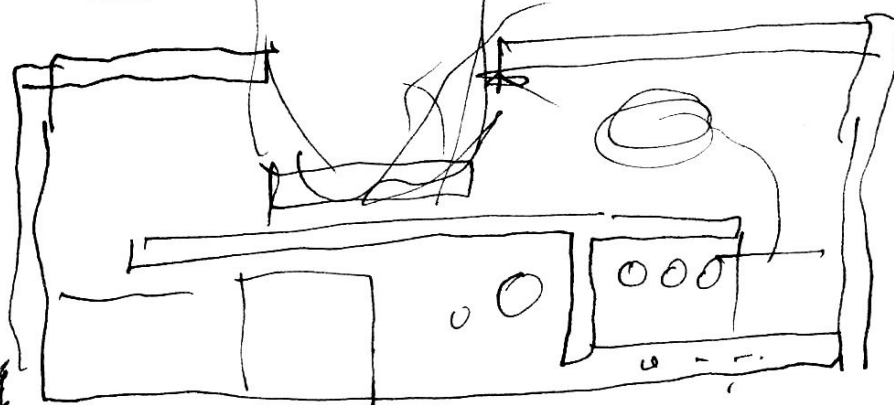
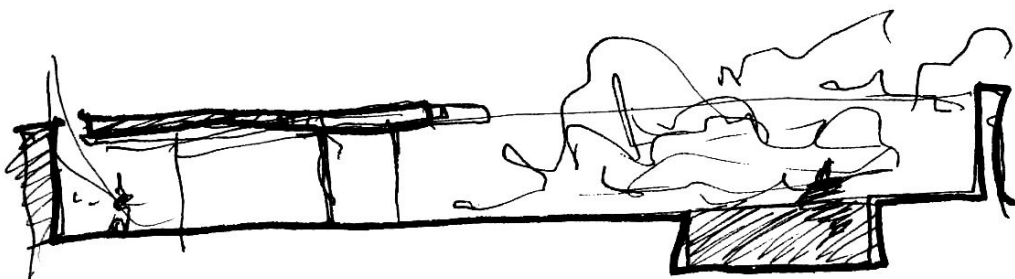
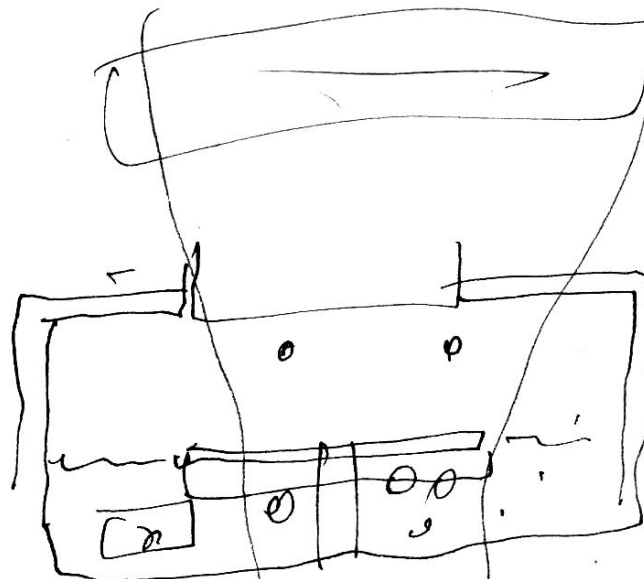
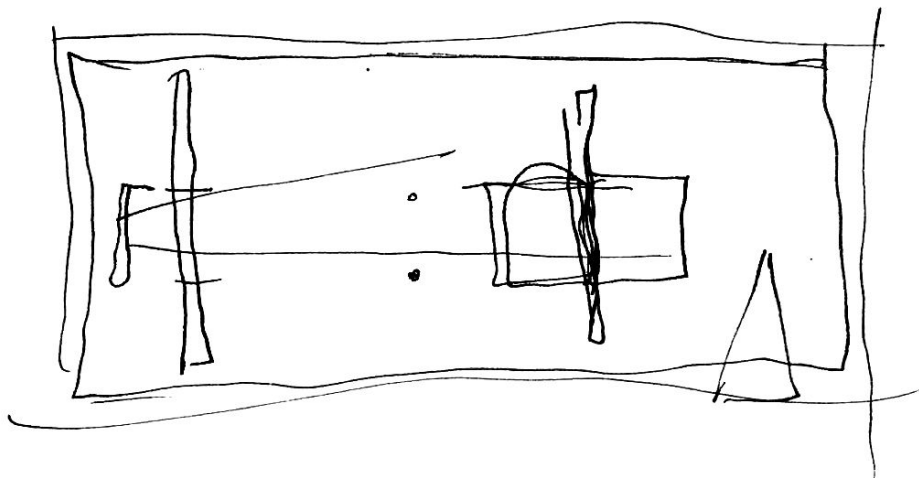

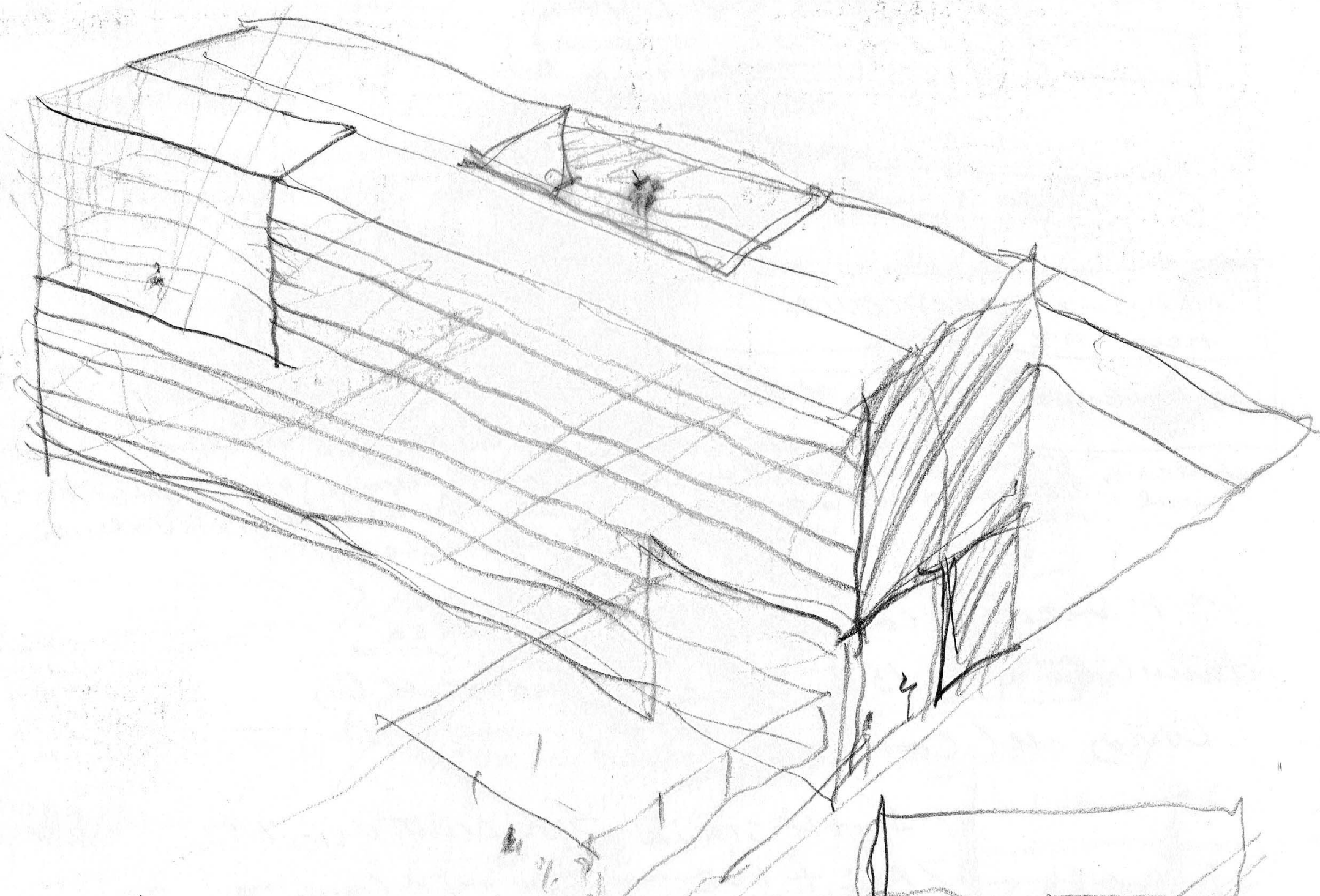

Almoran
November 11, 1994

my

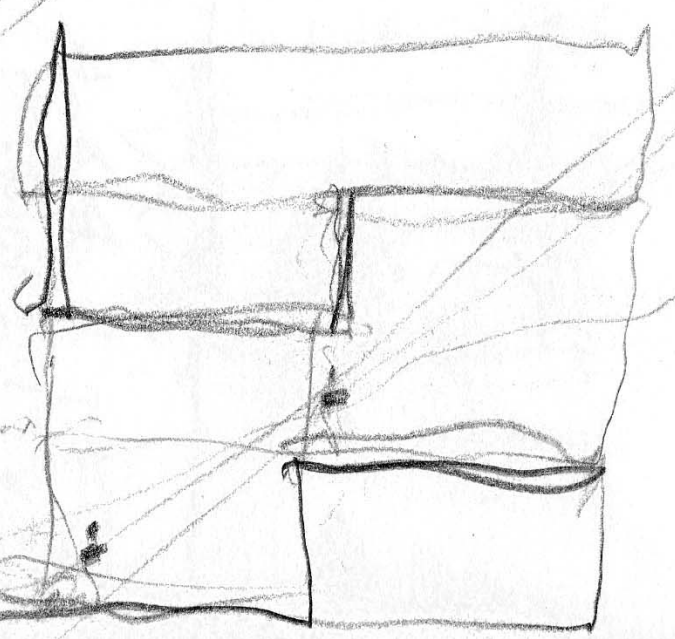

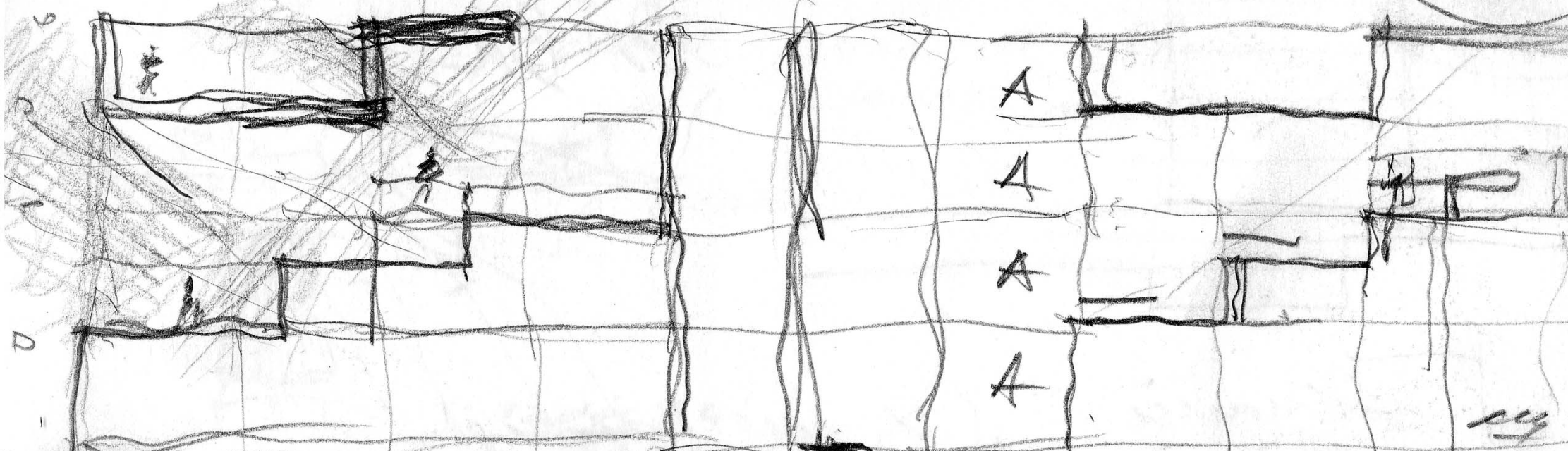

A A A A A A

November 11 94

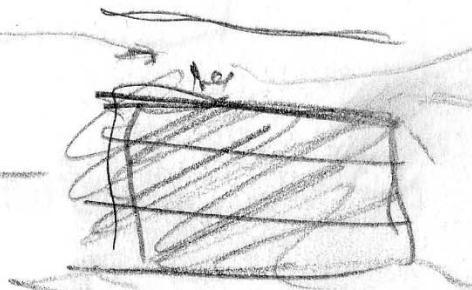
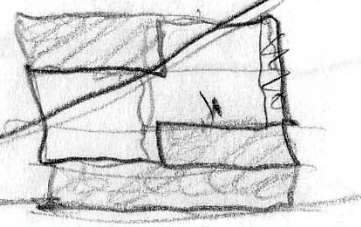
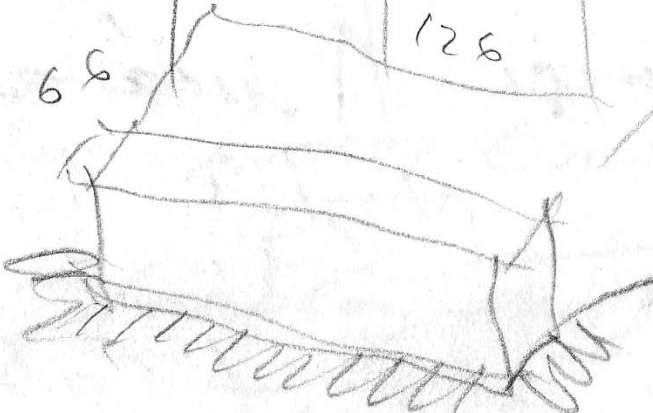

126
 1715
 630
 882
 126

16 x 8 = 128
 18 x 7 = 126

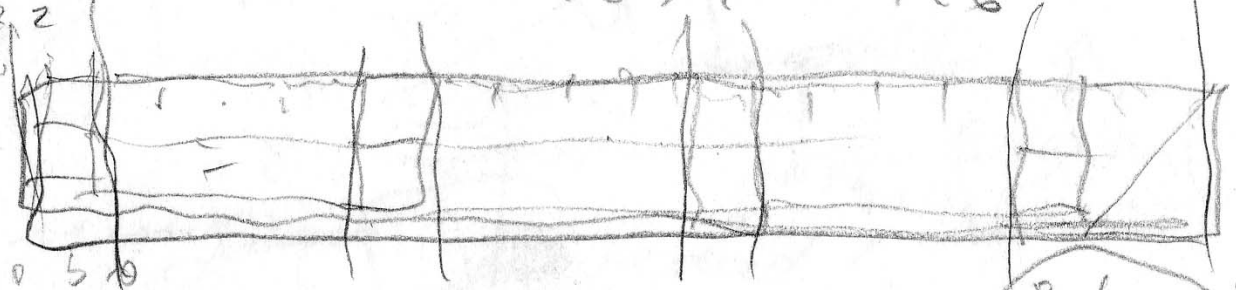
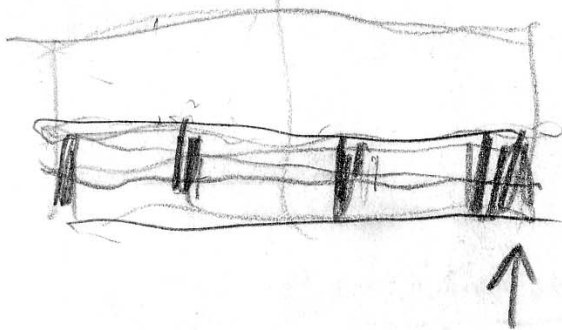

22050
 2205

9000 + 2000

8 | 20
 4 | 35
 8 | 7

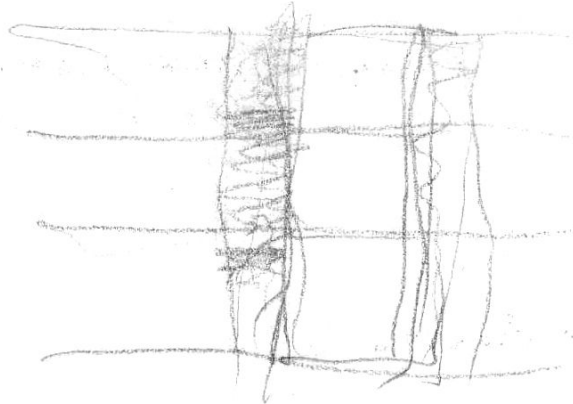

> tras leer el nuevo las bases en el
fren de 23 dice 99

- > Alvaro Siza / > Javier B° SOLERA
- > Juan NB / > Eduardo SOUTO
- > Julio CANO / >

> maquete con ferrocemento

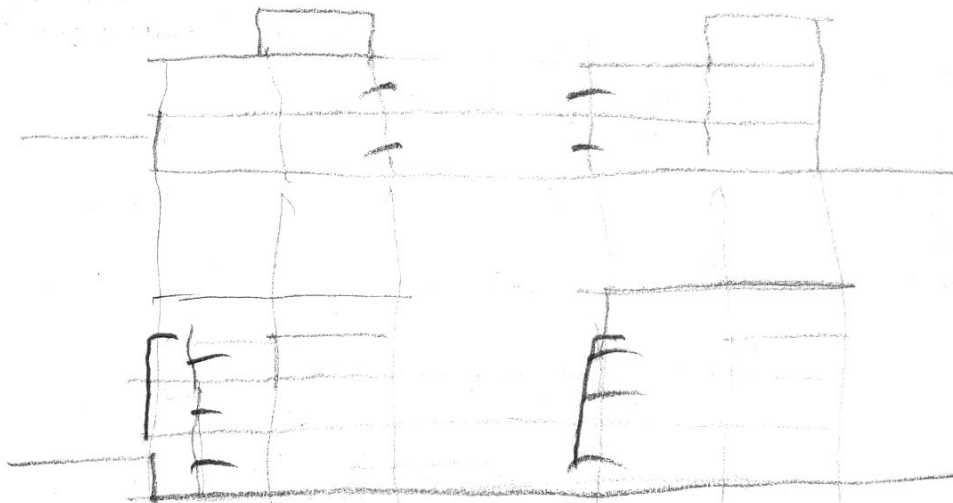
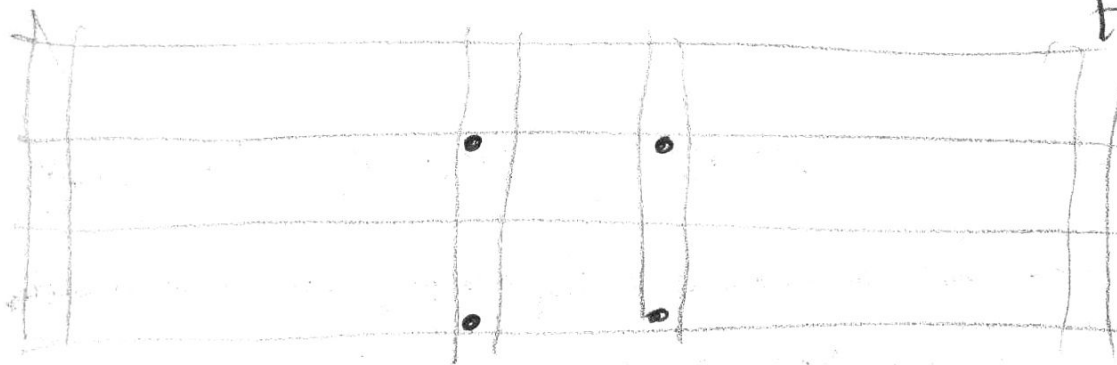
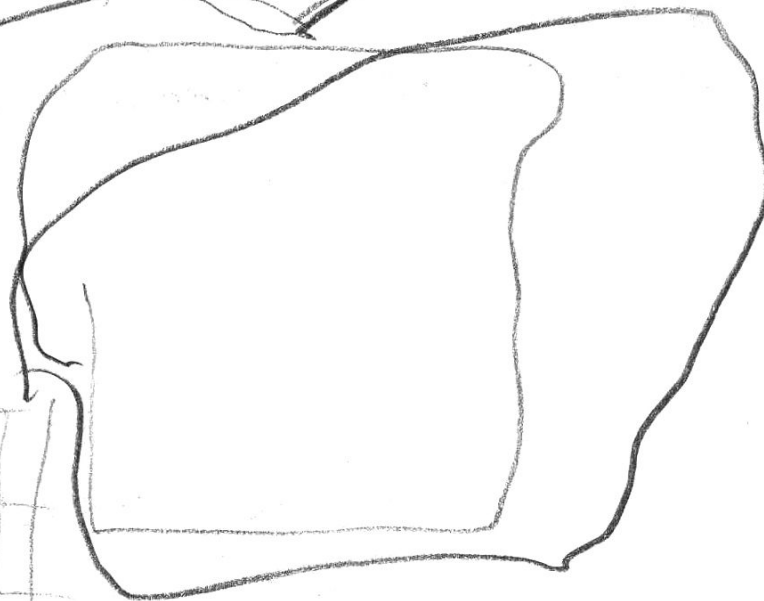
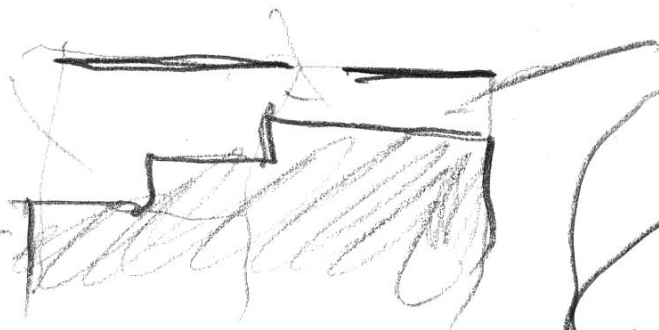
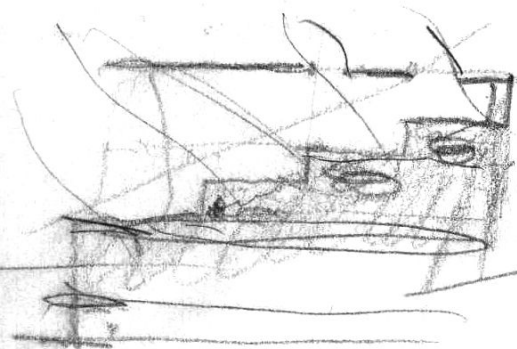
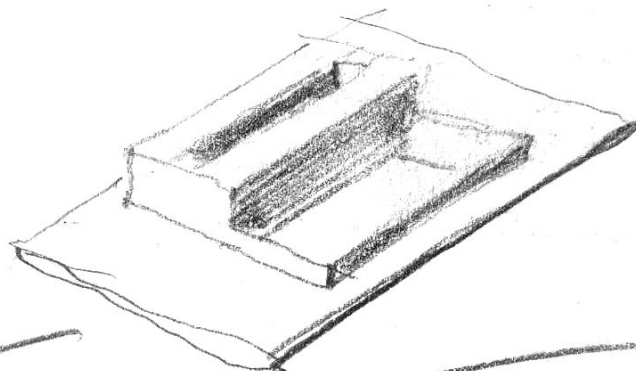

BIBA Caliz - December 29, 1961

533

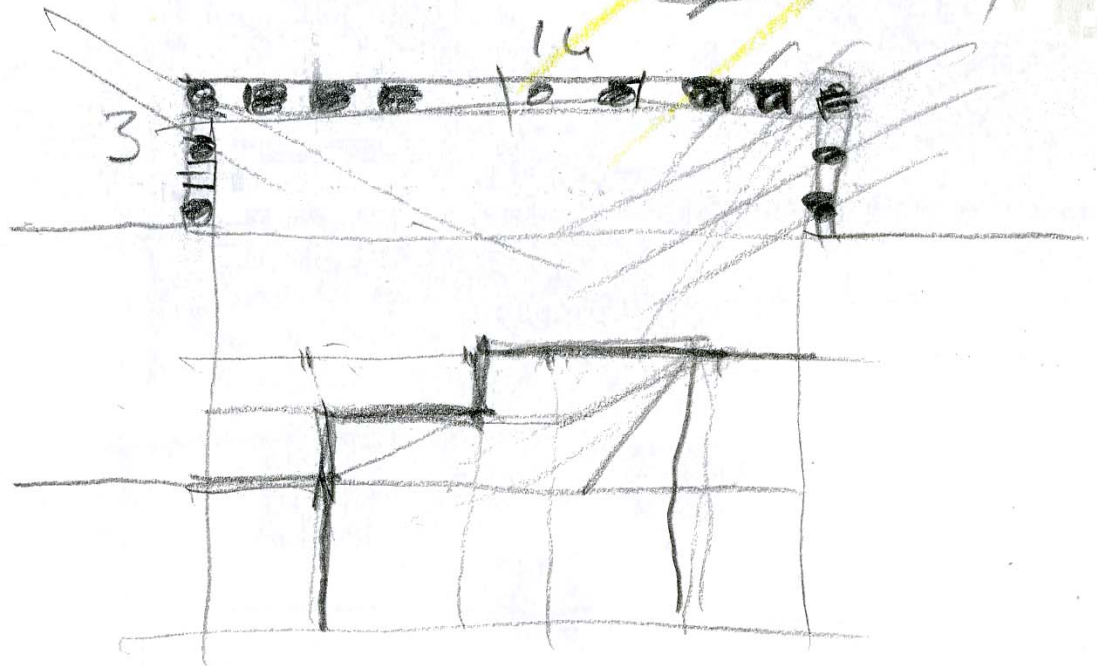
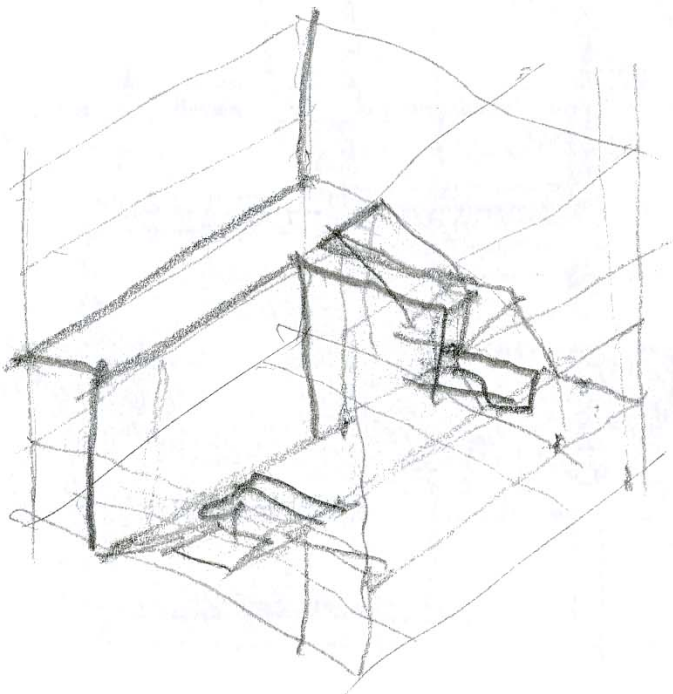
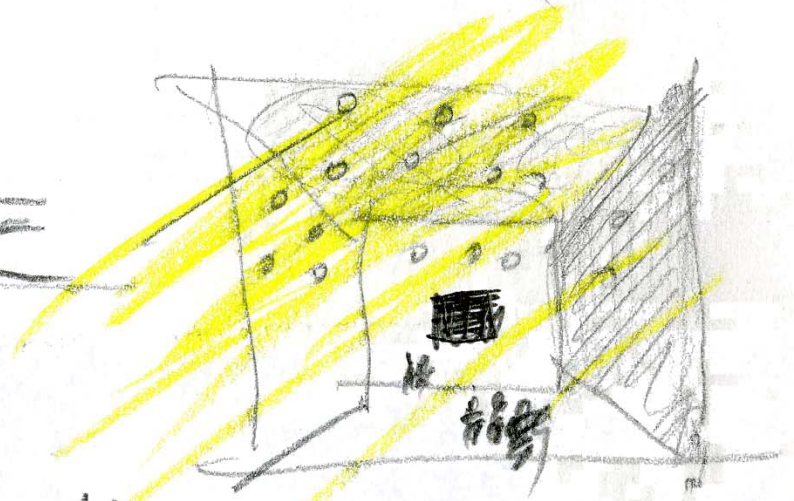
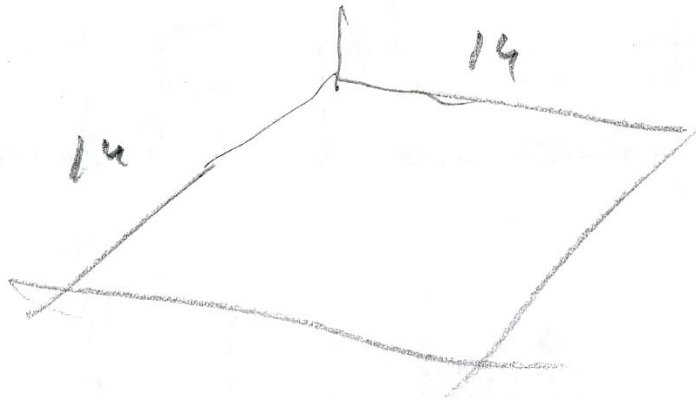
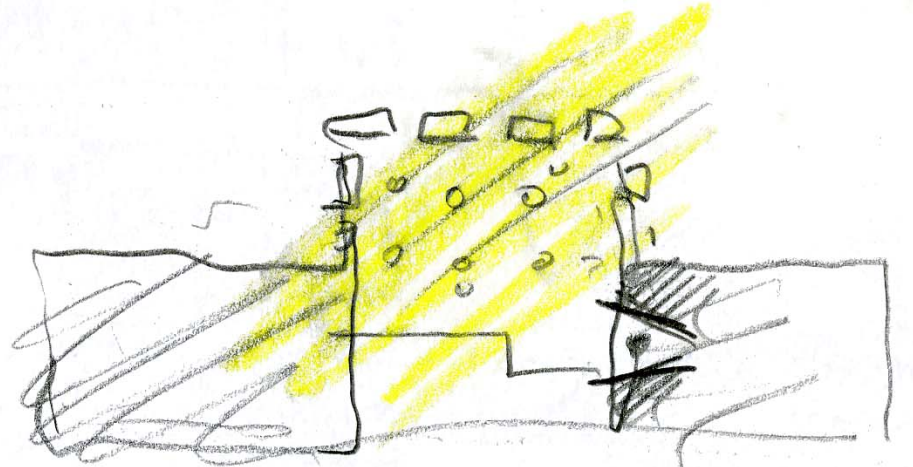
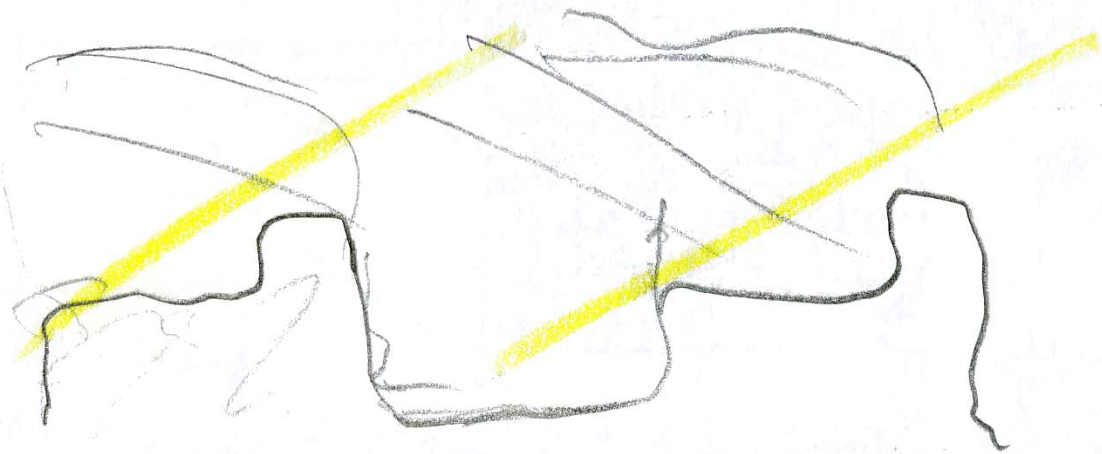

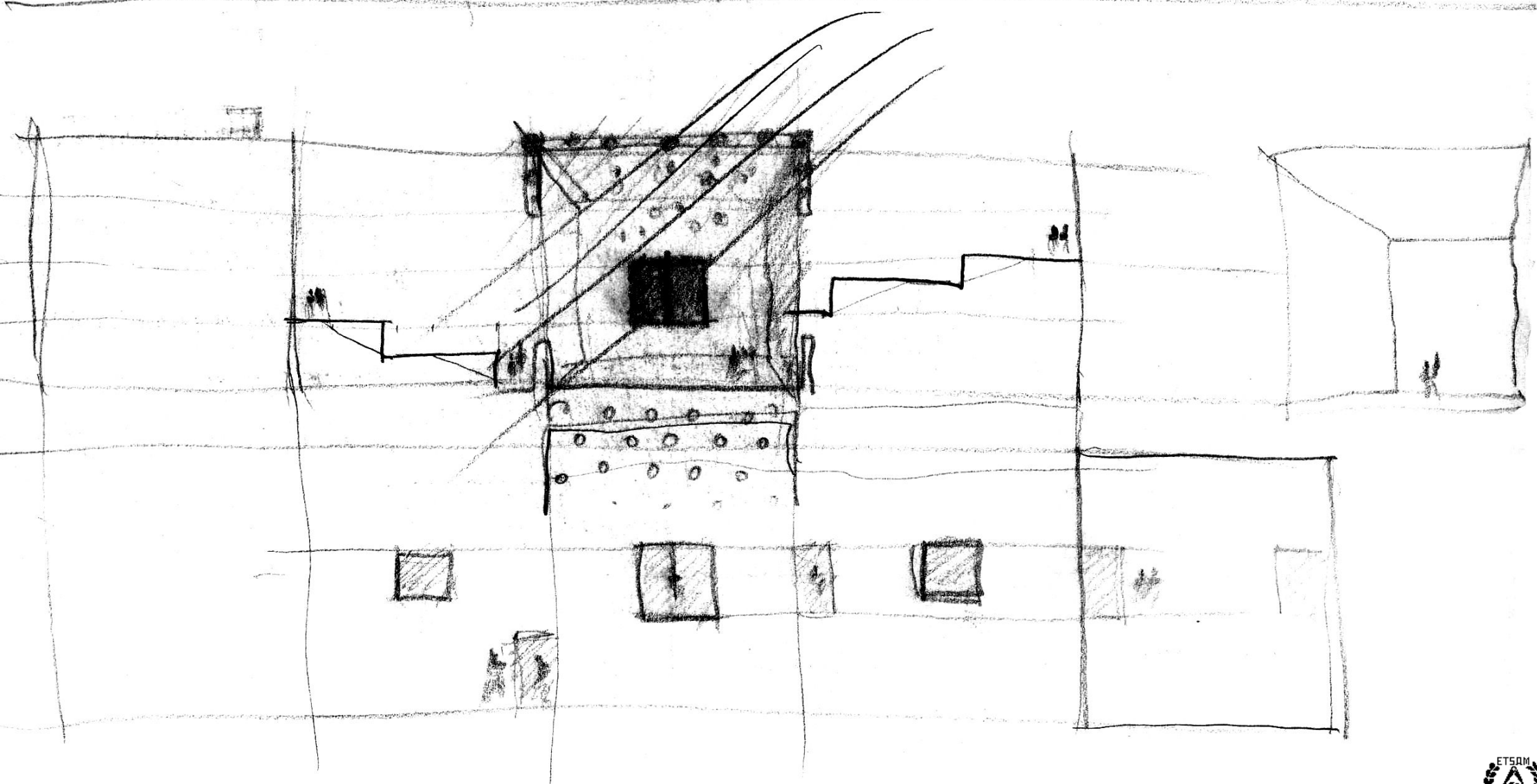
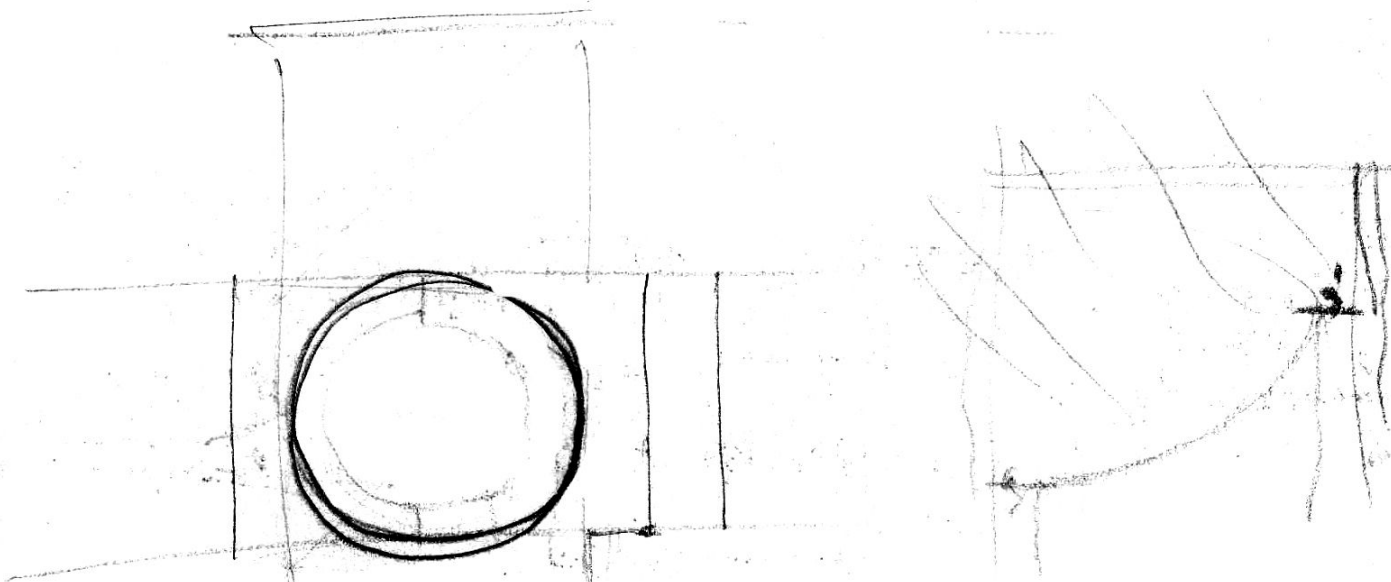

35

35

200

35

35

5

1 | 2 | 3 | 4 | 5

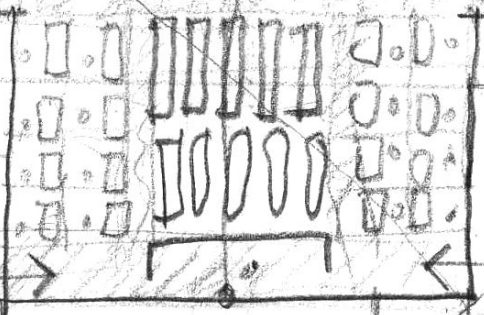

340 m² + 70 (410)

centro de Referencia e Informaçõs.

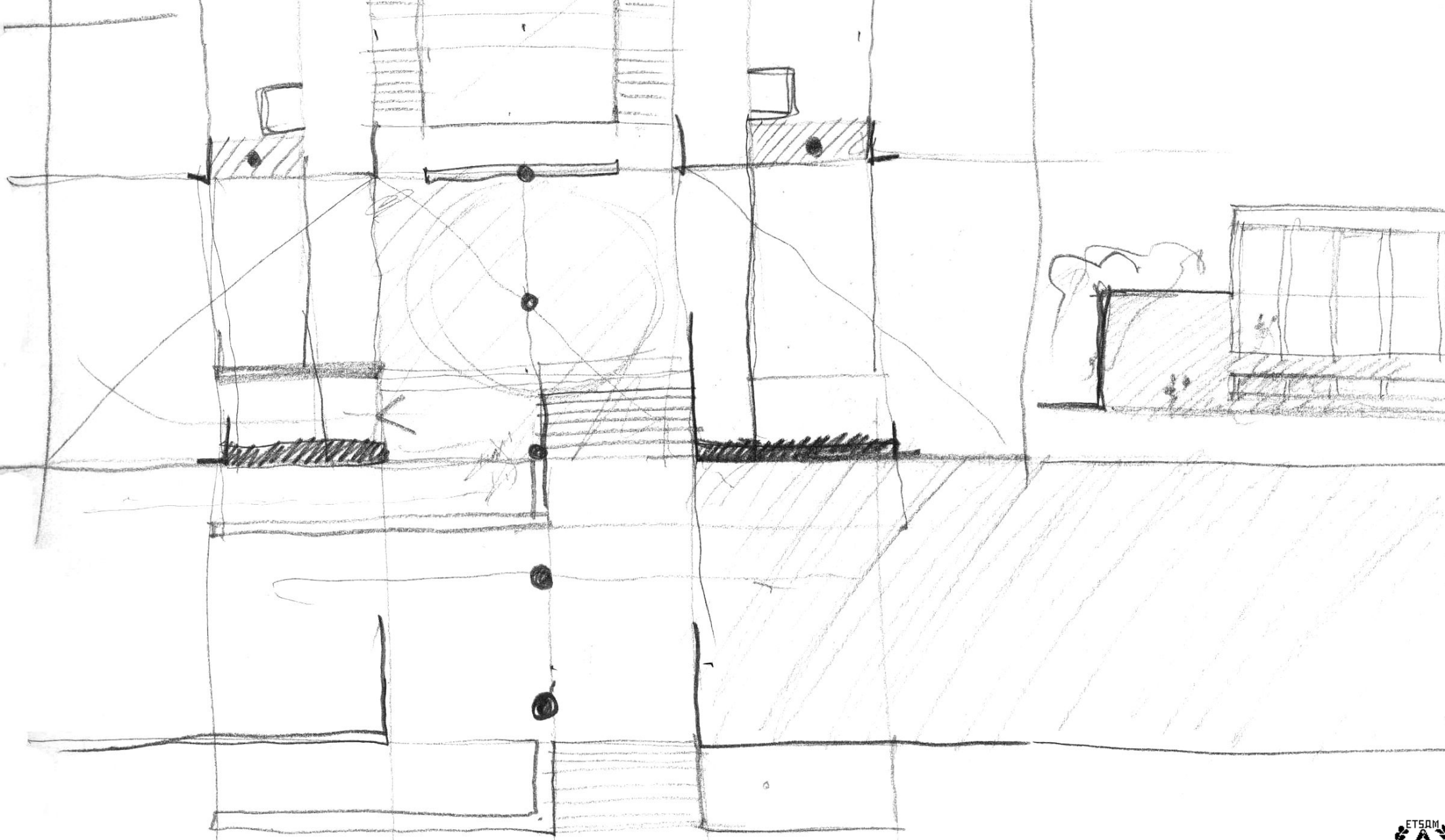

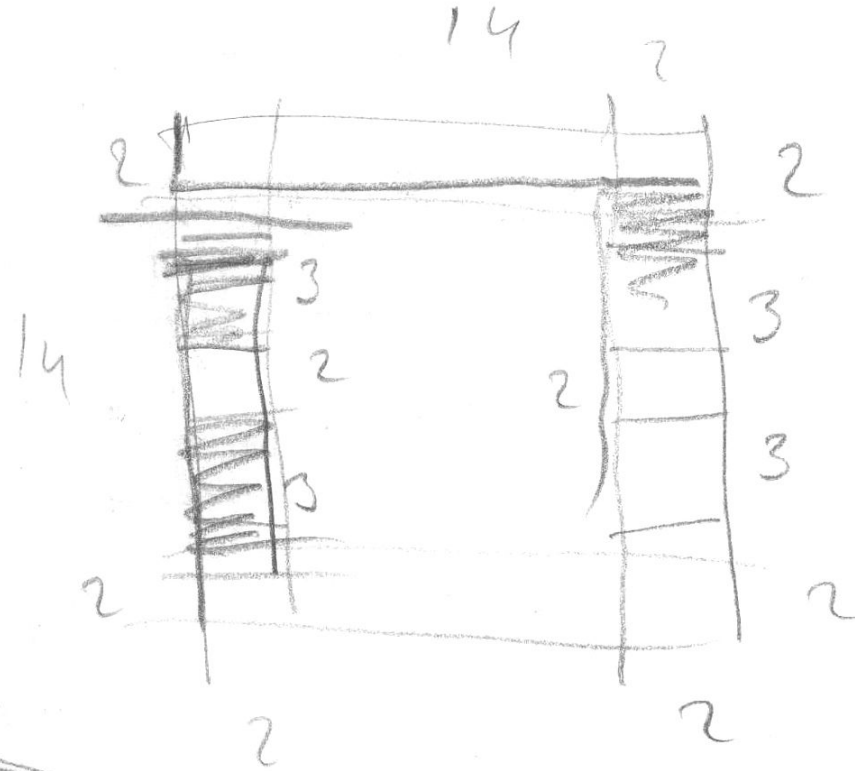
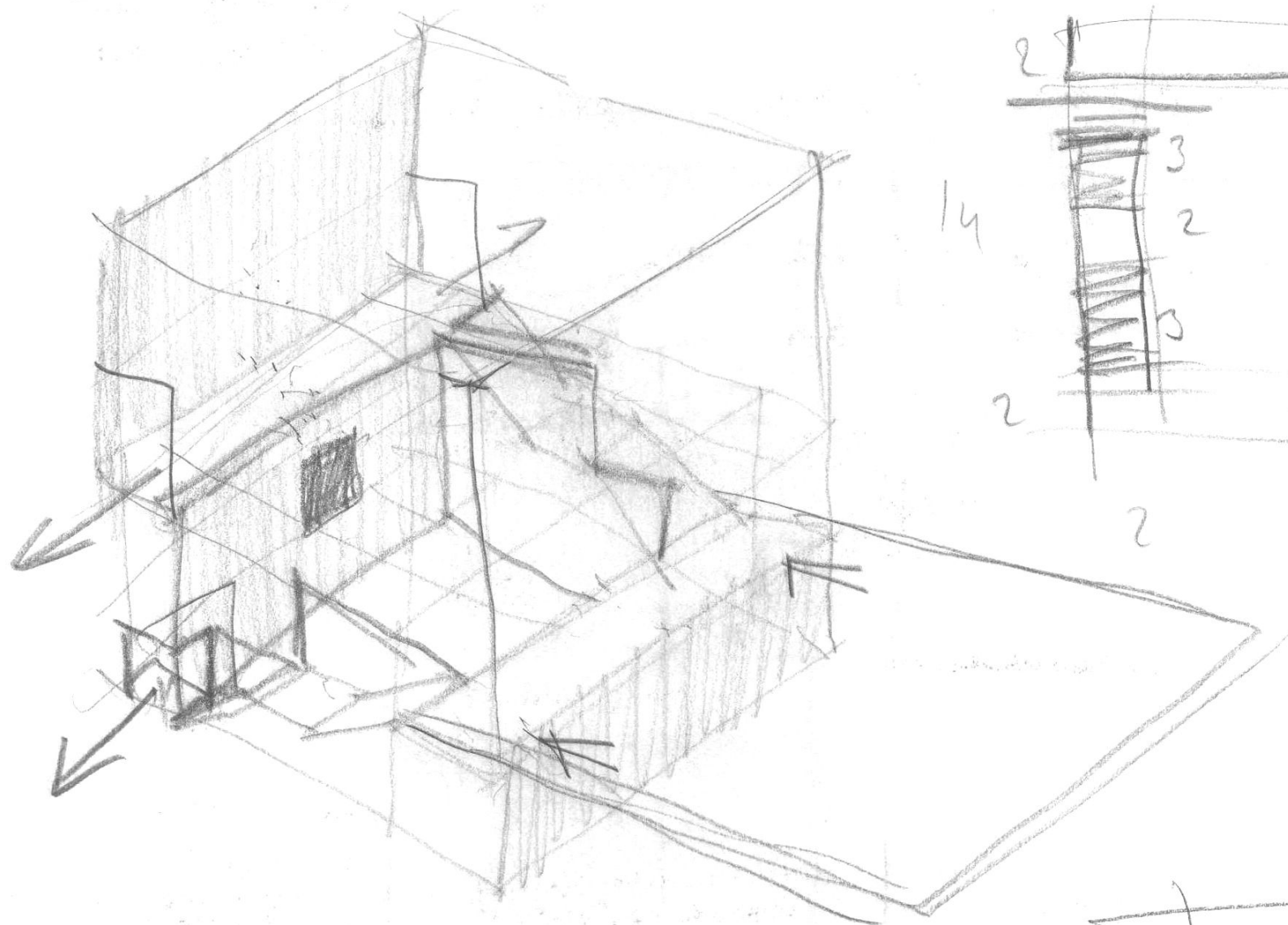

- 1 - Valencia - texto
- 2 - Book CJ - texto
- 3 - Tem Moull - info
- 4 - Ateneo Cádiz - texto
- 5 - cuento Teu - texto
- 6 - BIBA -

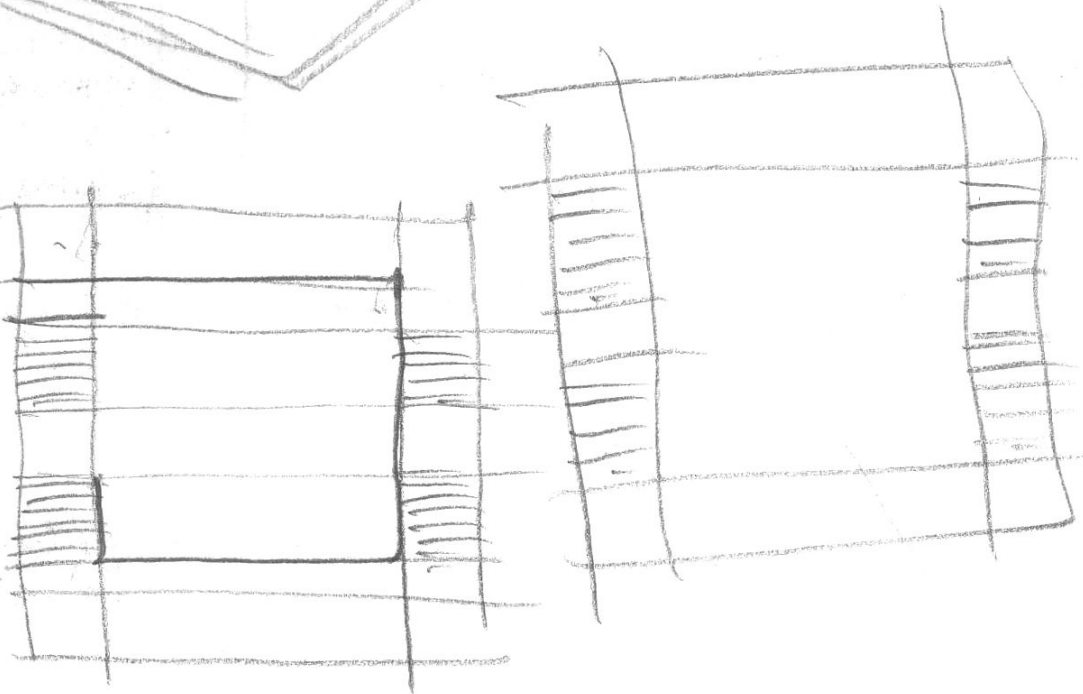

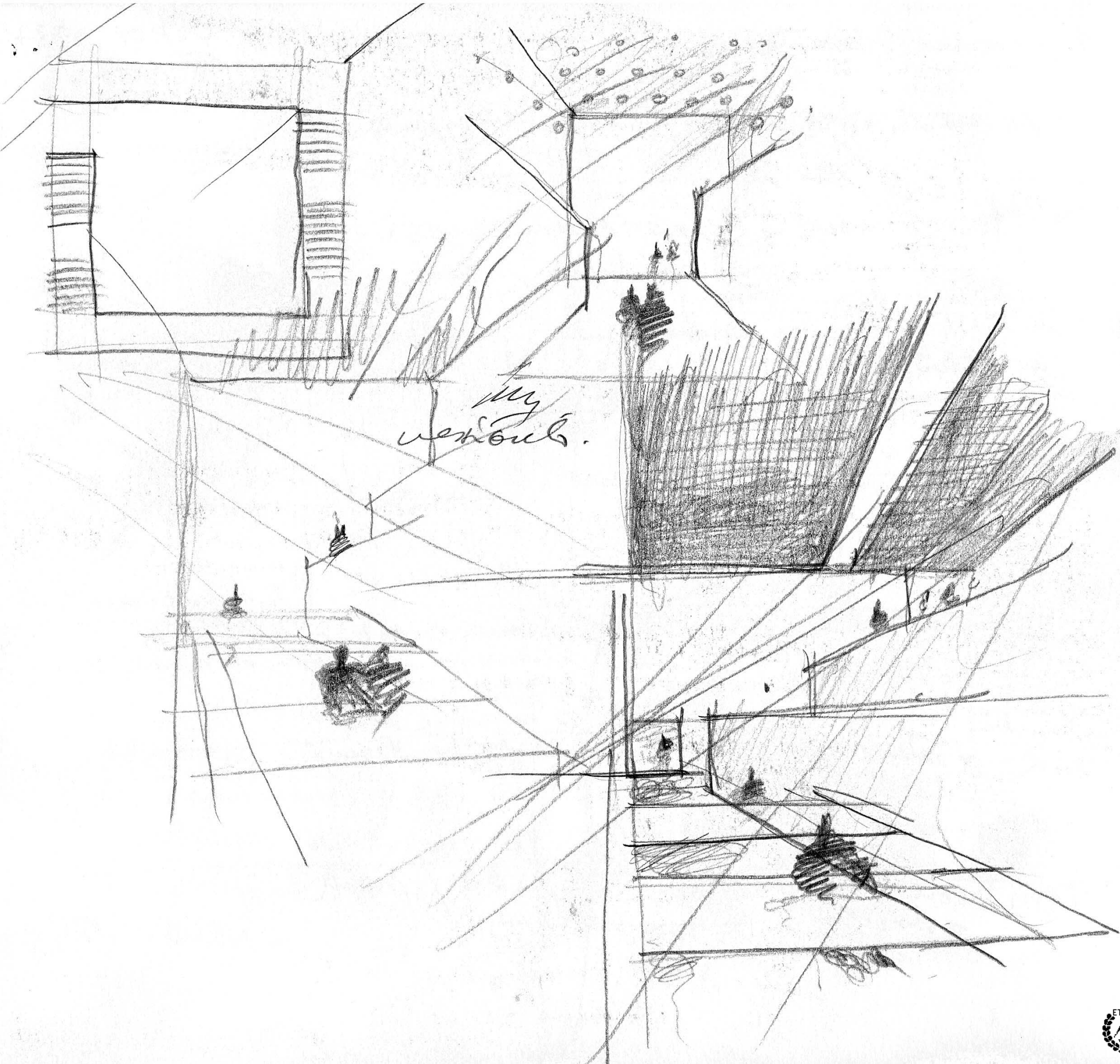

my version.

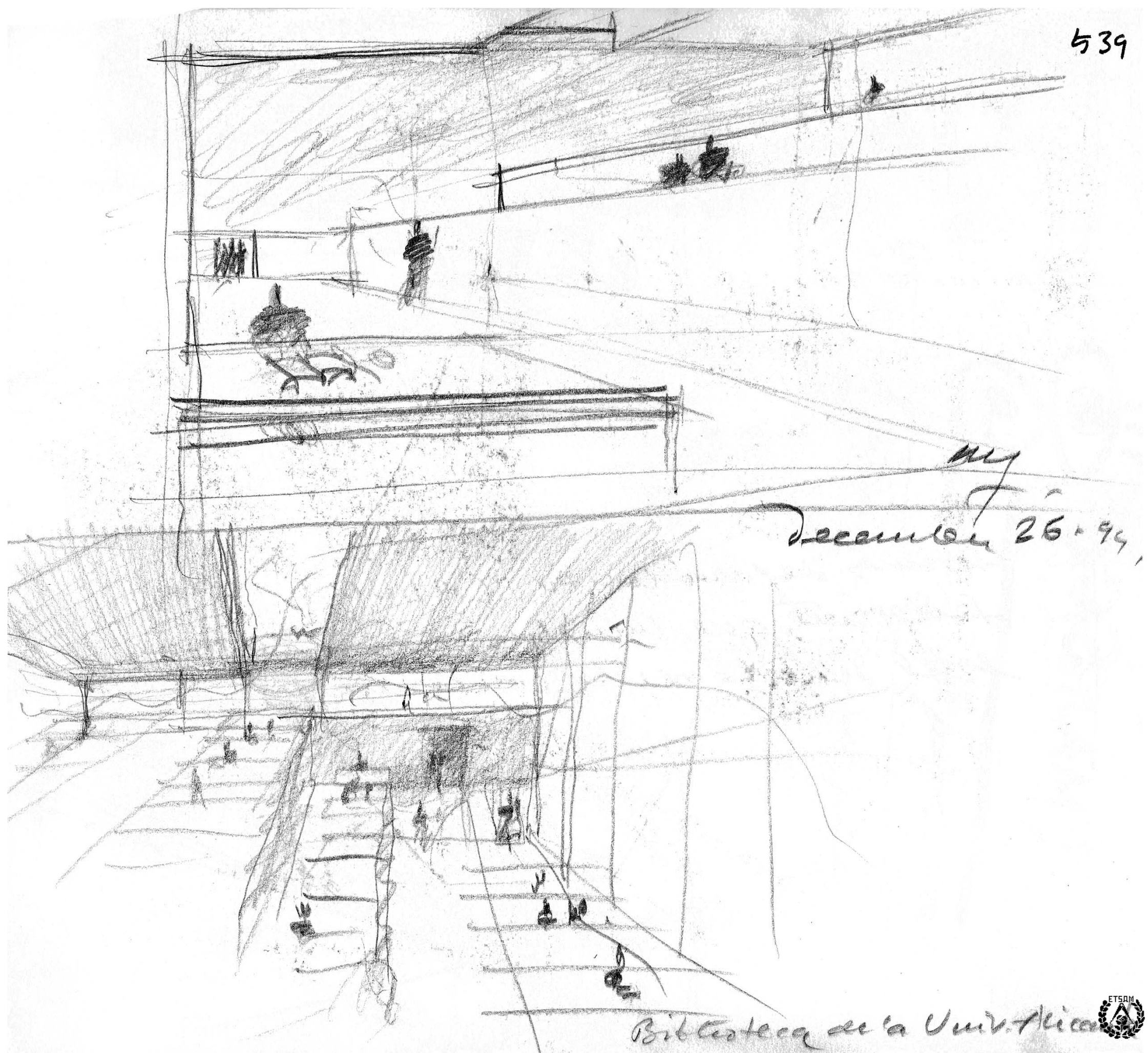

my
December 26, 94

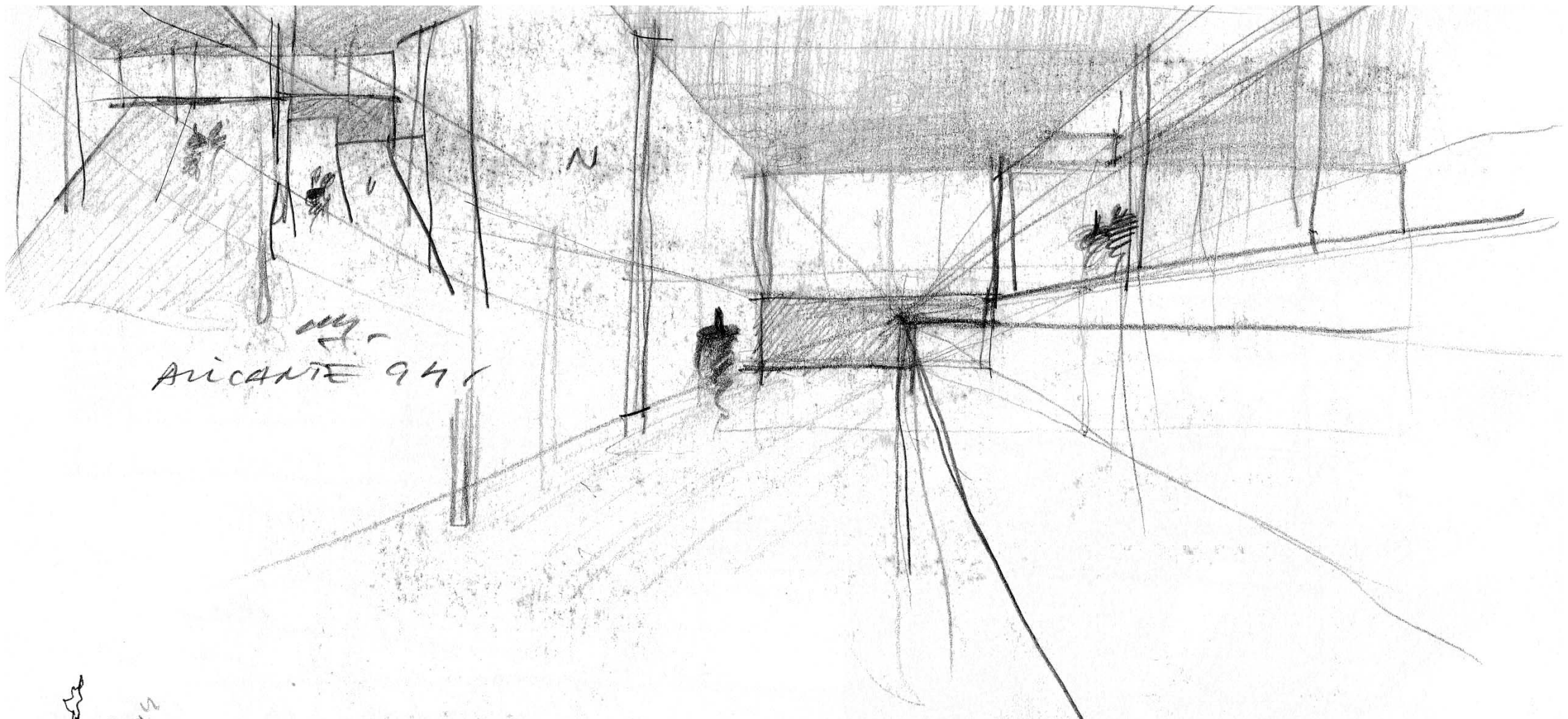

my.
Alicante 941

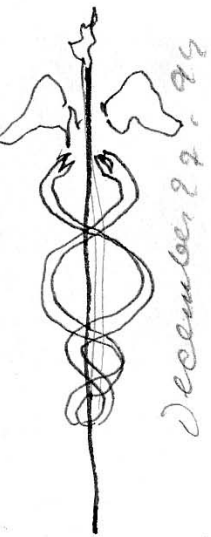

Hermes separó a los CADUCEDOS a los
serpientes que luchaban. Desde entonces
es el símbolo de la concordia.

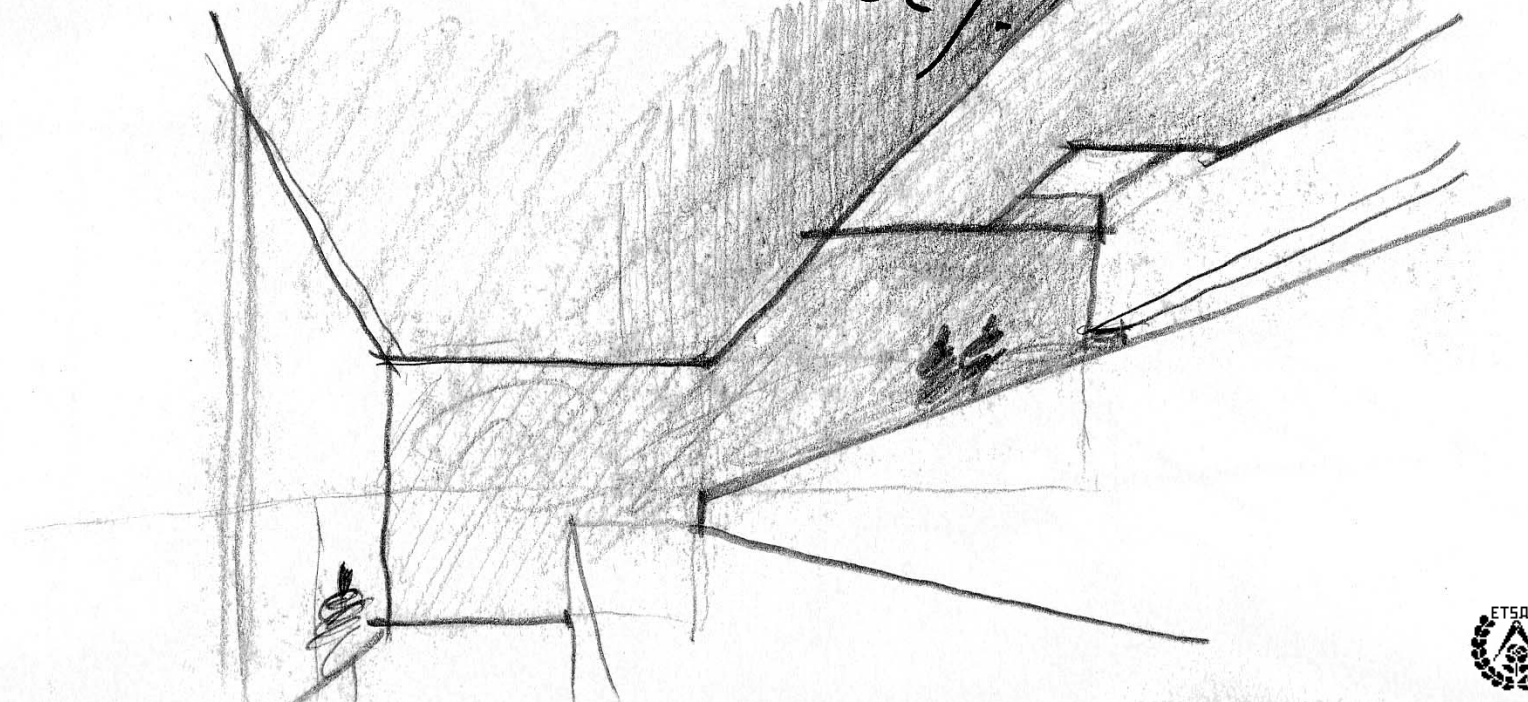

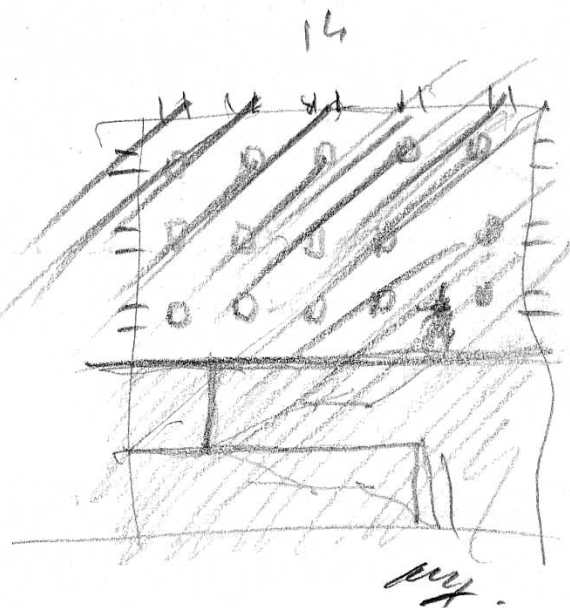

my.
January 6, 1995

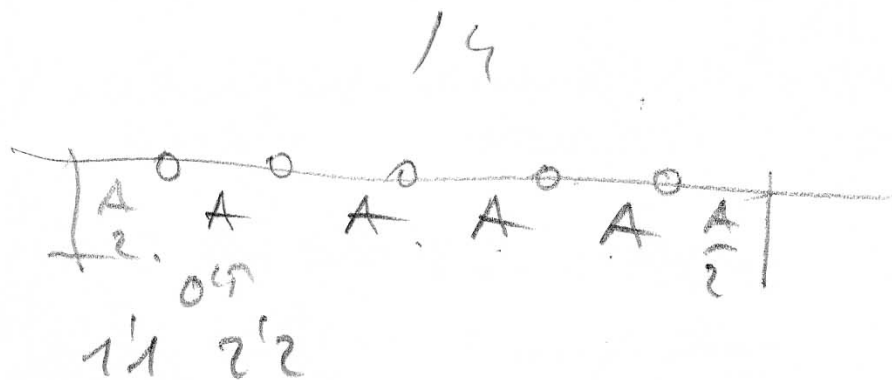
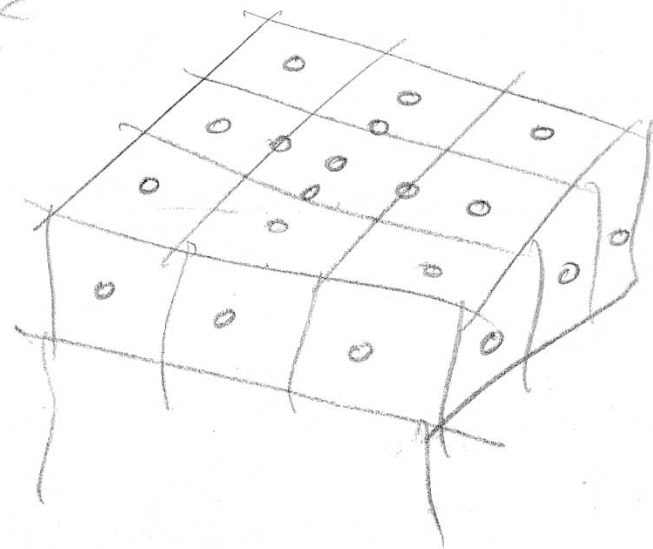
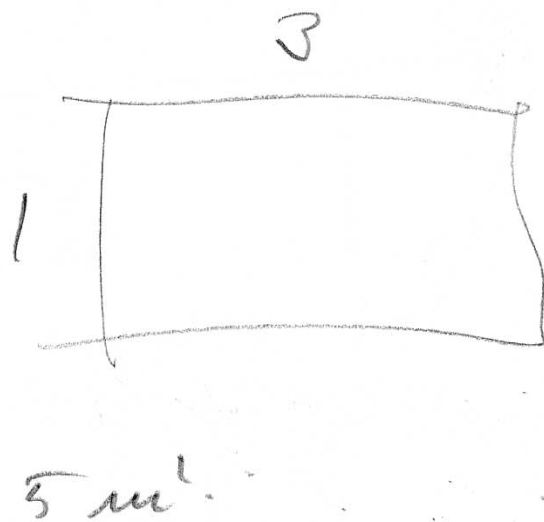
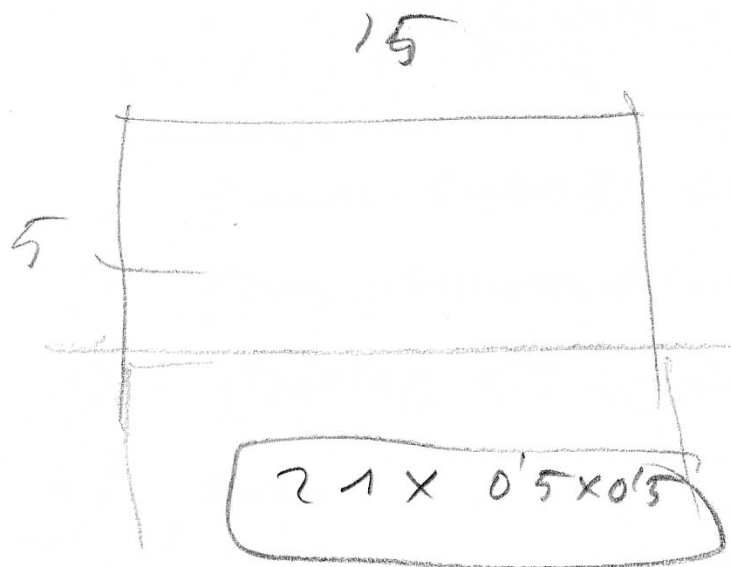
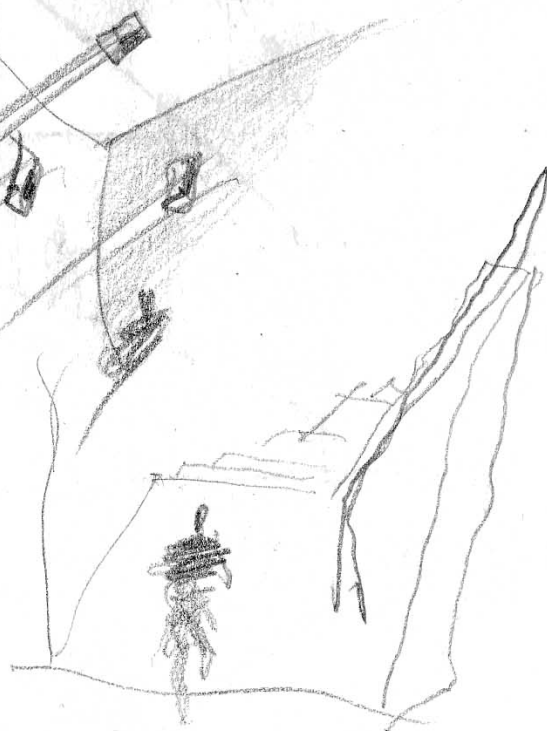

$$5A + 5 \times 0.5 = 13'5$$

2'5

$$A = \frac{11}{5} \quad 2'2$$

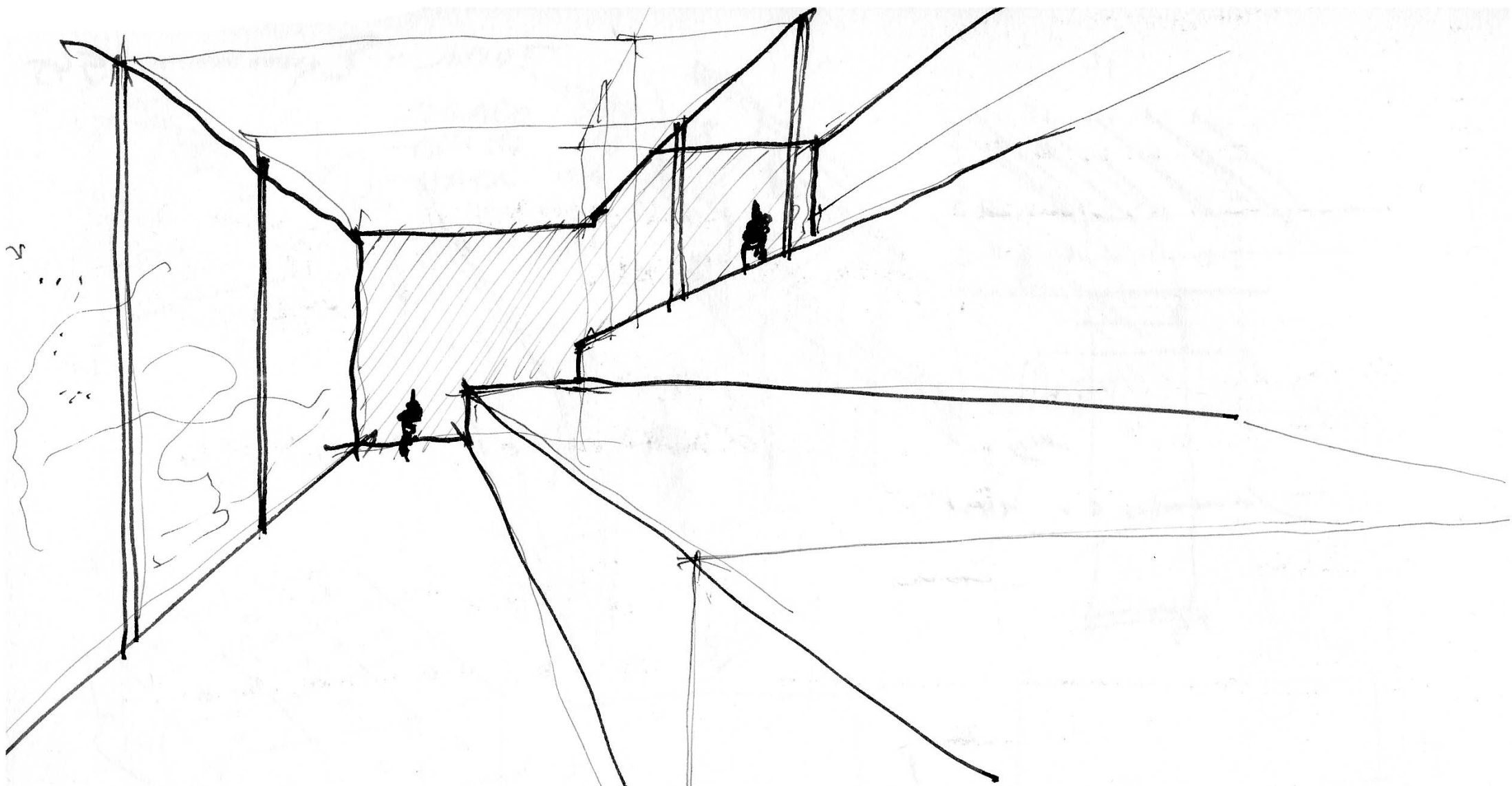

Biblioteca
Alicante. May. Jan. 22, 95

VAL → MAD

Fabada 18 enero 95.

after Valencia

- 1) billetes de 100 de dinero
- 2) \$ a tra candida
- 3) 2 cejillas practicable

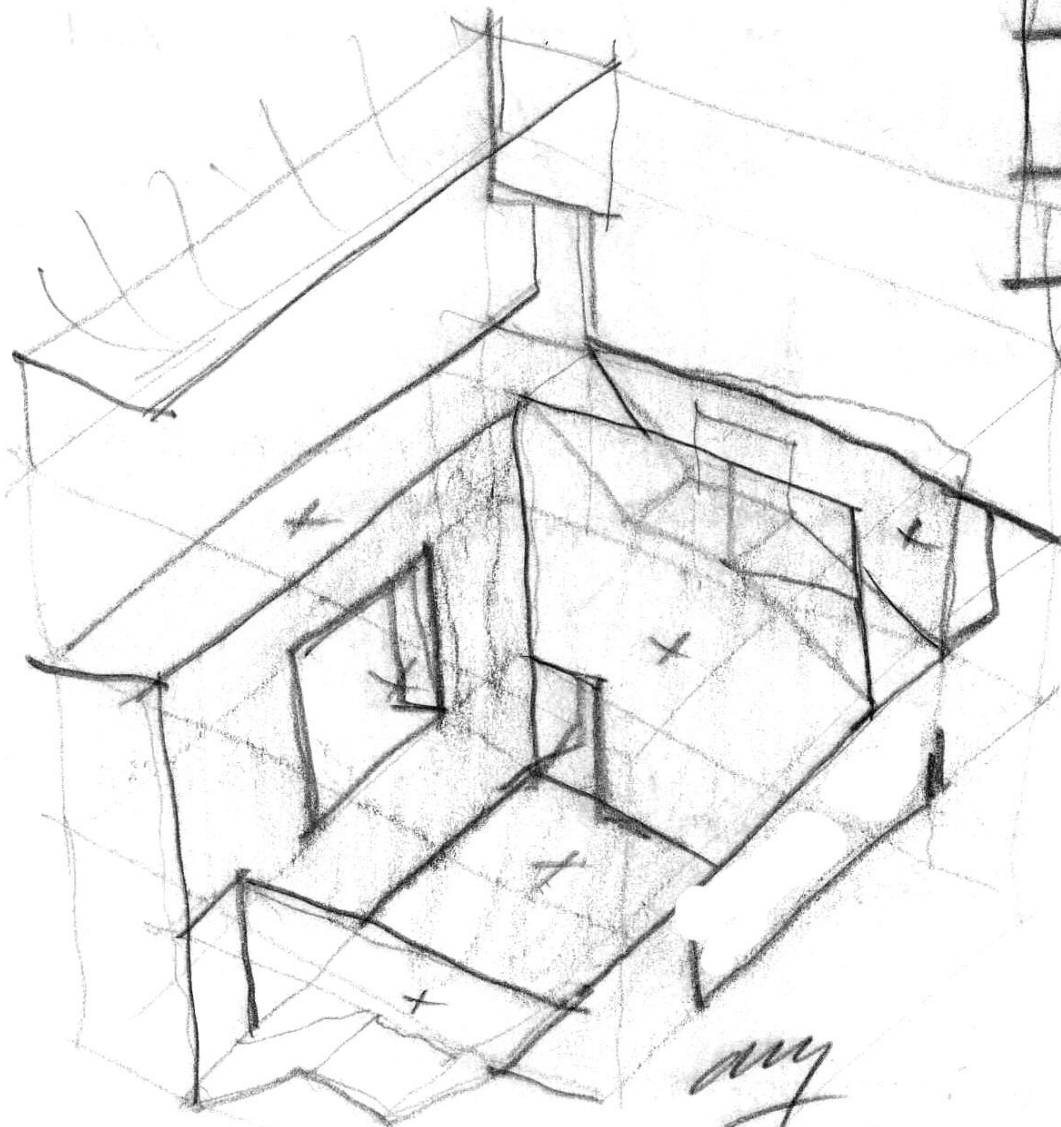

my

January 29, 95

la fivalda de sevilla junto a la Catedral
(ben acordada, ambar).

- > la sacristia de la Catedral de Granada
- > la cárcel Real de Cádiz es un bello edificio del
s XVIII levantado sobre un casco del XVII
- > distinción entre ANTIGUO-VIEJO MODERNO-BOB

LEGANÉS

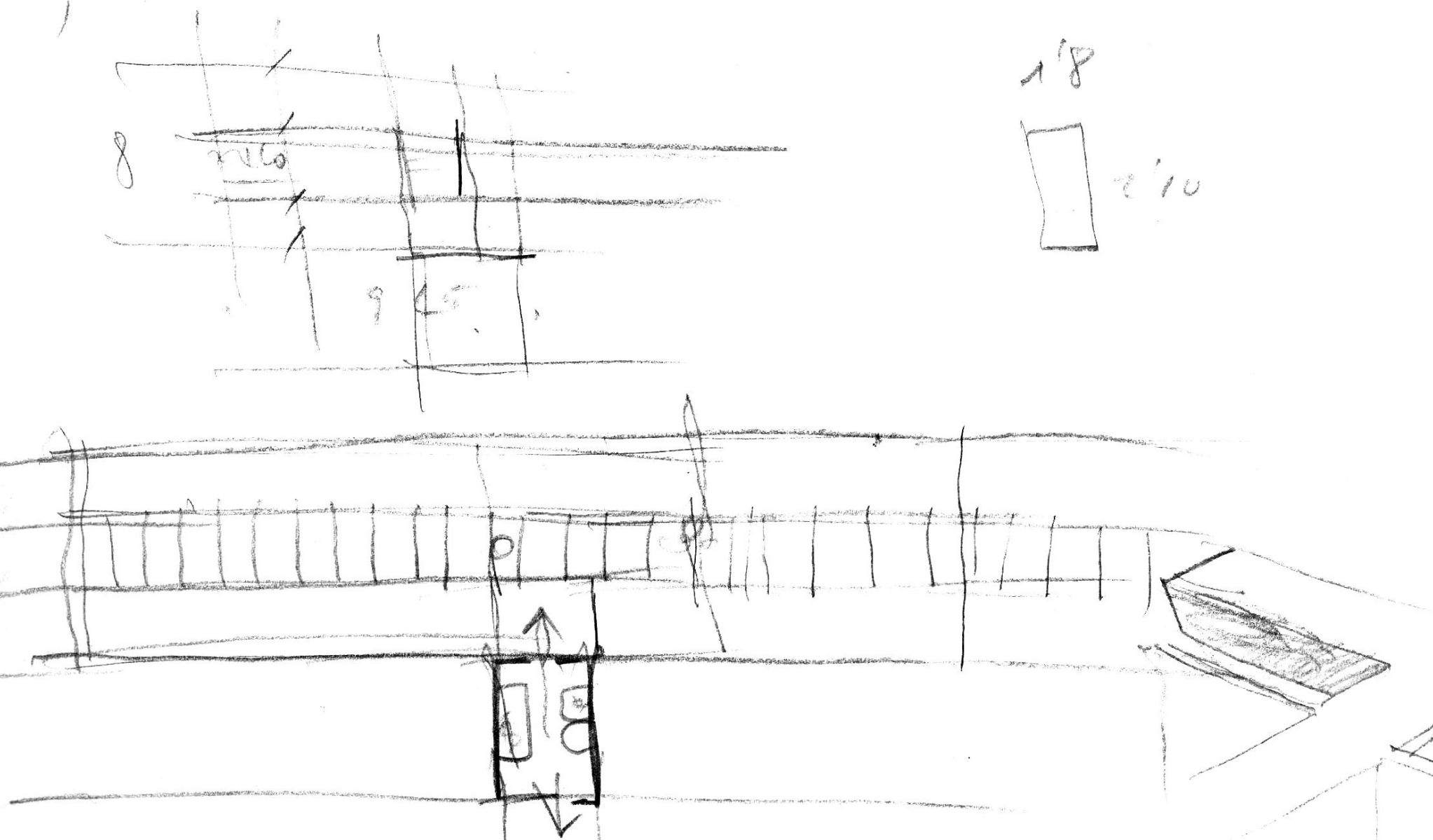

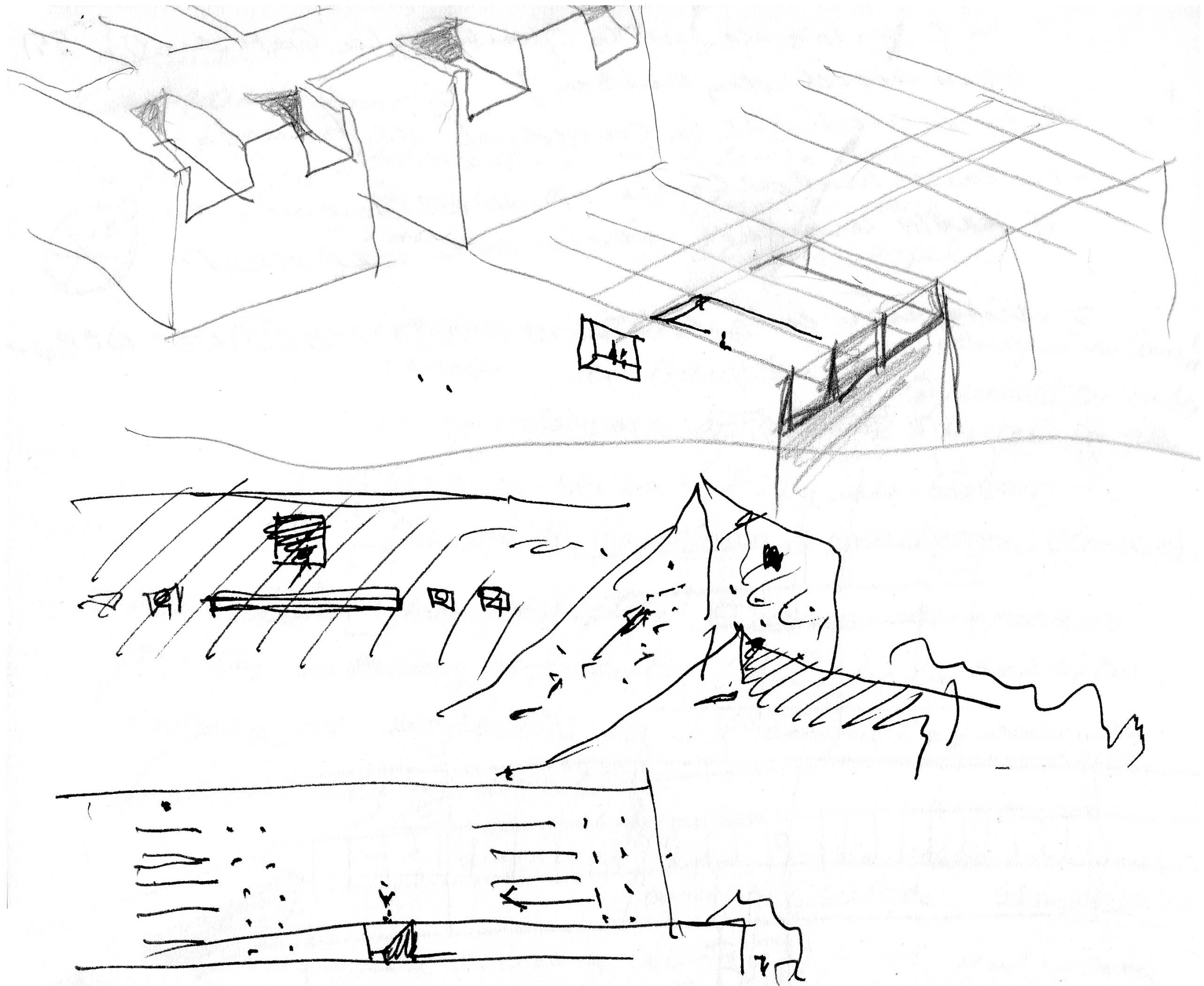

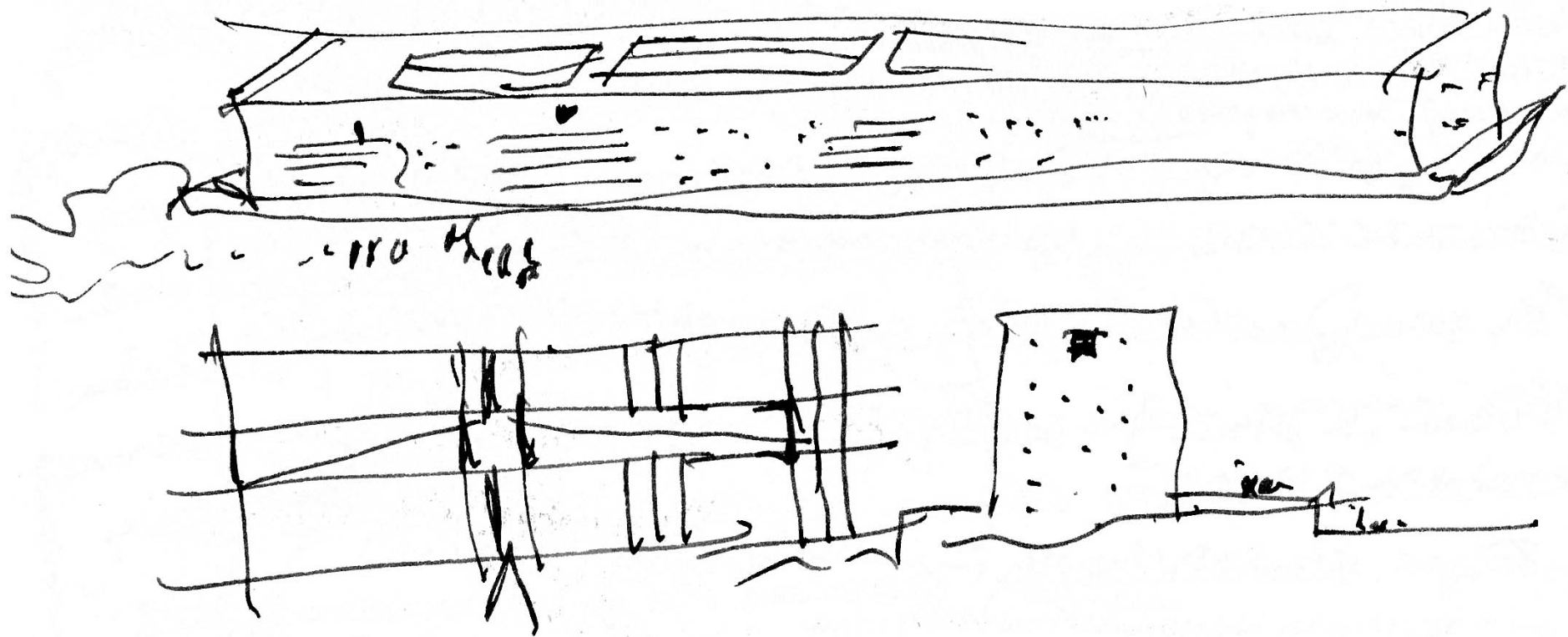

Argumento la Maura fraudine.

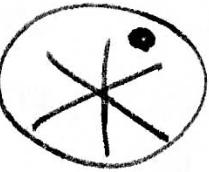

Me contaron que hubo una vez en Francia
 un arquitecto, que no era de Francia; ¡claro! al que
 se le había enseñado en que todas las fachadas,
 el francés fuera iguales, del mismo estilo.
 Nunca dije ni qué, pero del mismo estilo. Y como
 el estilo que le gustaba era el estilo "alcazar"
 (el pobre no sabía que se decía "arabes"), pues quien
 tiene todas que todas las fachadas de Francia
 fueran "arabes". Me contaron que propuso
 y no lo brama, el que se recibieran todas la

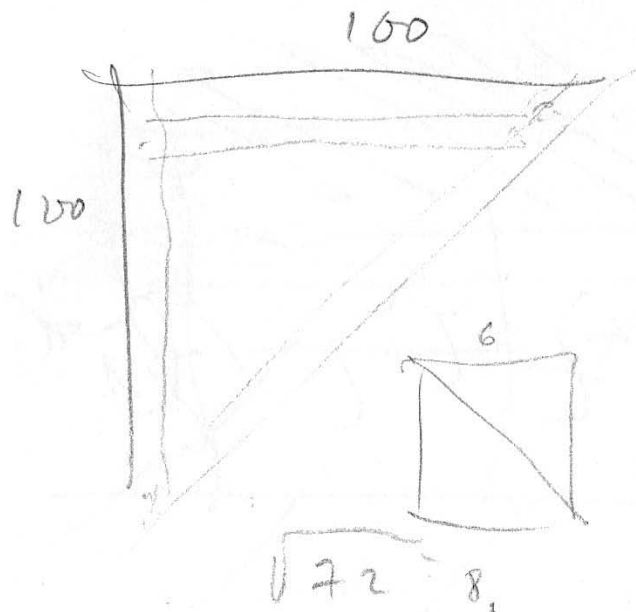

$$\begin{array}{r}
 88 \\
 88 \\
 \hline
 776 \times 6 \\
 + 125 \times 8.5 \\
 525 \\
 1000 \\
 \hline
 10625
 \end{array}$$

1000

1056

may 15. 1995 "Giardino torpelo"

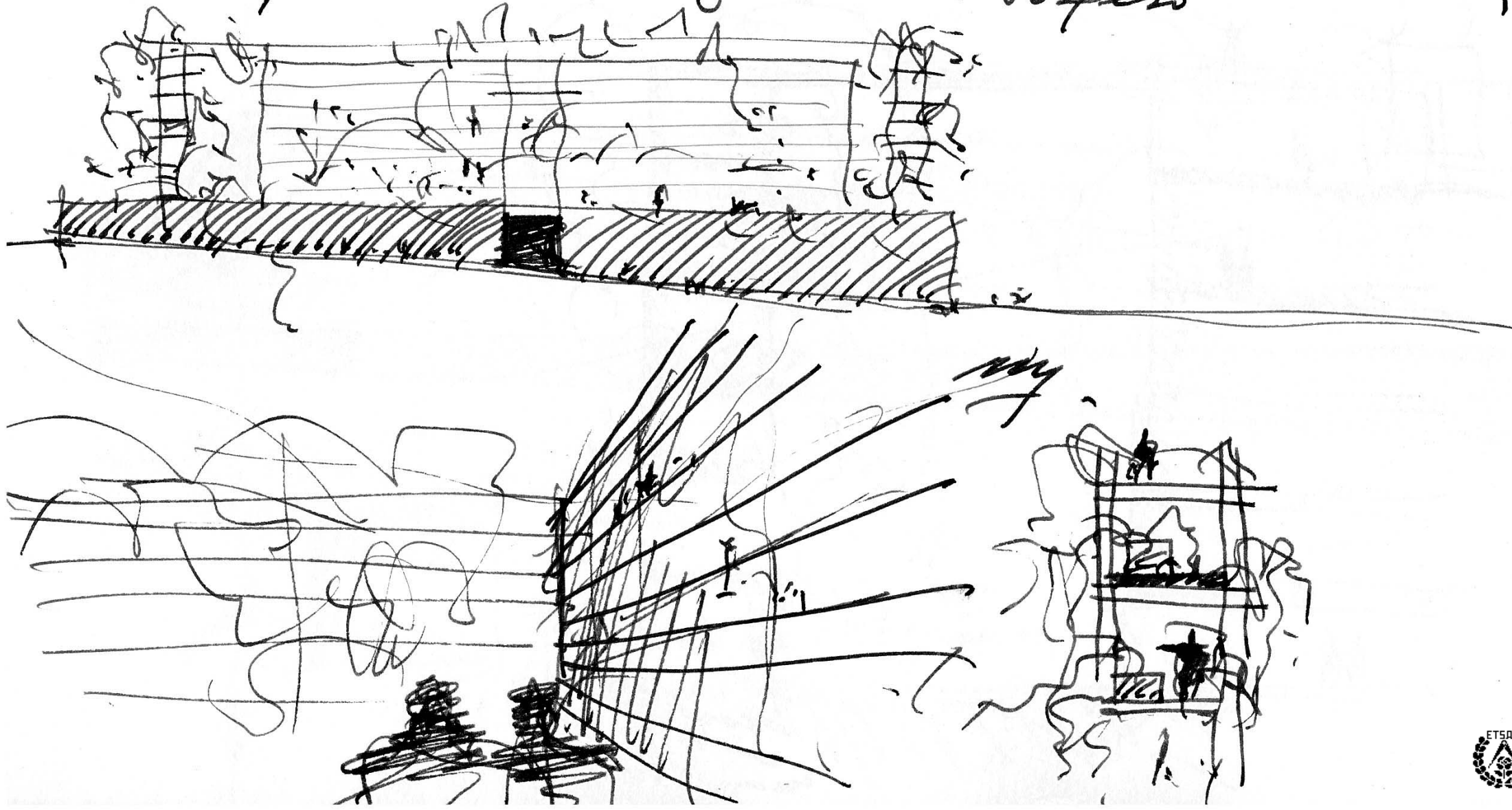



my
may 16. 95

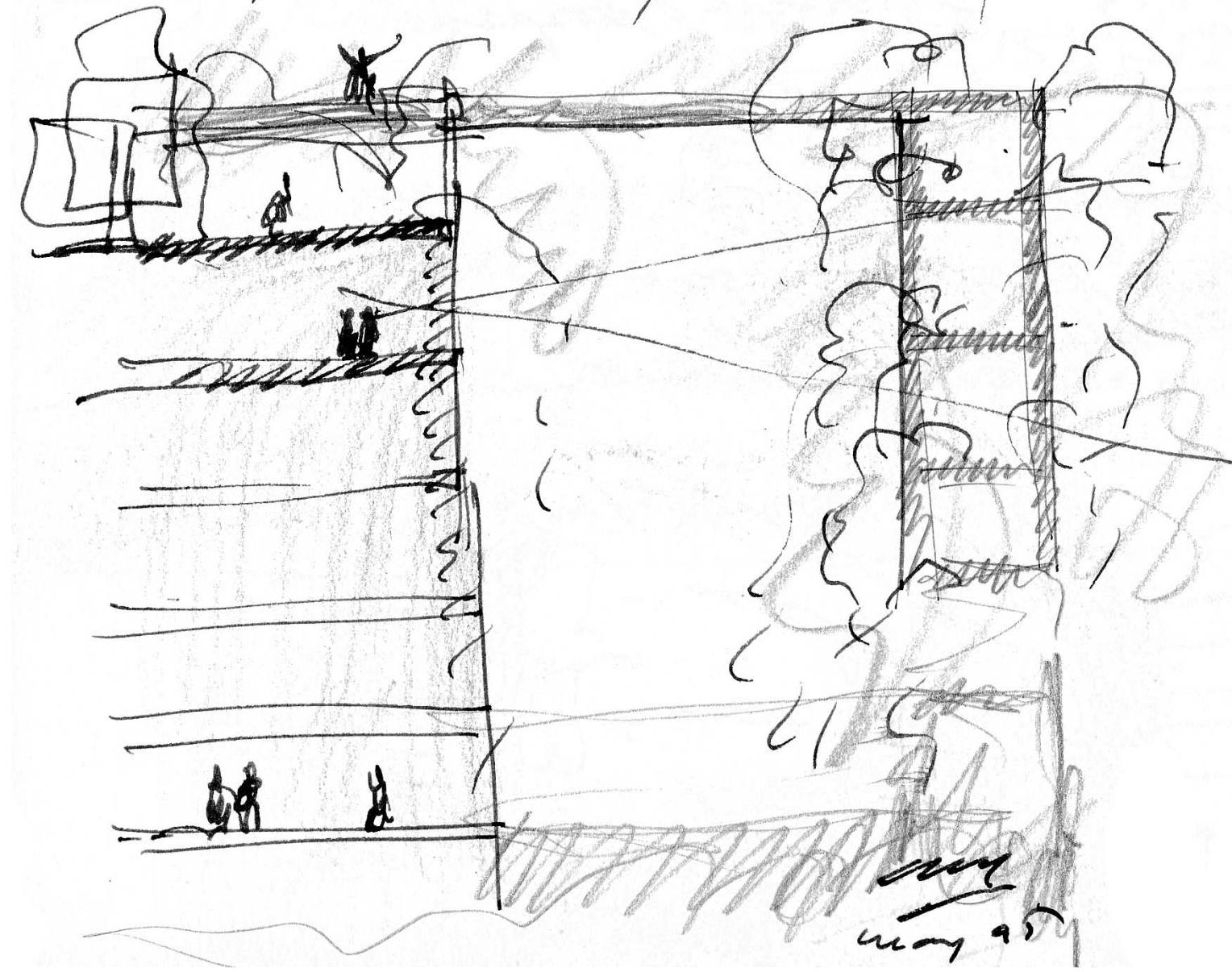

my
may 95

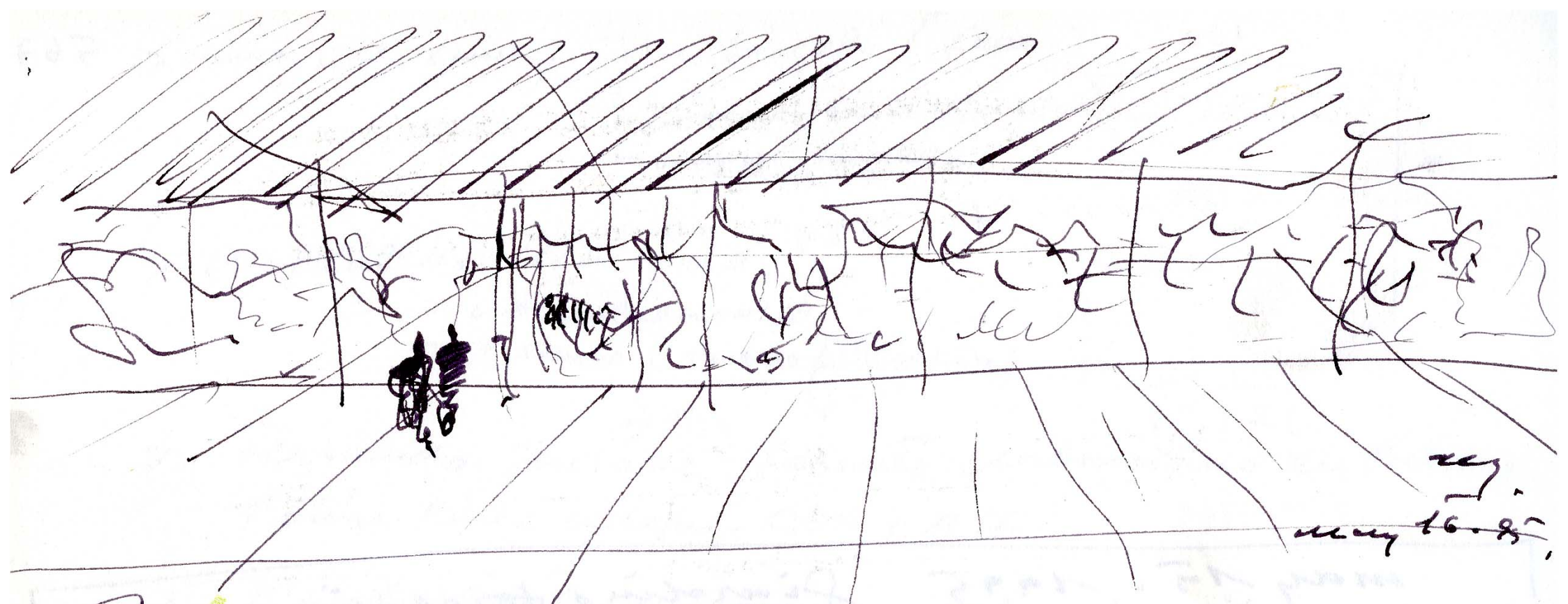

my
May 16. 95

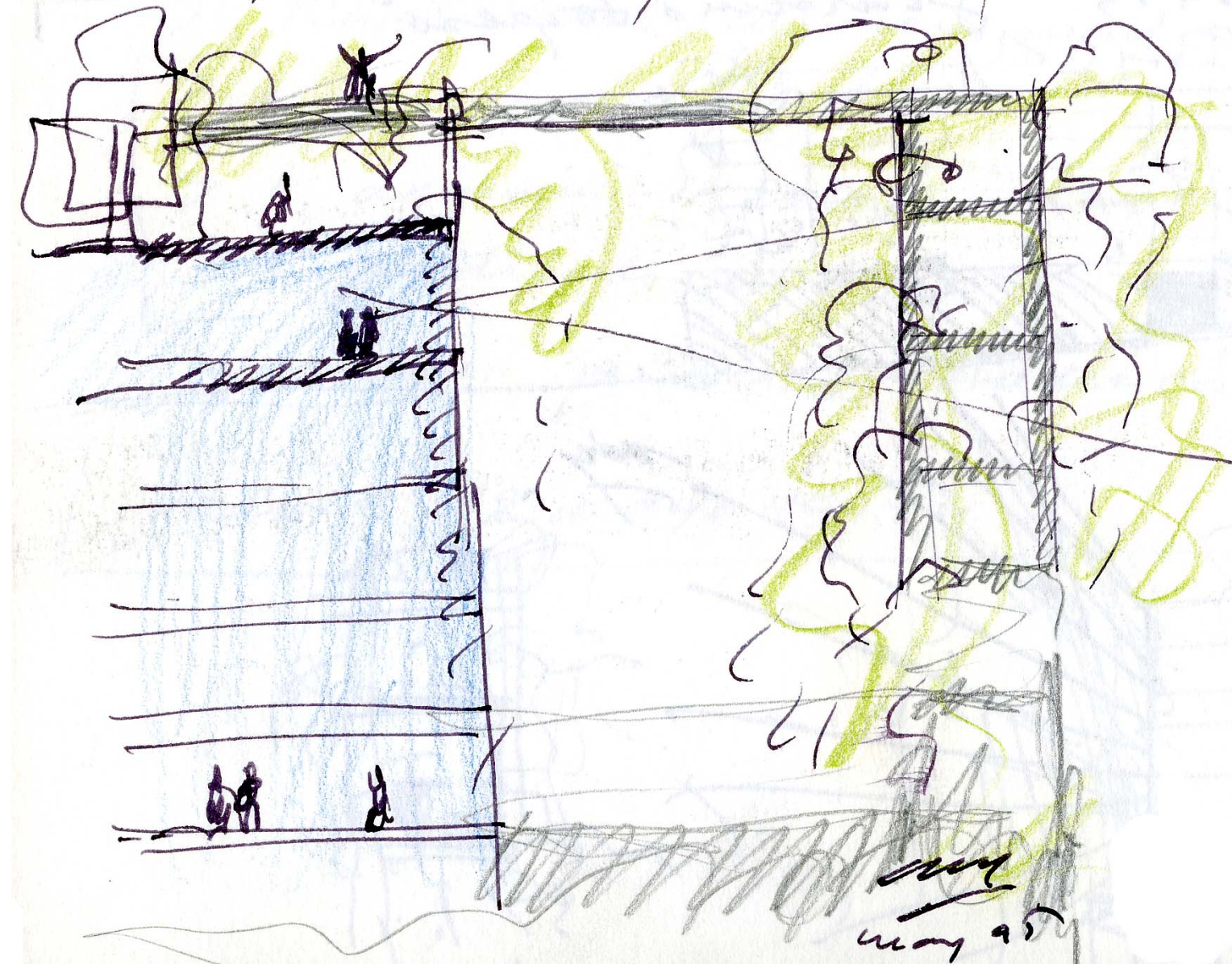

my
May 95

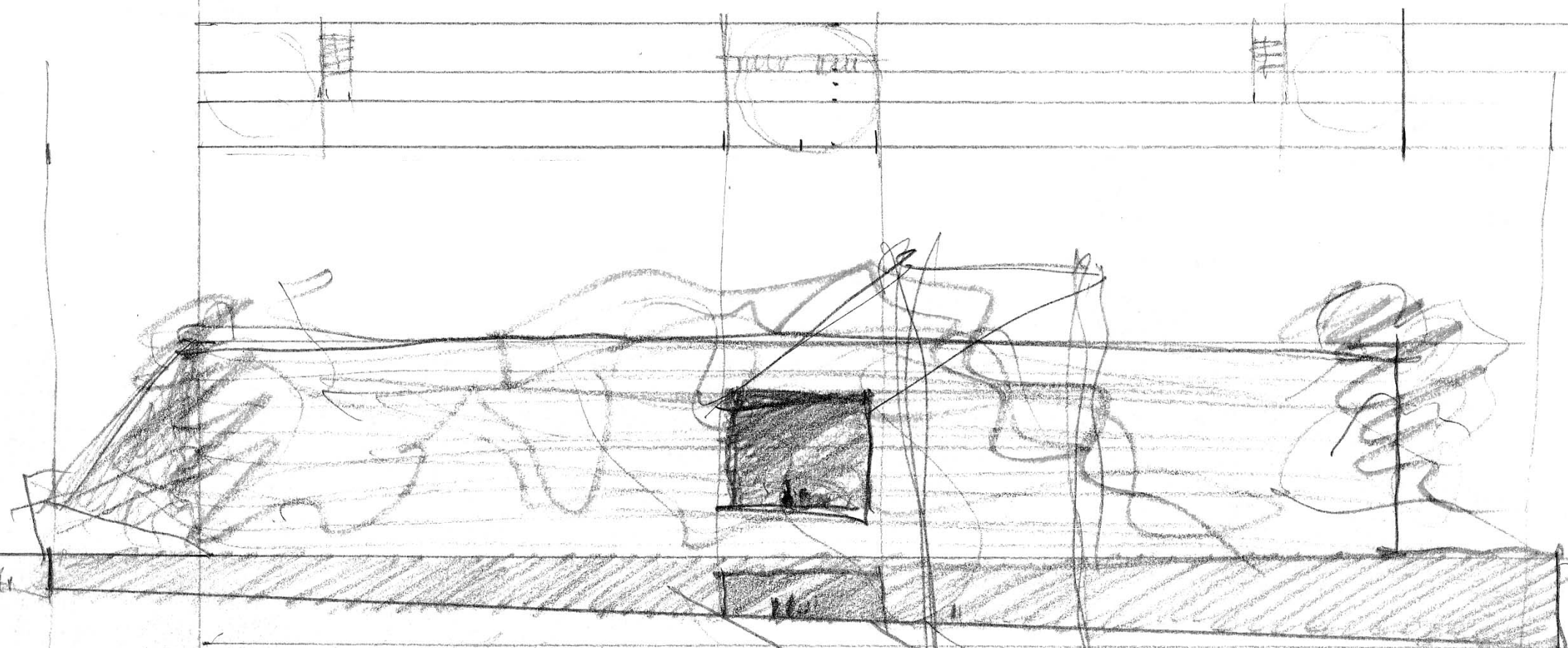
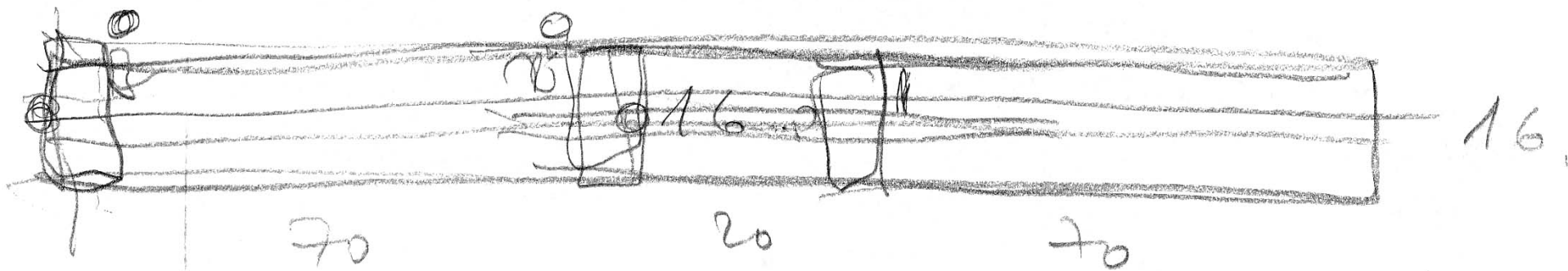

act

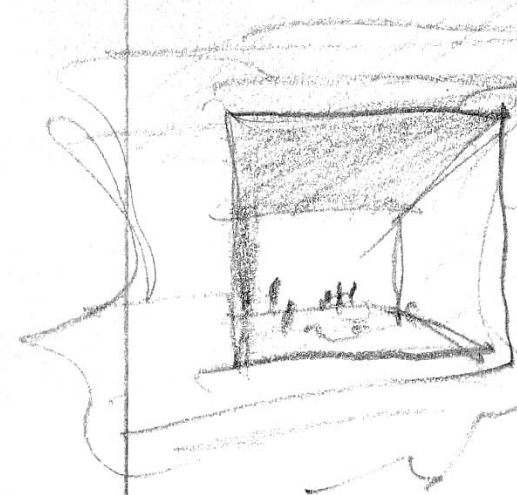

Jardines colgantes.
 Ineco en sombra (W) con W2.

ms
 May 19-1997

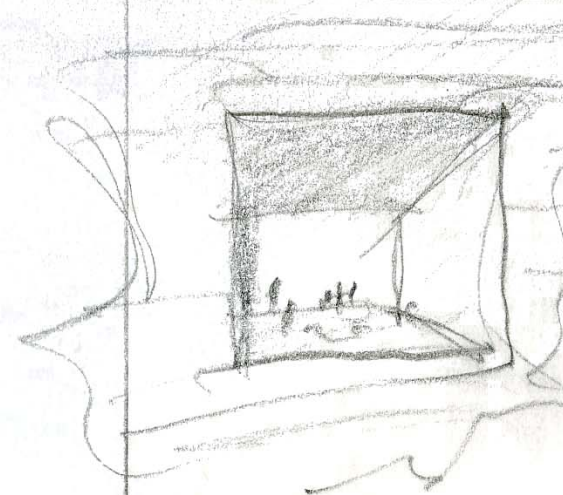
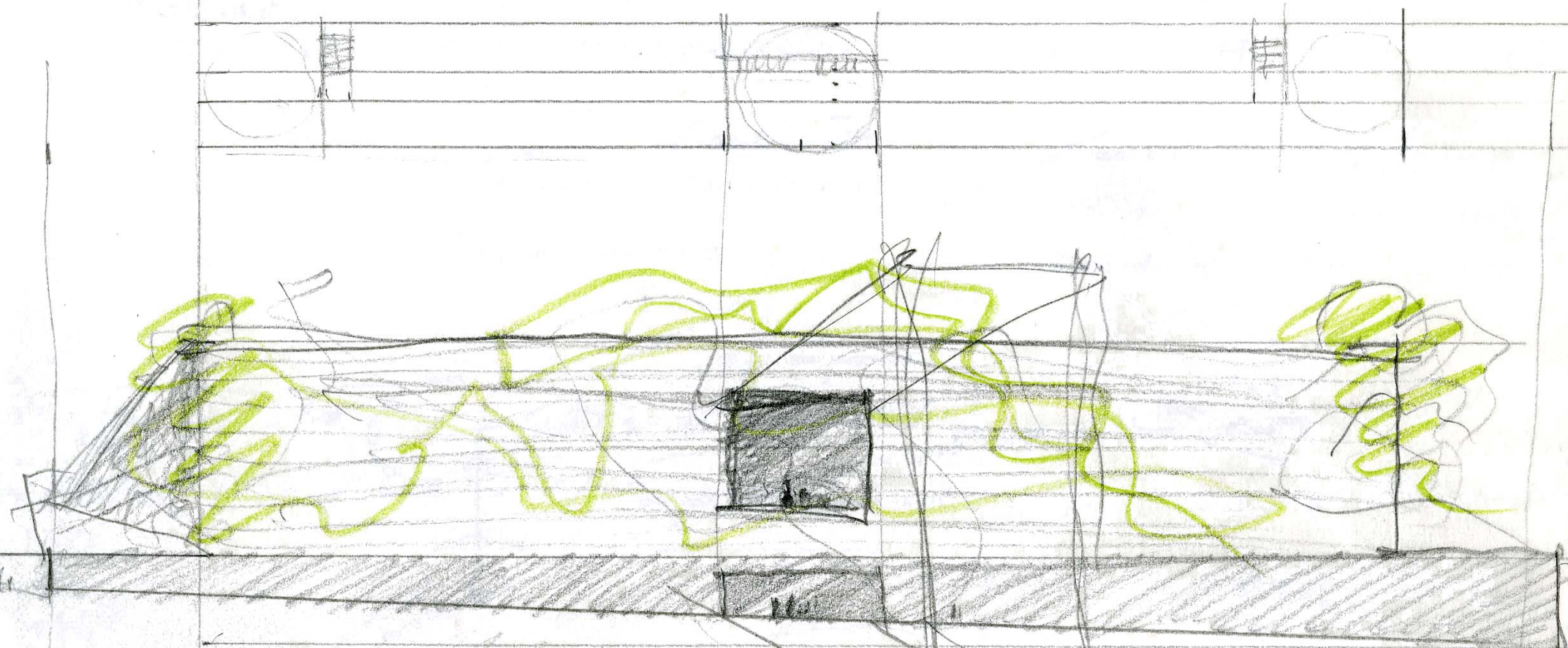
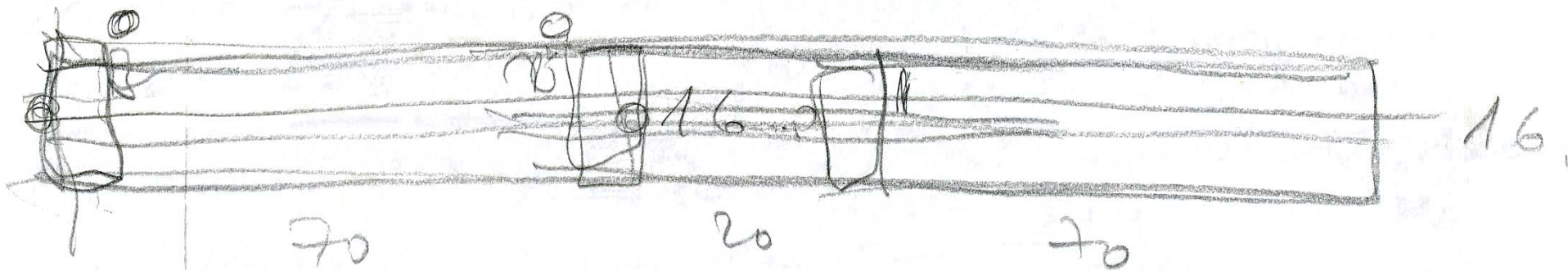

My
 May 19-1997

Jardines colgantes.
 Ineco en sombra (W) con W?

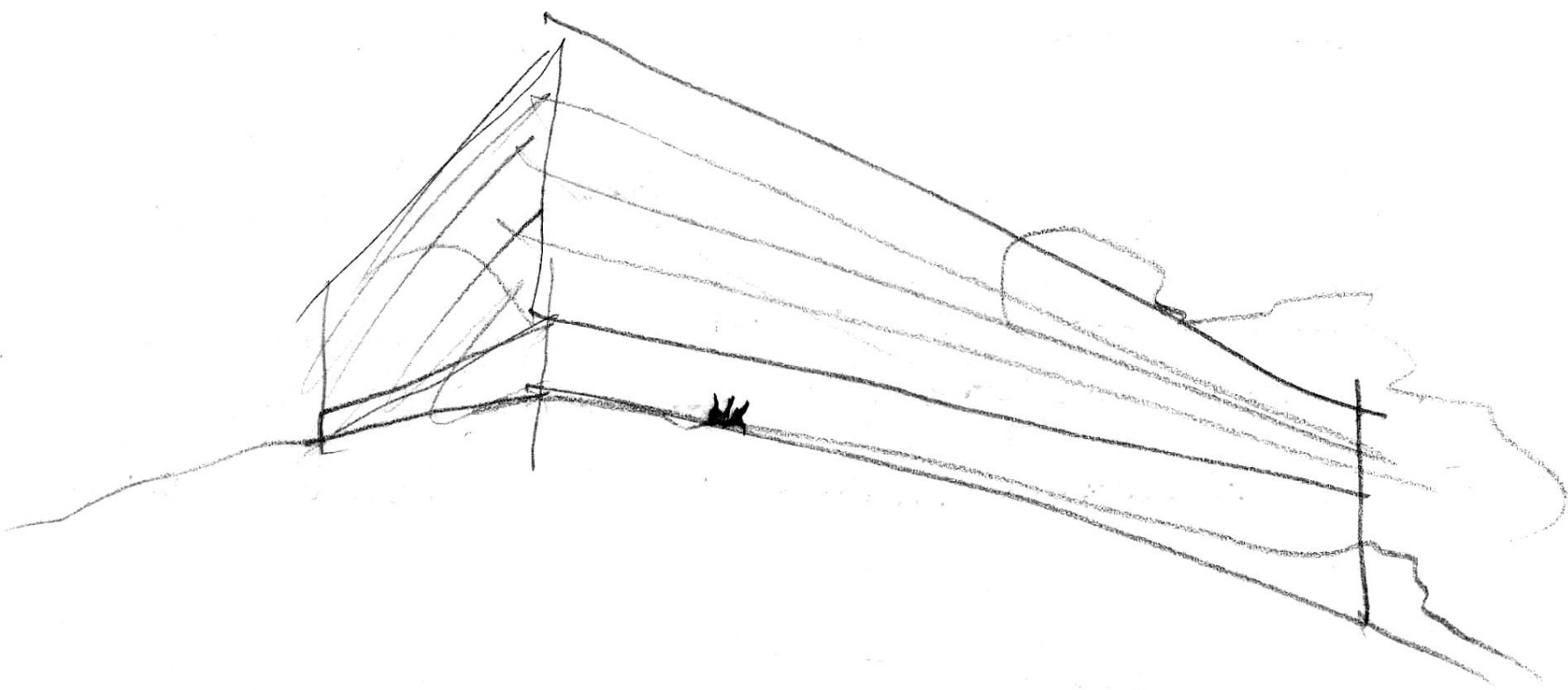
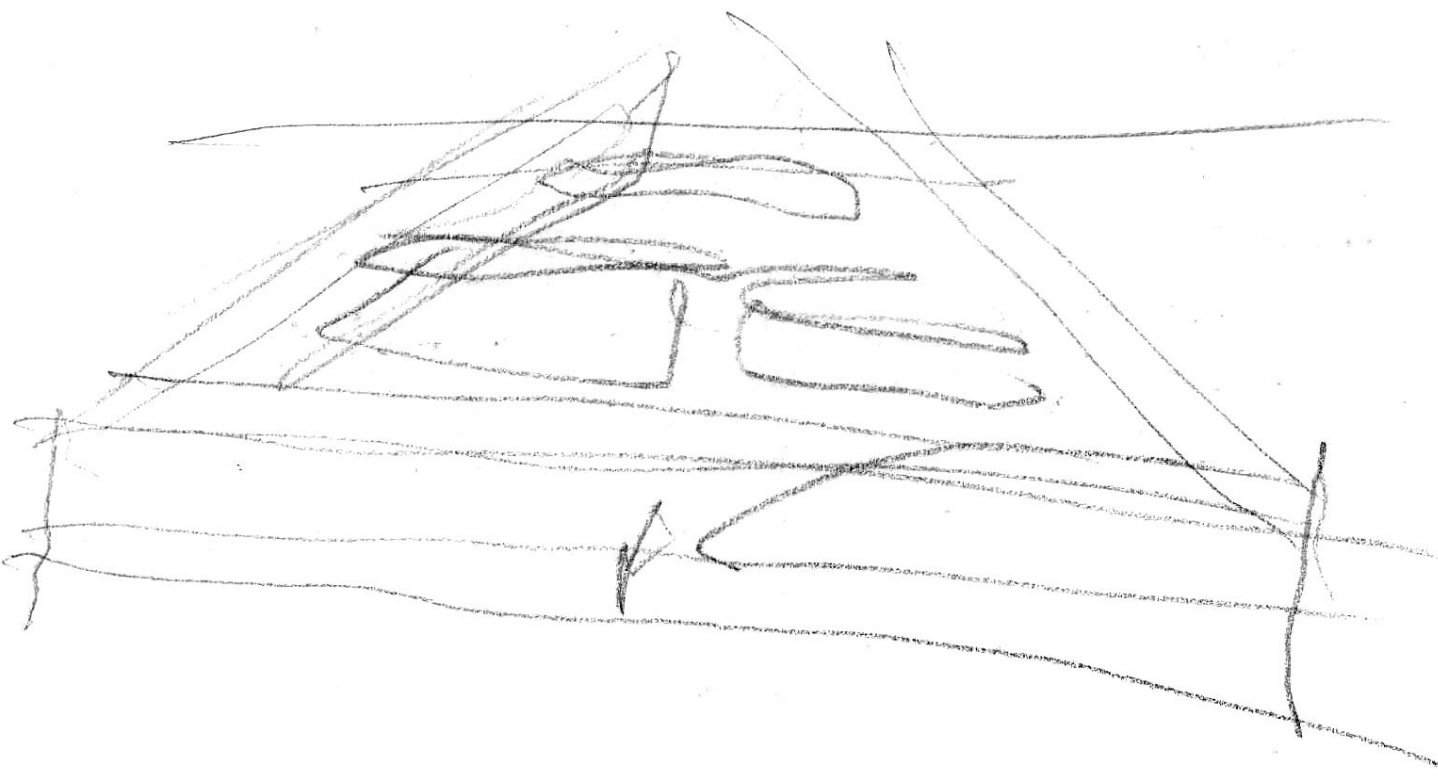

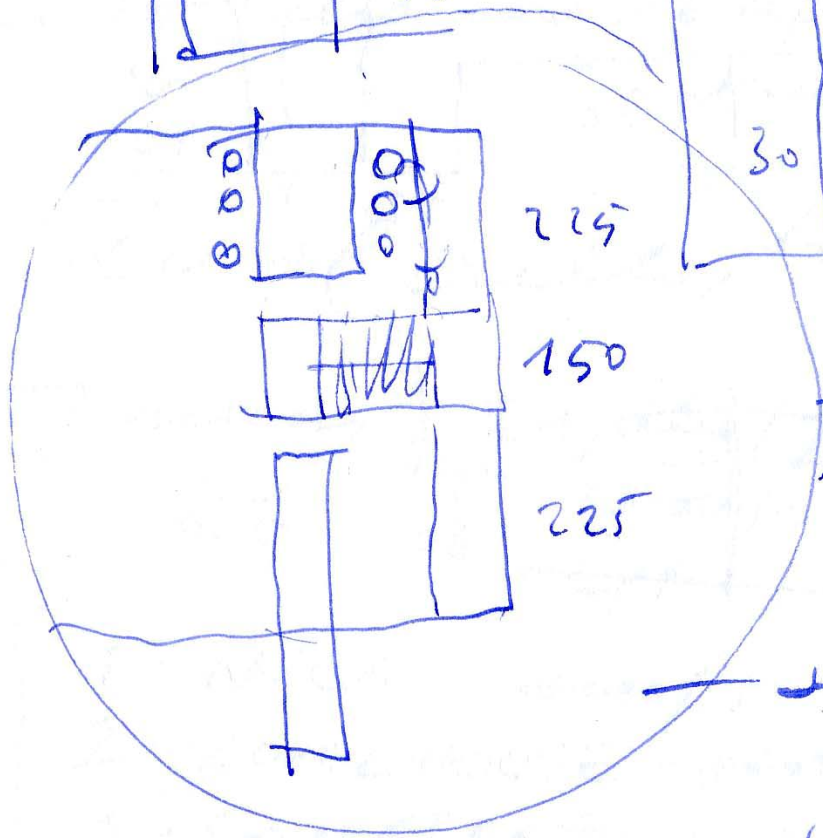
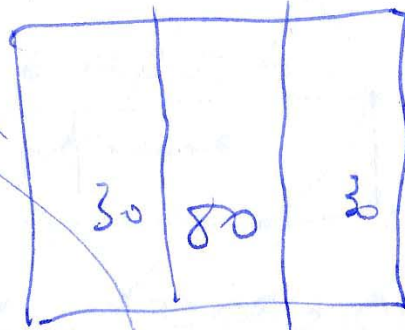
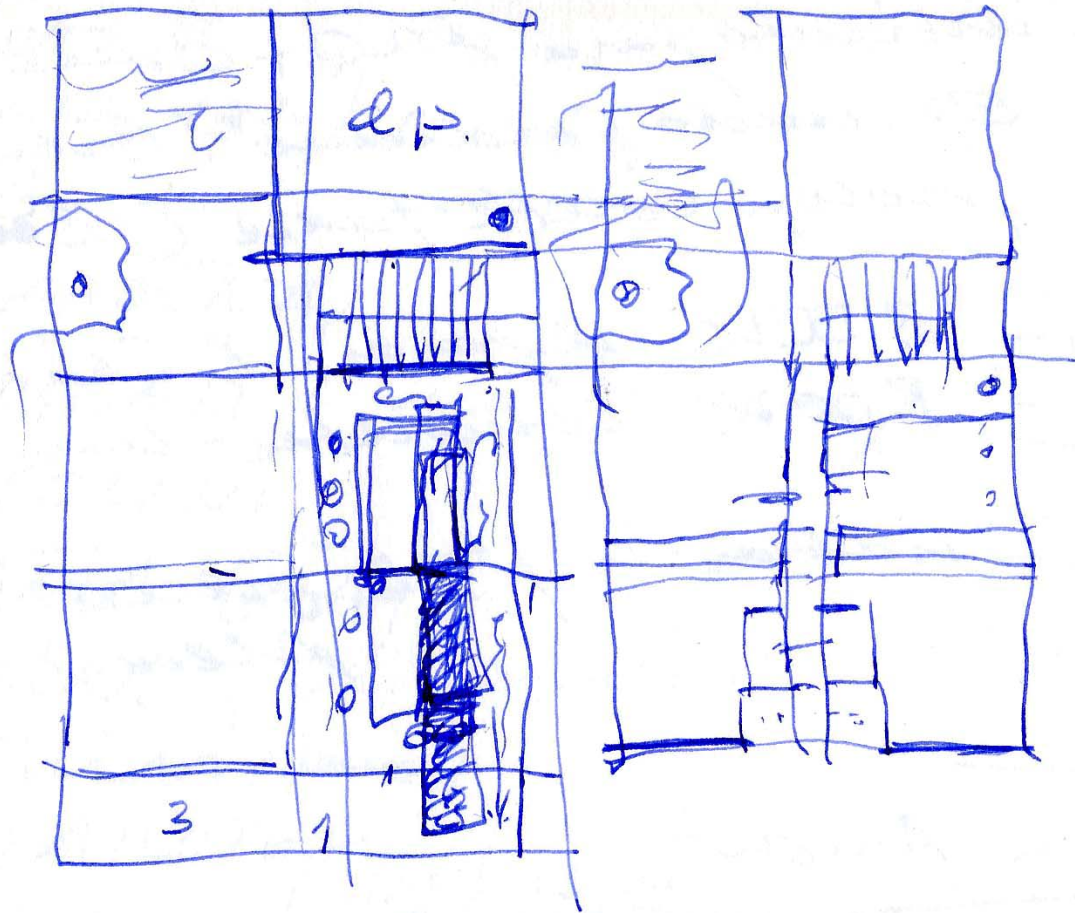
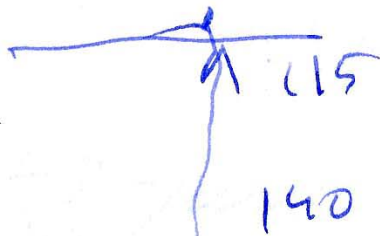
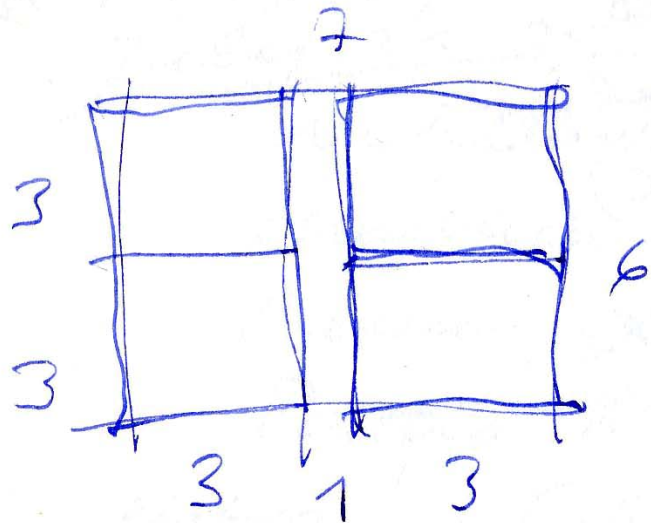

July 21, 95

— si la escalera no se
guadara hacia fuerte.

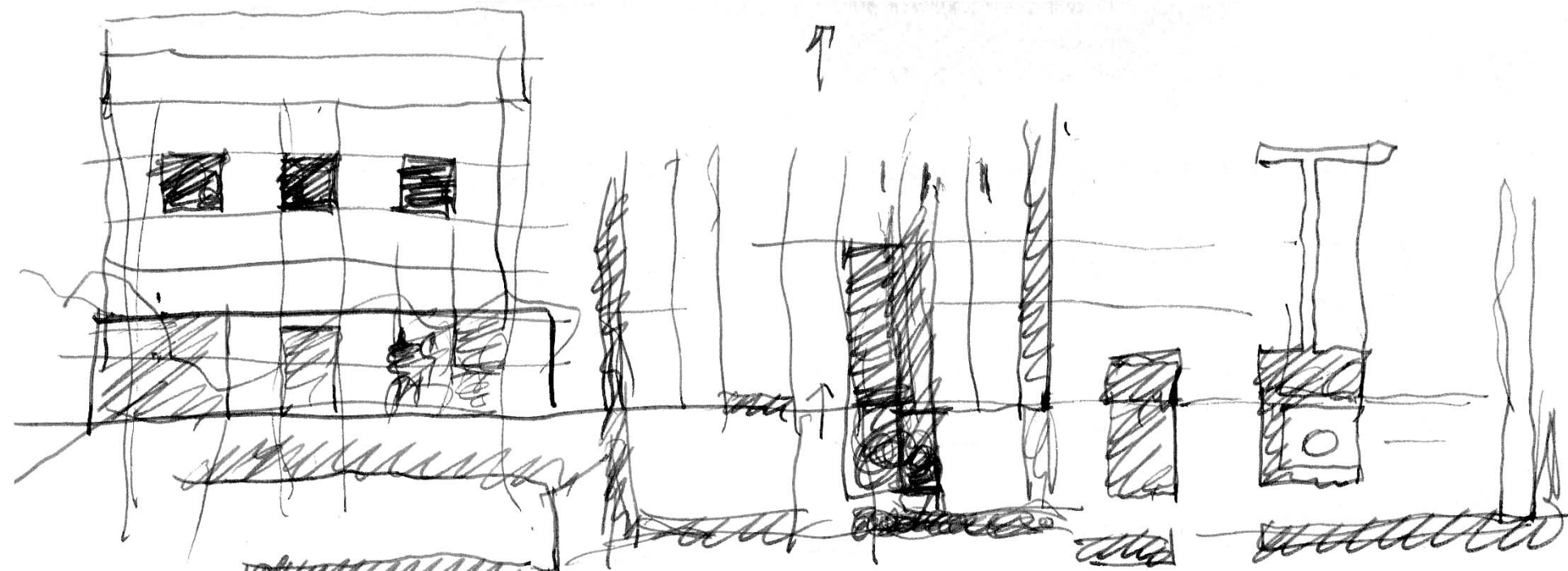

July 21. 95
LOP house -

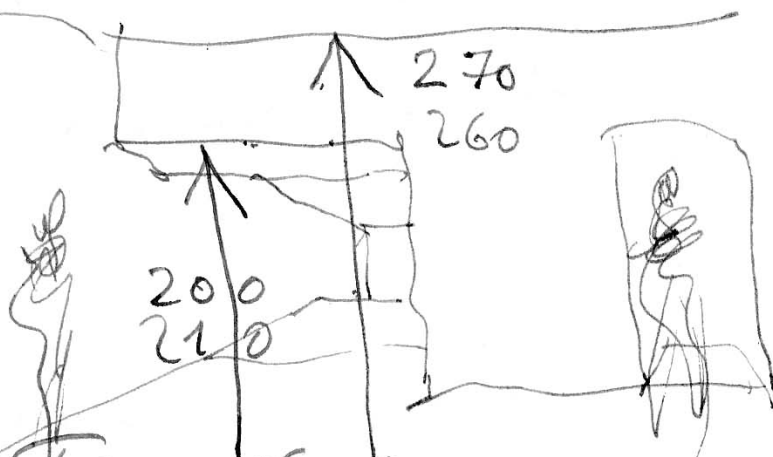

on the plane.
flying from Madrid to Frankfurt.

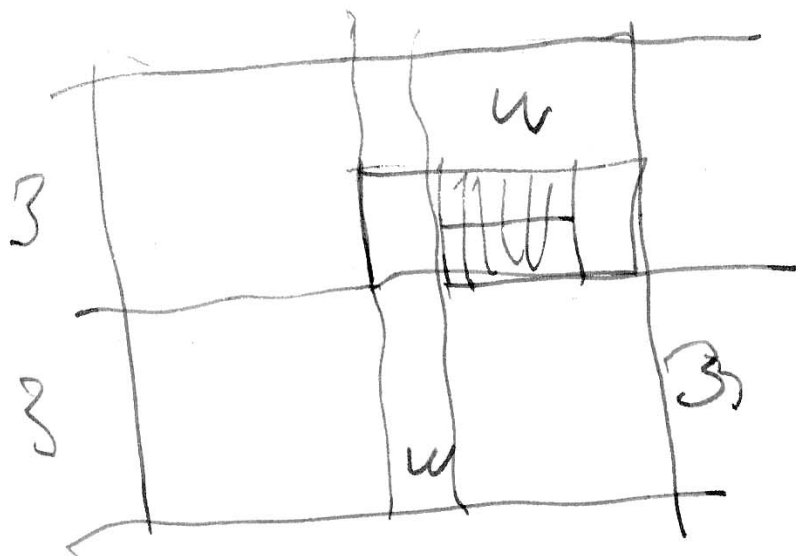

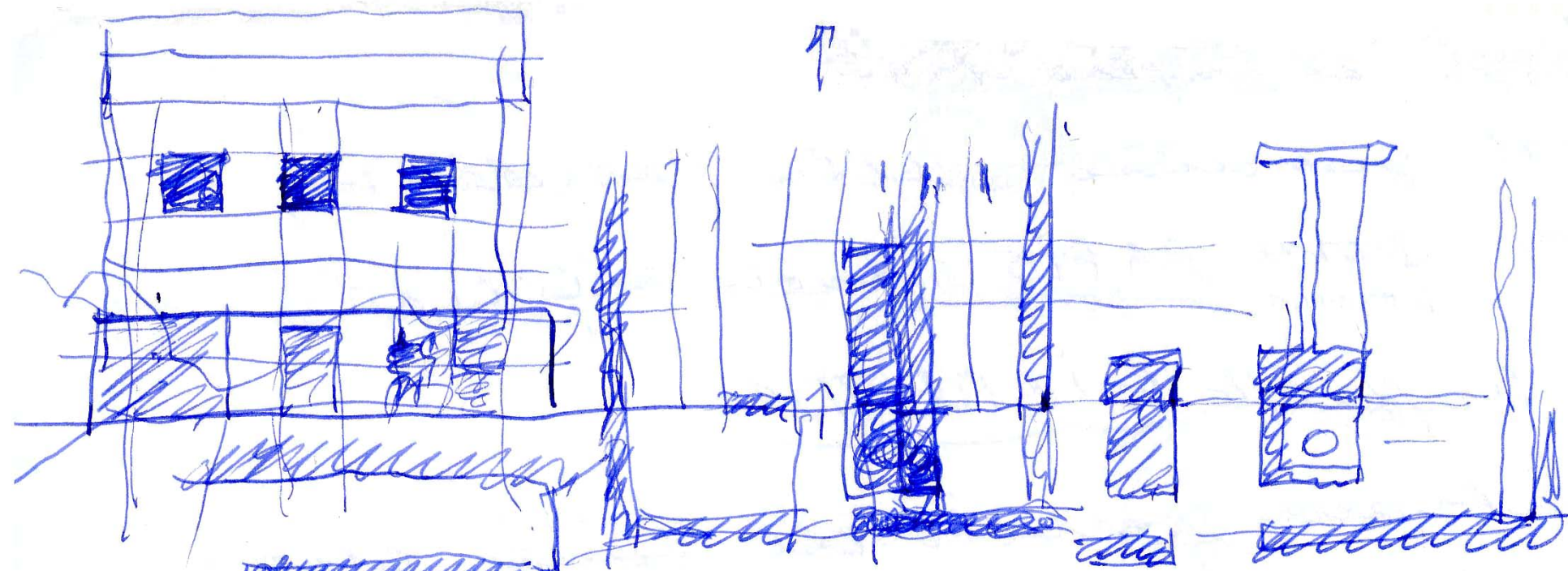

July 21. 95
LOP house.

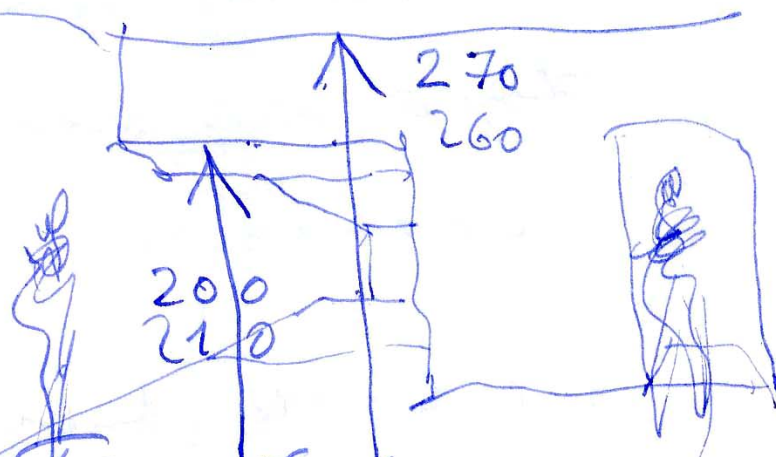

on the same.
flying from Madrid to Frankfurt.

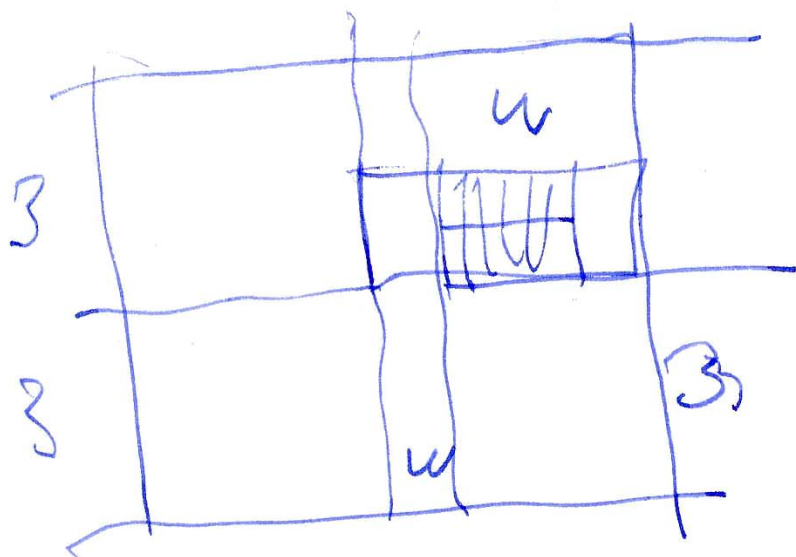

que hay que concretar y escribir.

Vefamos a BELFORTA dormir en este
pequeno hotel al Saint. Christophe, donde
no se está nada mal, es acogedor y
con agua caliente boca y limpia
(f.a.d. nothing). Un punto de inflexión
no p. - Yo creo que merece la pena no
pa.

Ayer cenamos en una creperie.
nada

y. Hoy 31 de agosto veremos
por fin Rouclancy. ¿qué pasará?

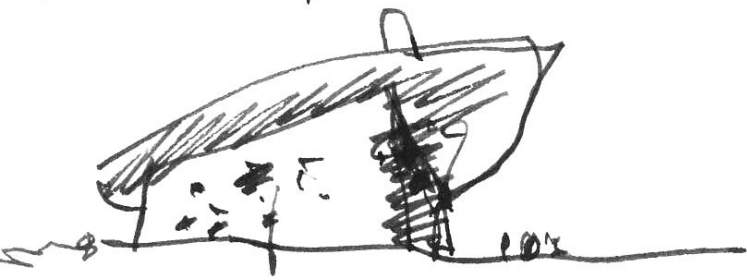



AVE VERUM people
 Mozart (from Salzburg)

Roumania August 31, 1955

4 more in contenance.

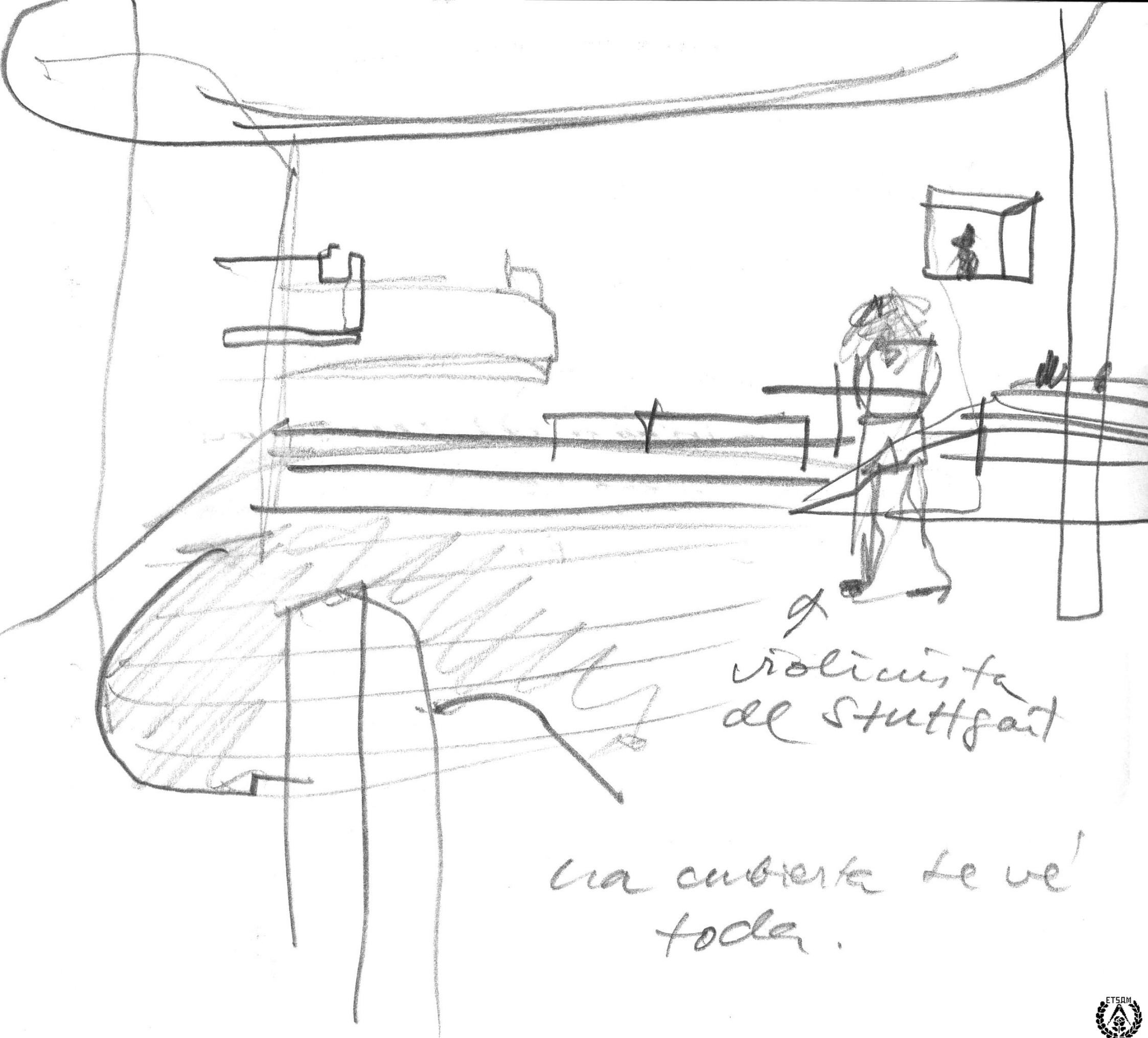

Violinista
de Stuttgart

Una cubierta se ve
toda.

no volvimos al hotel.

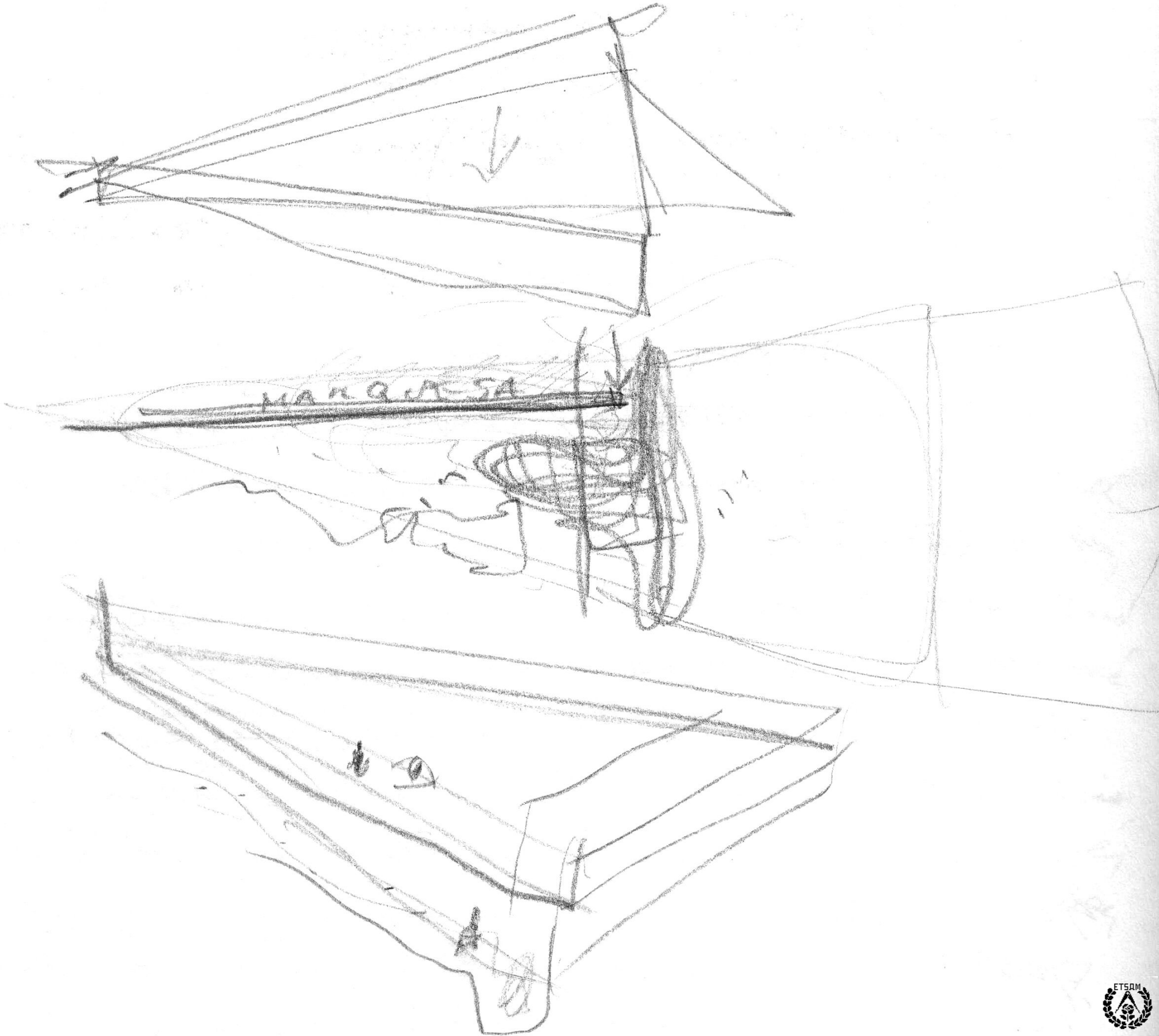

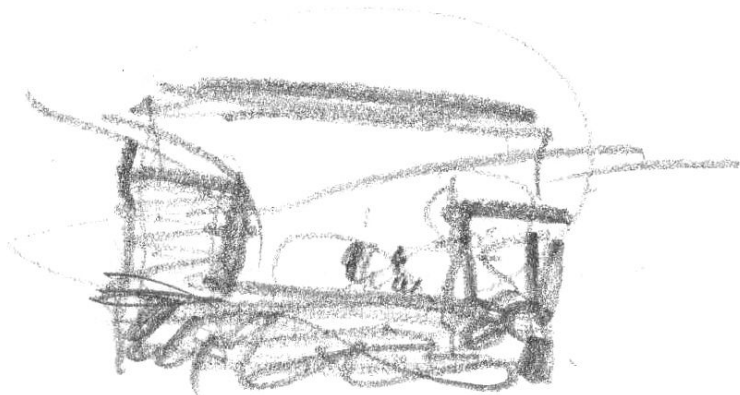

manda St. f. en v. de l.
a Juan 05



- Paris. Le 2 août de 1995. en el hotel
PERREYVE. a las 9.30 de la mañana, voy
a ir a ver la maison de verre y la
VILLA SAVOIE a Poissy y quedará la casa
de Tritan Tzara de Loos. todo esto
sendamente. Estoy muy feliz. No acabo



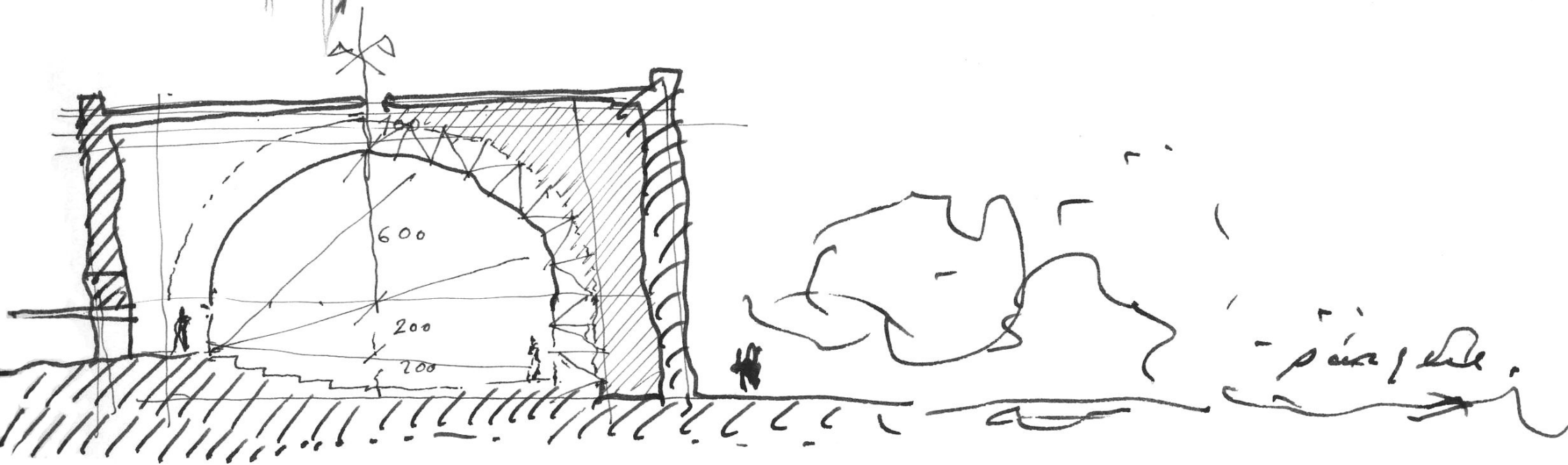
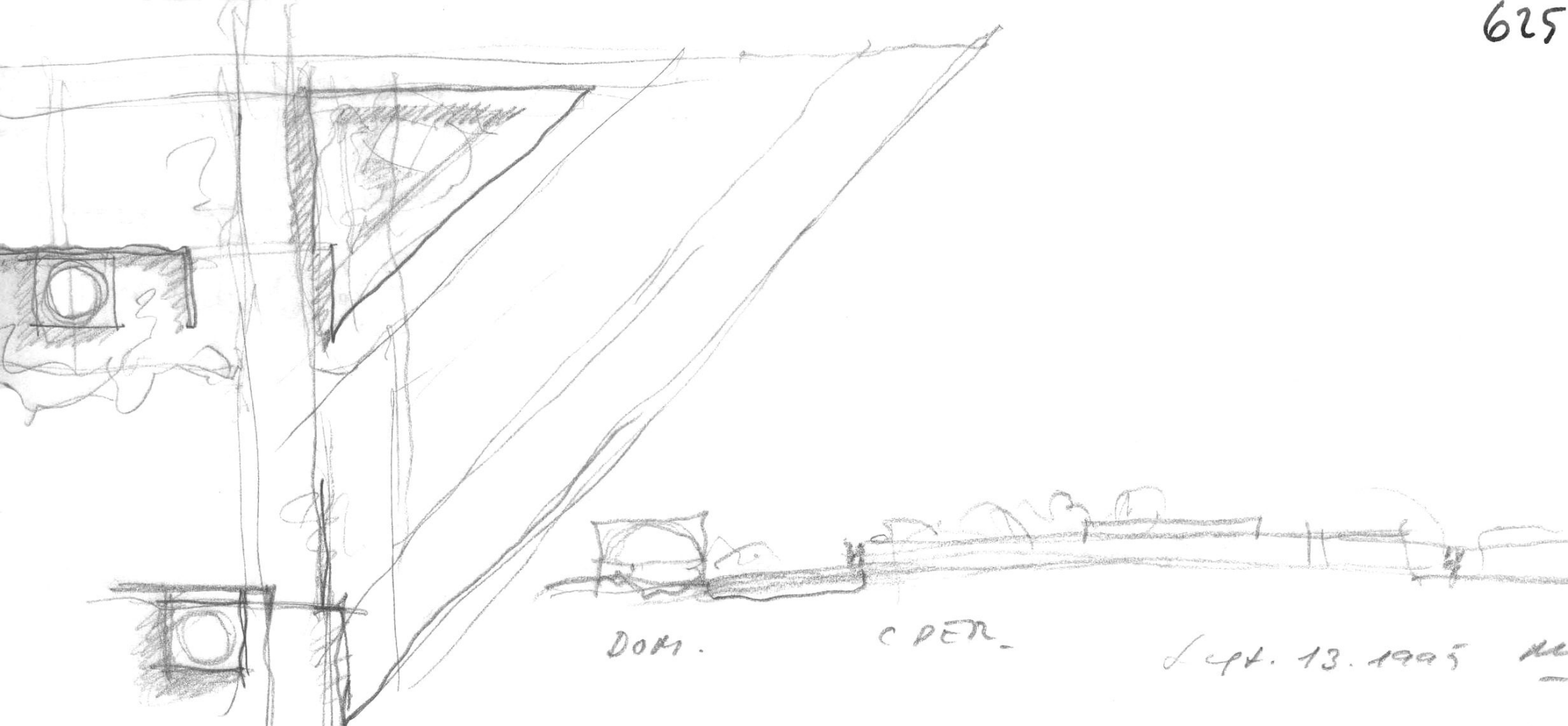

Sept. 14. 1995.

DOM / Centre BIT RAIGUEN.

(ing. Rafael Vidal)

Salvador Sandoz.



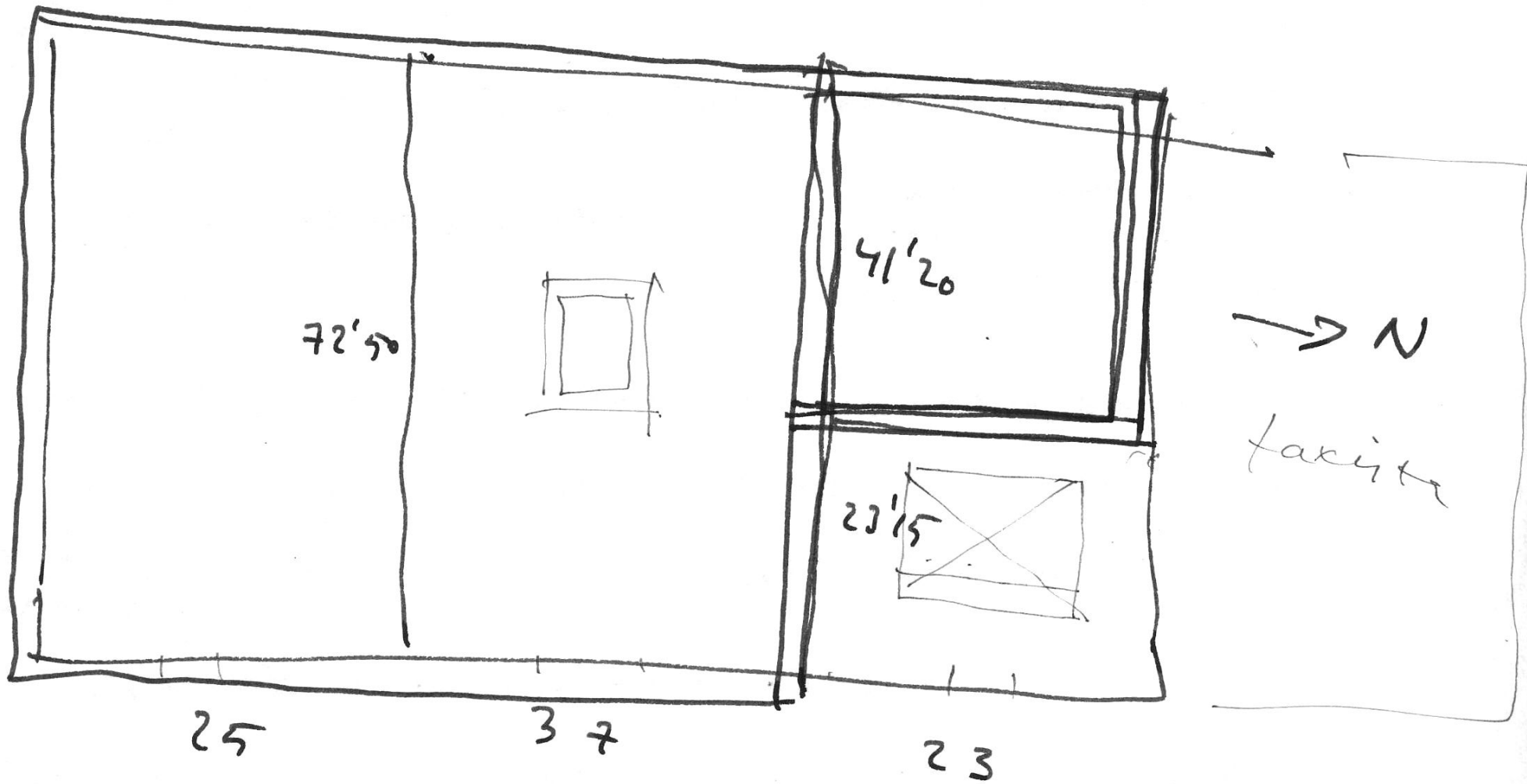

62
62
75
65

264

41'20
23'15

6435

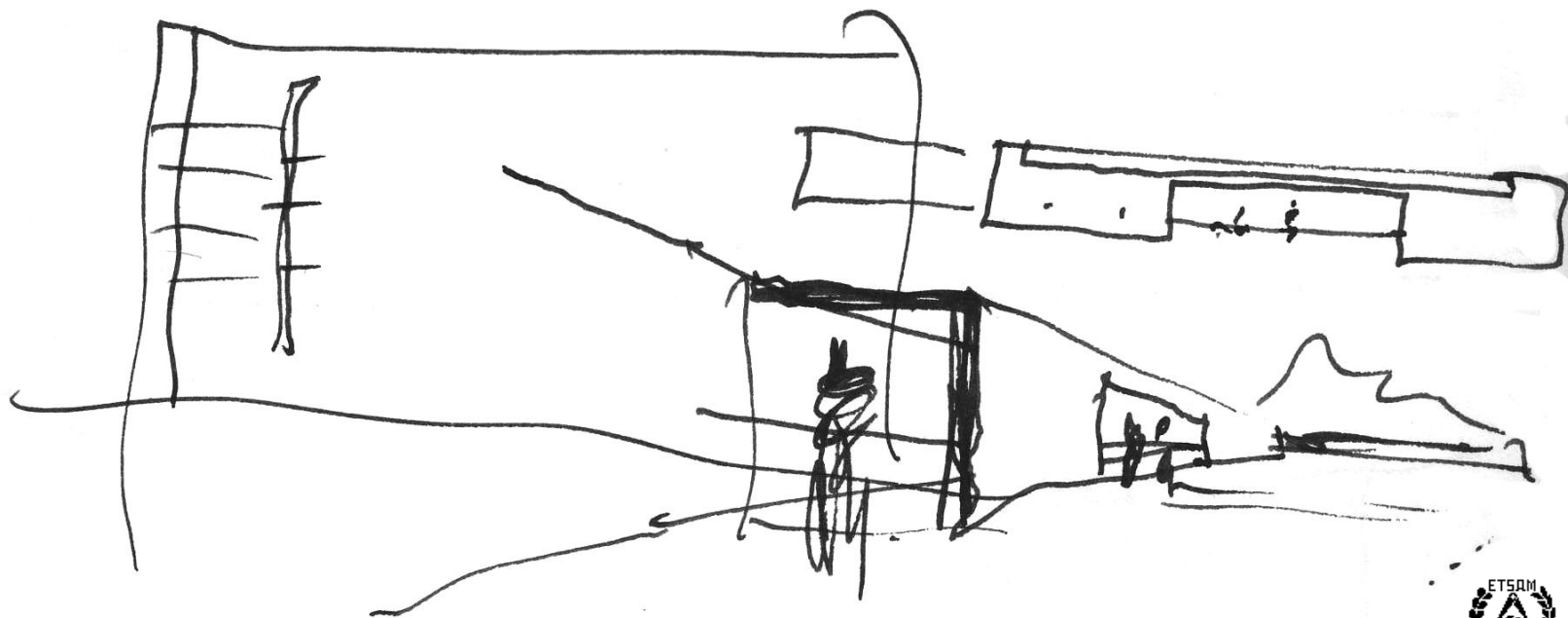

CADIZ. September 17. 1995.

temas pendientes.

W.

- MAJORCA
- GRANADA. / MAE.
- RICHI
- VIOLETA
- JOURDAU / LOECHES?
- V. de O. / ?

ETSAM

- LUGAR
- ESTRUCTURA.
- TEXTO.
- Permisos.
- listas.
- Carta.

LIBROS

- BOOK. estar pendiente.
- introducción CORRER.
- BOOK. push.
- introducción C.J.
- ELECTA. estar pendiente.
- ROCKPORT. escribir.

IMGE

- KA.
- Dinamarca.
- Downs
- Casabella
- OESTE
- BRUSELA / LJUBLJANA
- LISBOA.
- BLACKSBURG USA.
- COPENHAGEN.
- TALLINN.

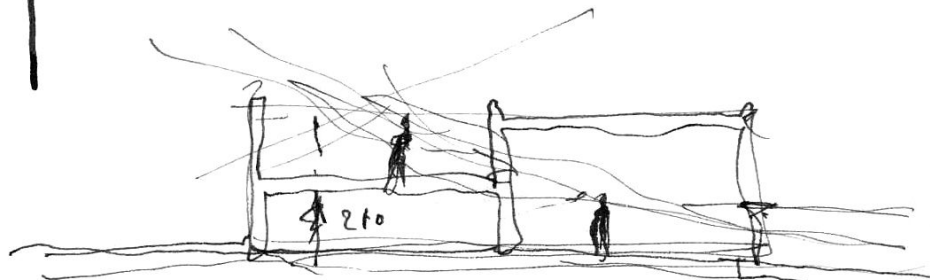
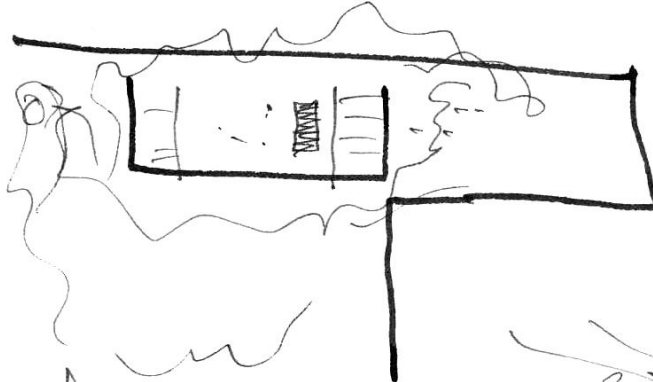
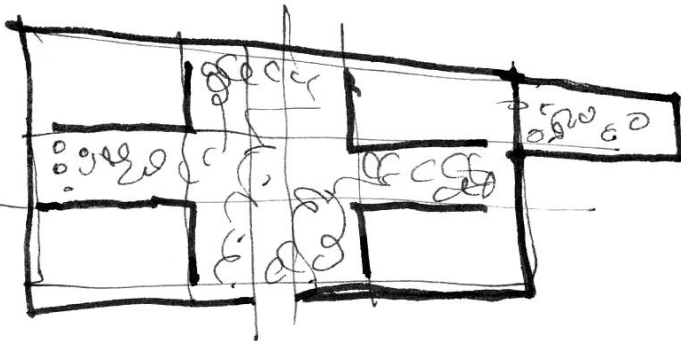

pag
Merica
CHICLANA

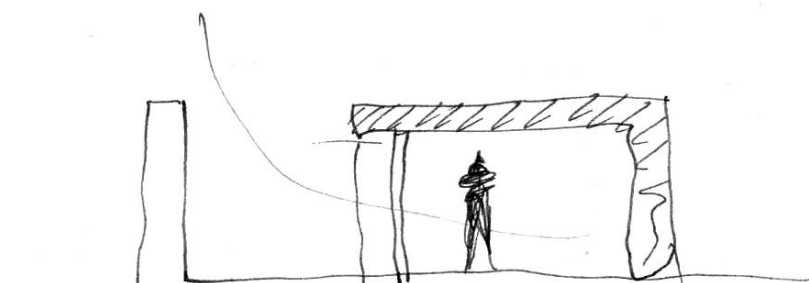
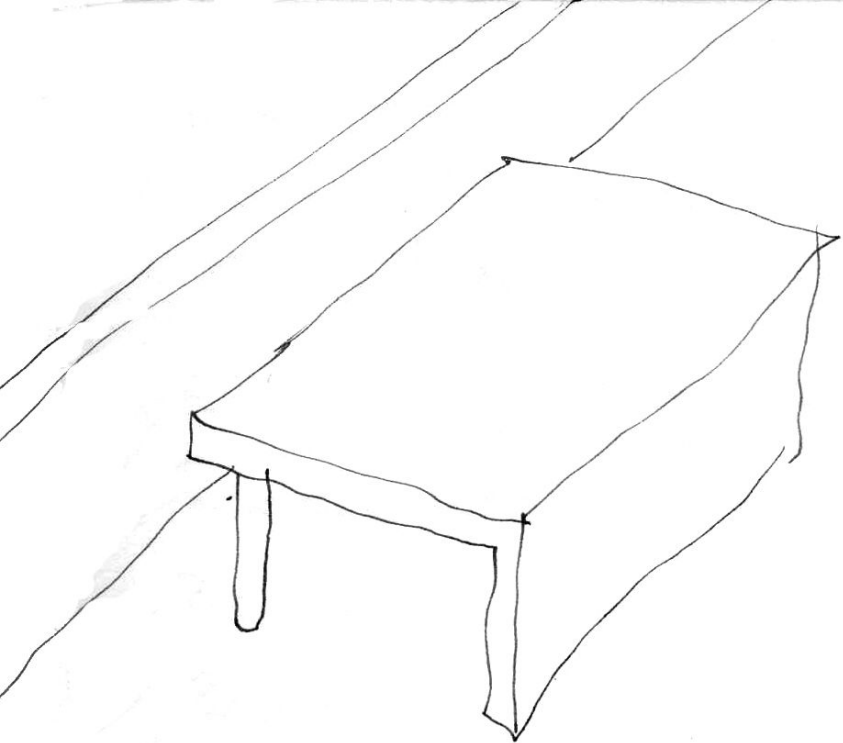

Chidana September 17. 1999

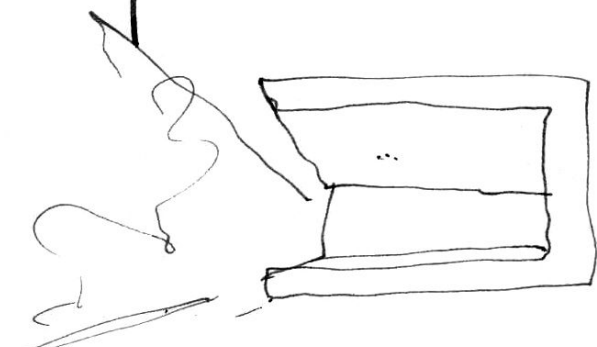
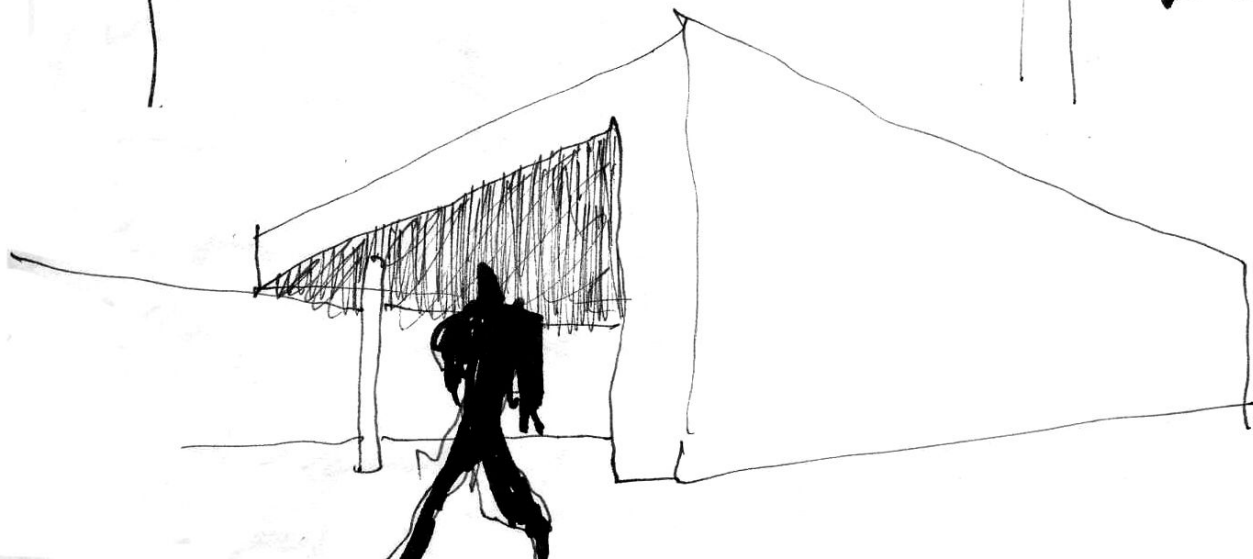
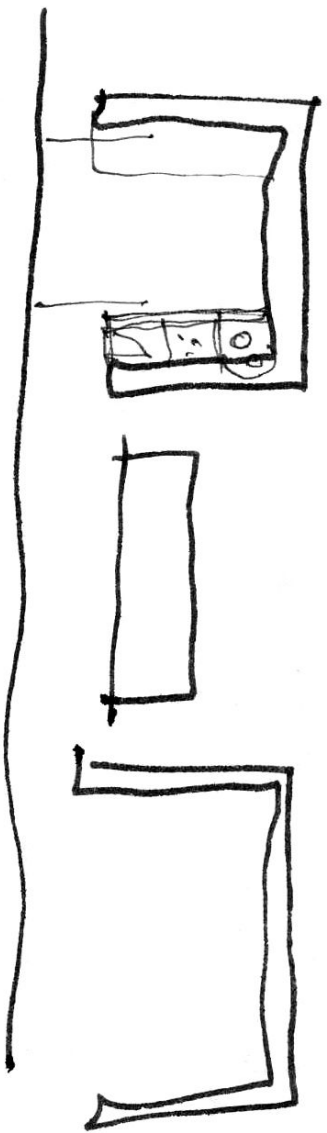
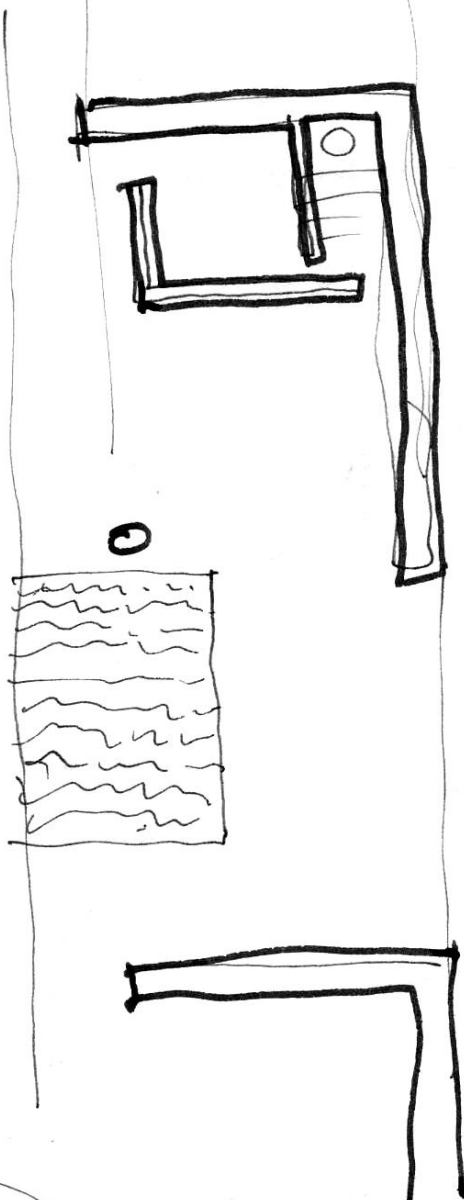
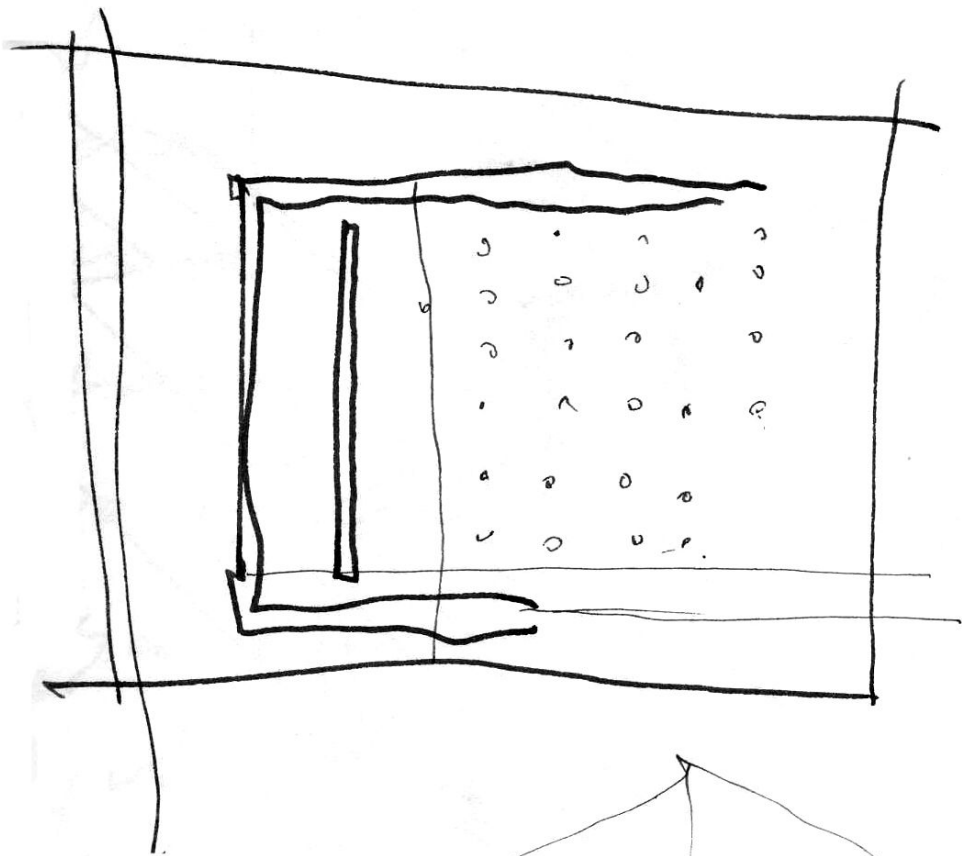

September 17, 1995

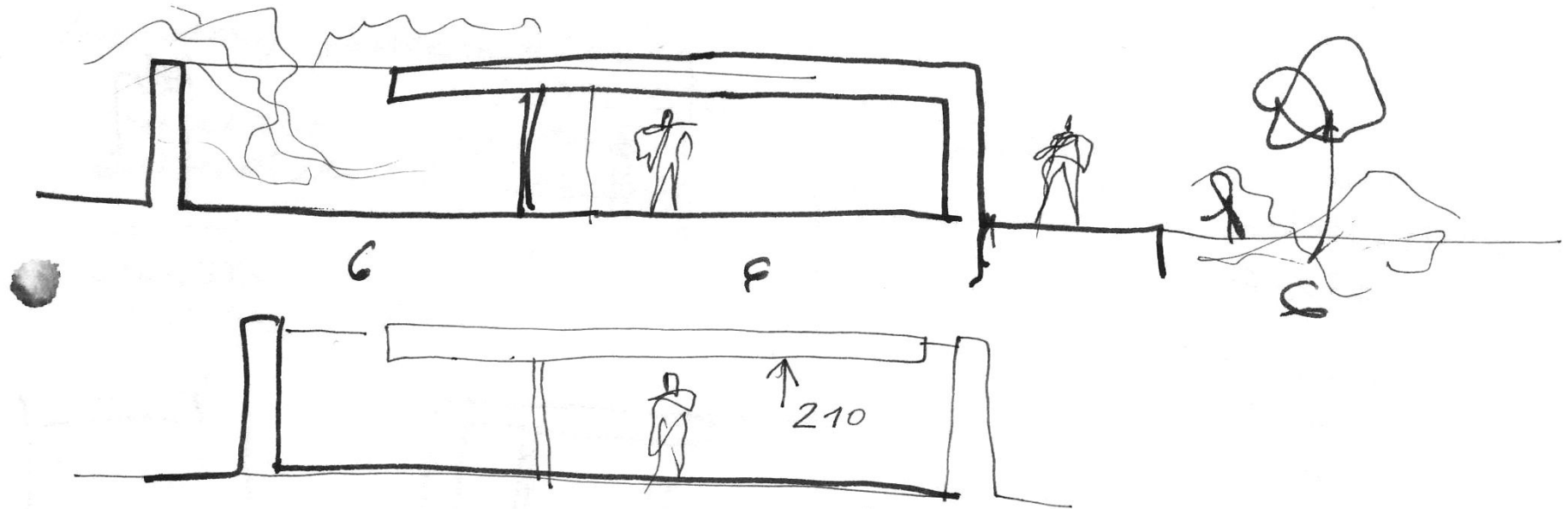

cerrado

cubierto
abierto

descubierta
cerrado.

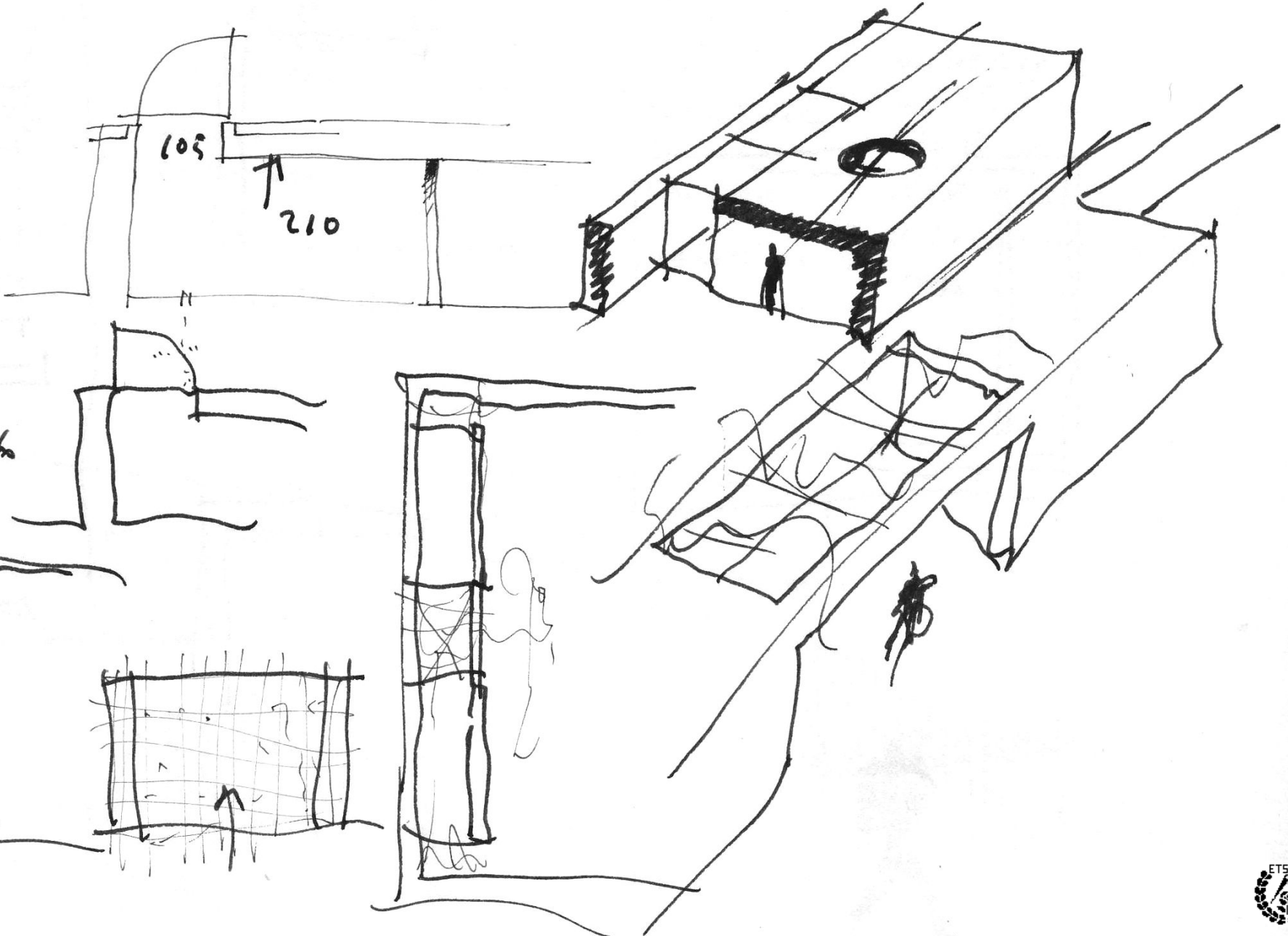



el sábado 24
vi una casa de

JULIEN LAMPENS,
magistral

casa de los
años 60
[buscarse]



tiene que ver con INCA
MAYORCA

estruendo

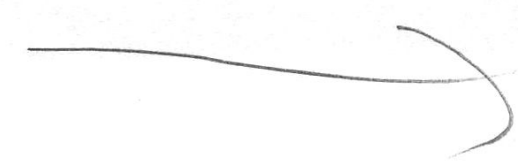
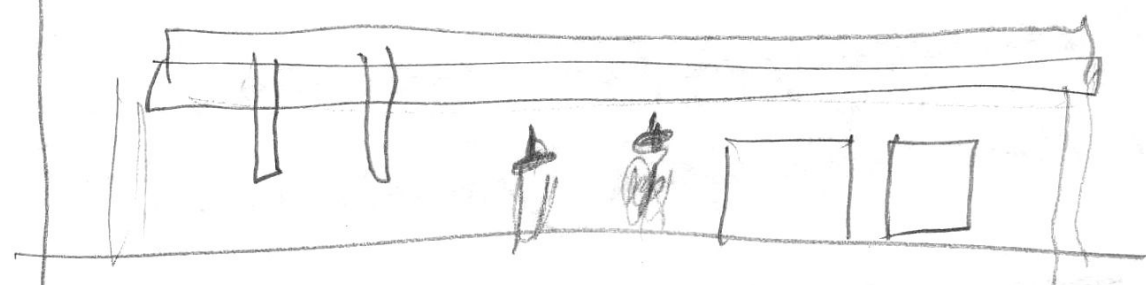
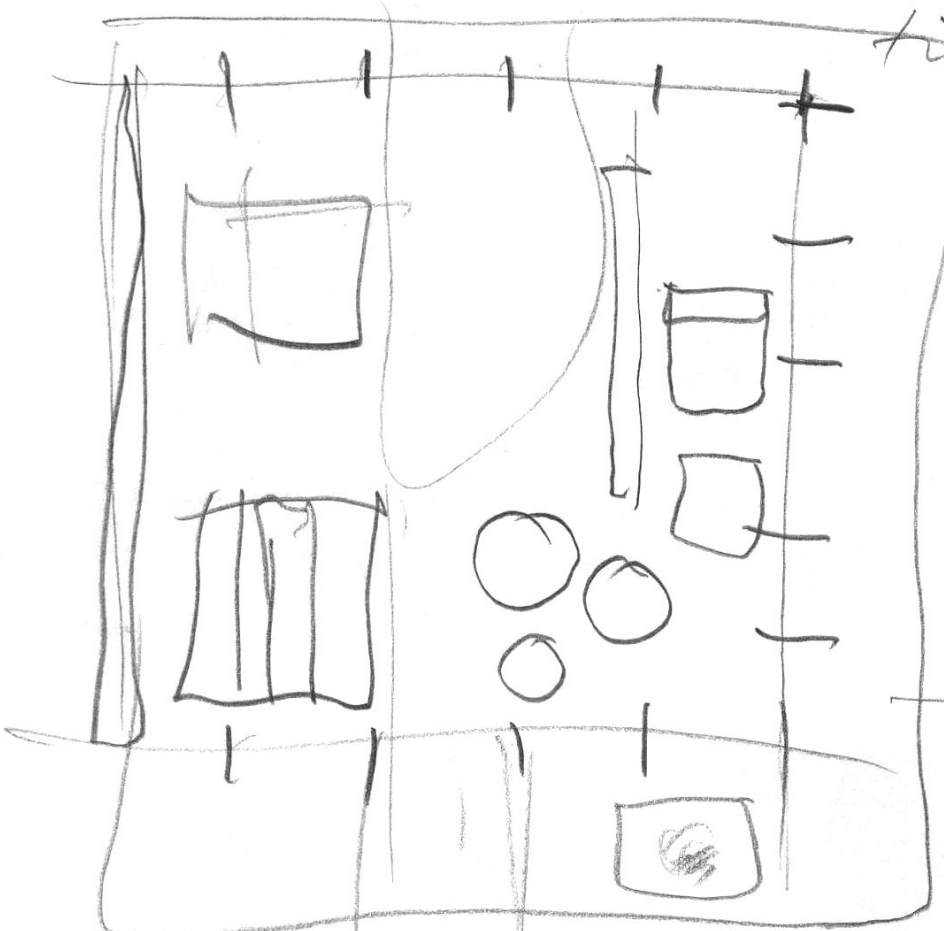

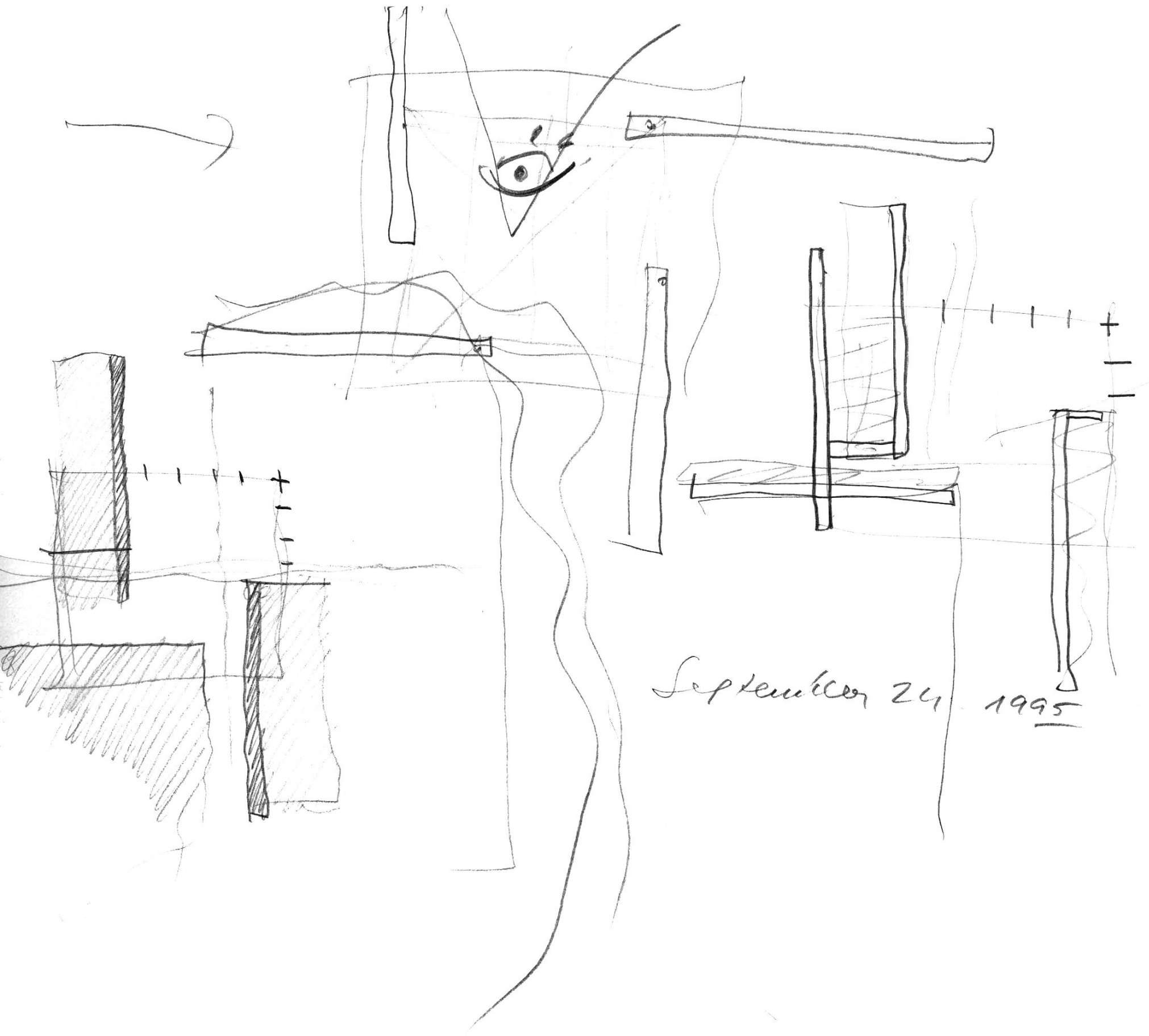

September 24, 1995

Sabeena es una pena

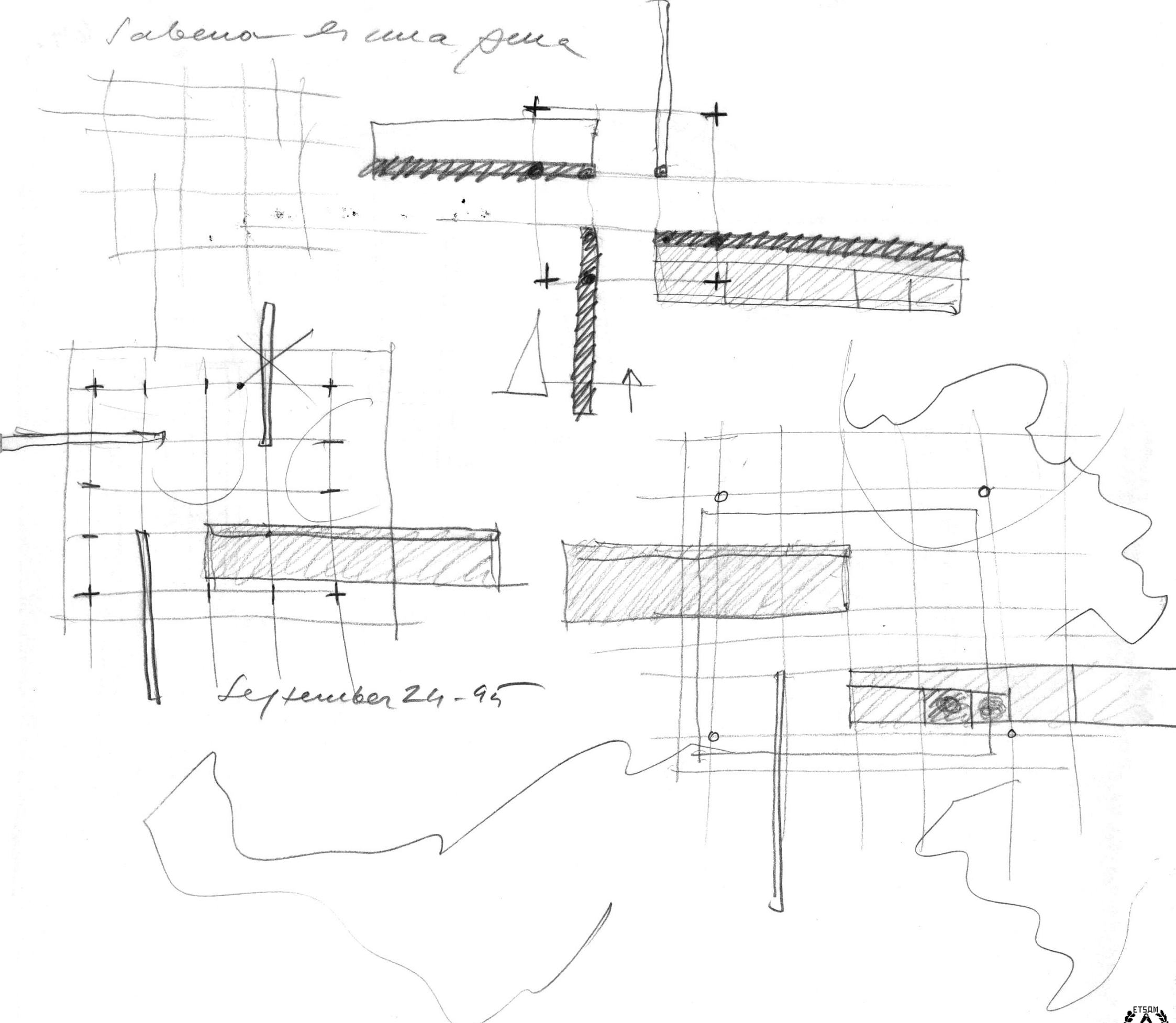

September 24-95

TO

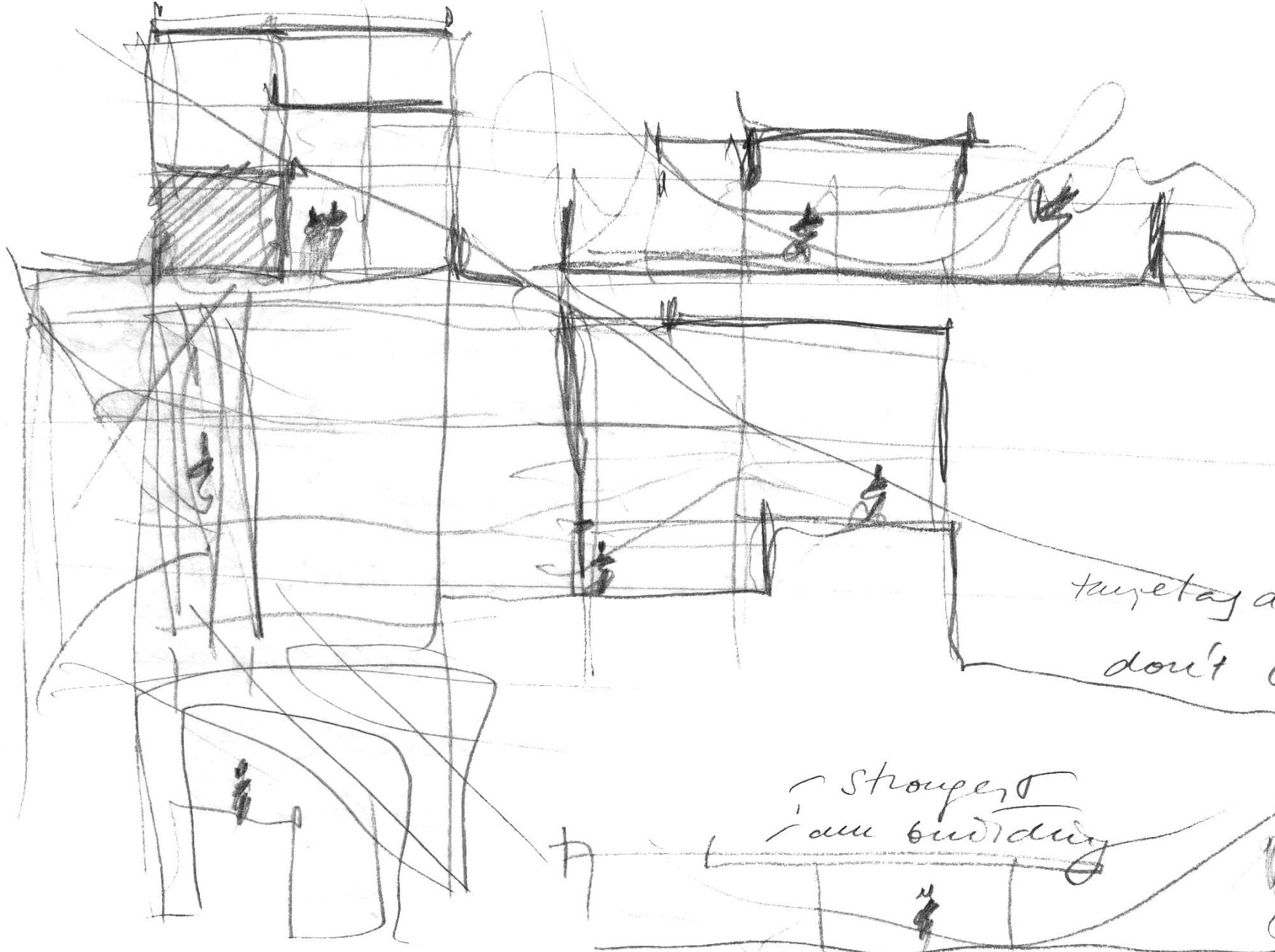

tuyetaya
don't be shy!

strongest
i am building

TO

JDS !!

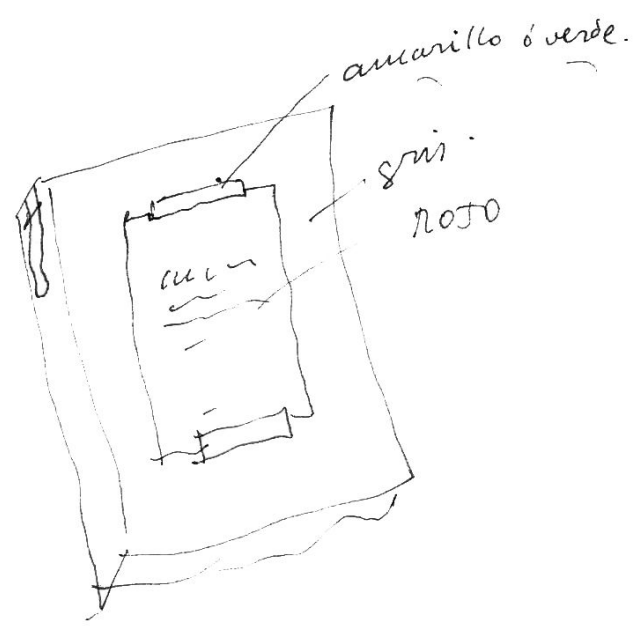

7



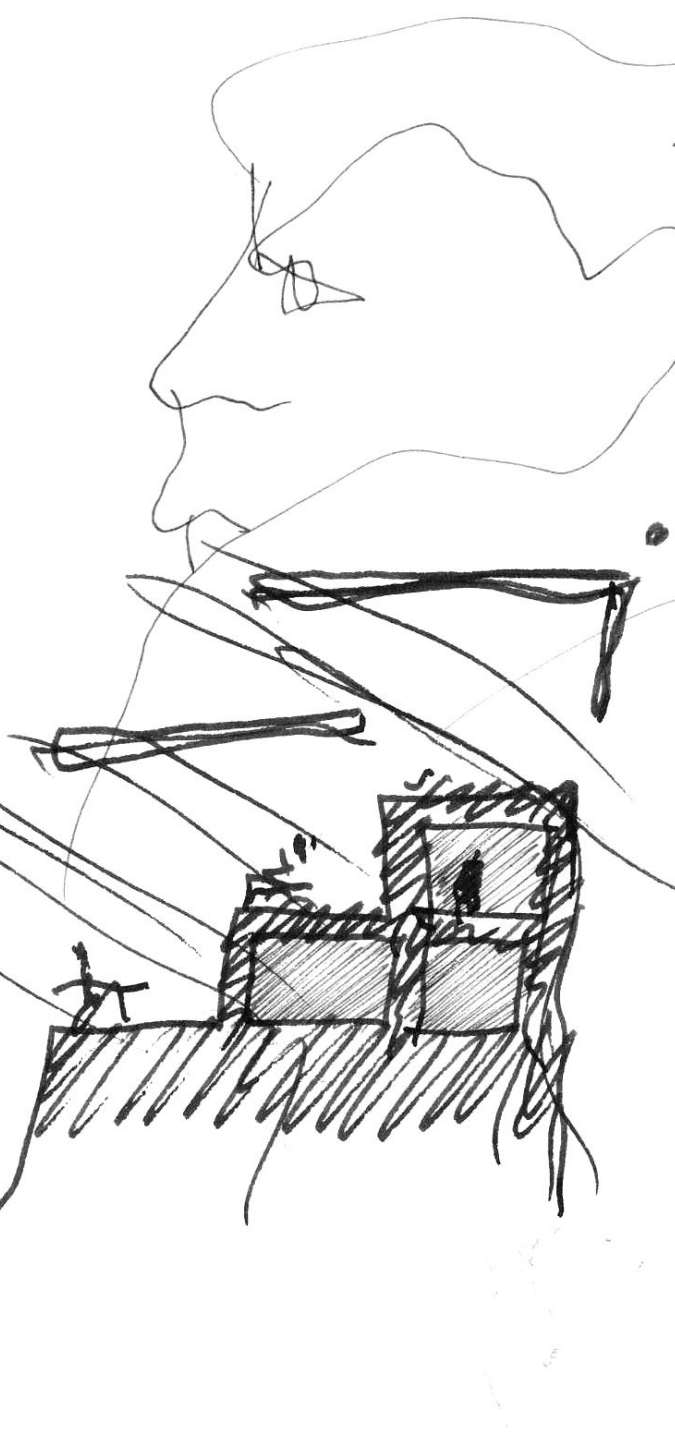

- > texto UTZON
- > texto J. CAADO.
- > texto MAS MAZ
- > texto (kuro - JDS. -
- > texto EVALUA
- > Temi Mauri
- > libro a niños a color
- > Falcanelo'
- > preparar OPP.

