

G.A.D. no. 100

25 julio 2006 comencé este cuaderno.

G 21

27 julio

2006

JULY 2006



○ aeropuerto de Vuelca) -> ciudad. Vuelo a las 19⁰⁵.
el avión está delante.
ideas para Jueves

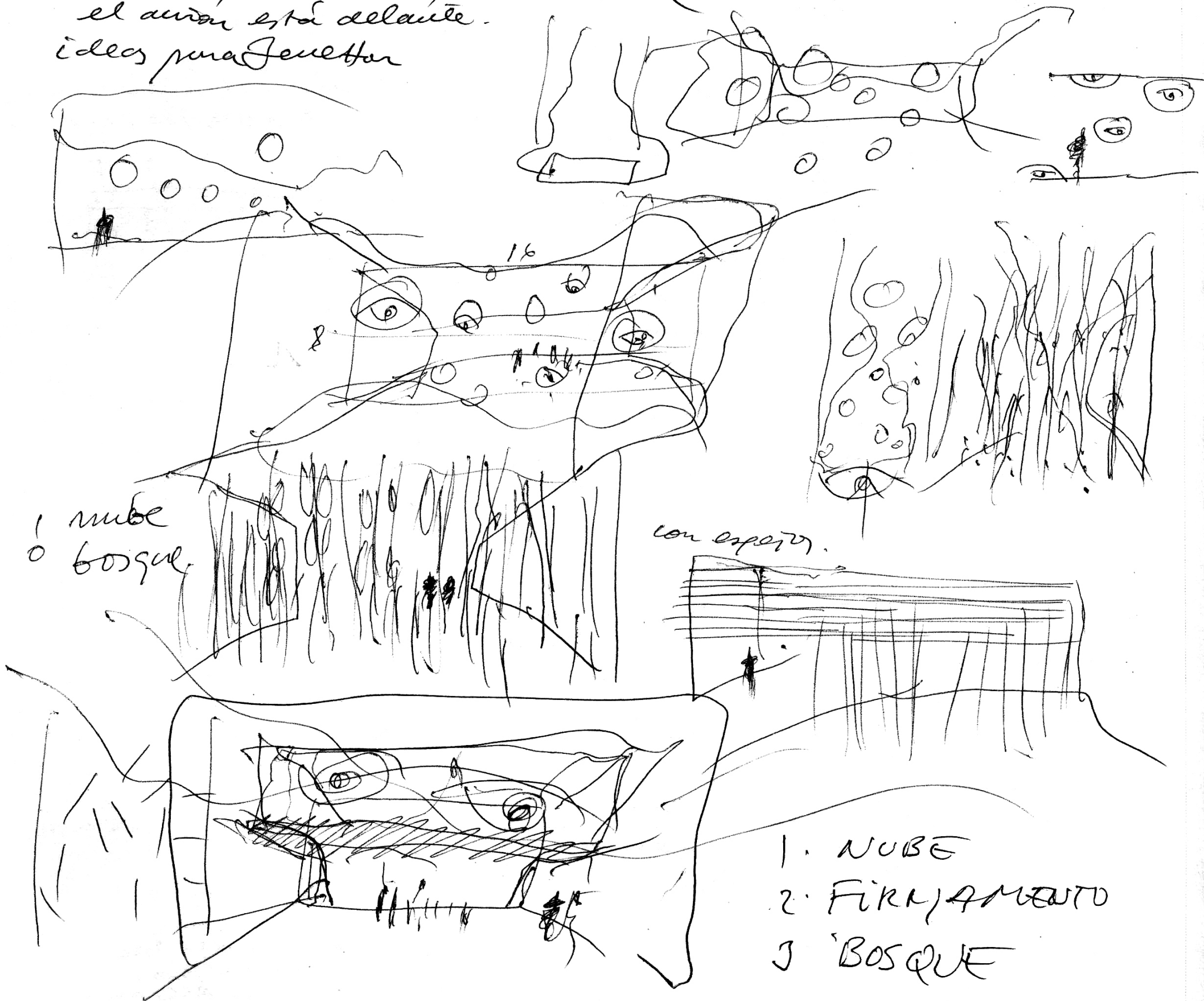

1. NUBE
2. FIRMIAMENTO
3. BOSQUE

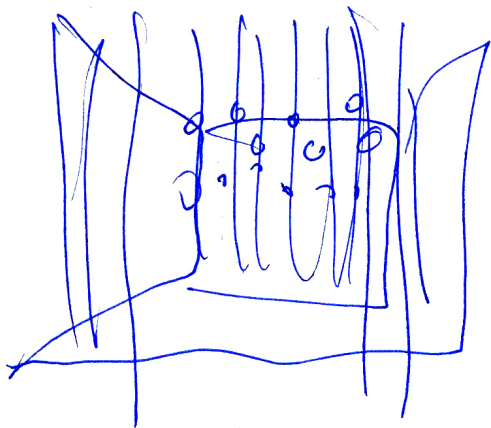

Bosco

sospeso degli
alberi



NUBOLA

galeggiante

searching for October 21 2008

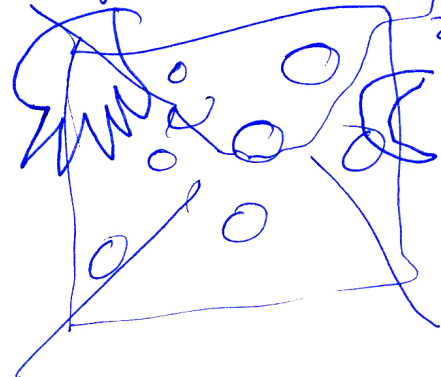

STELLAE!

galattica.

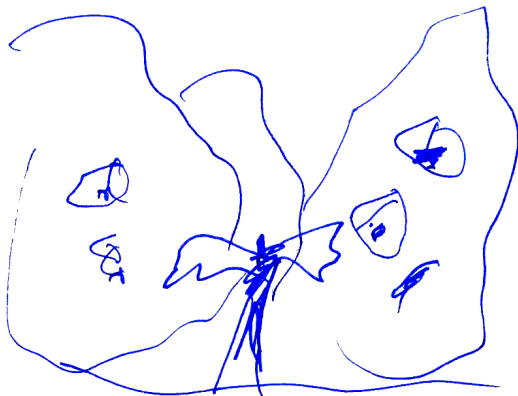
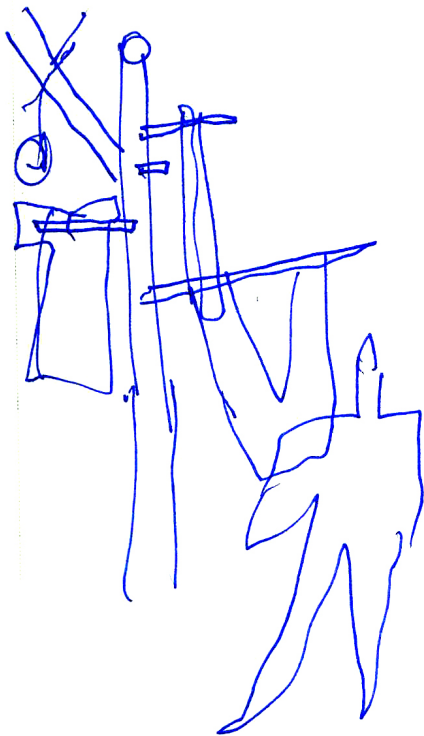

it soundy

NORA JOHNSON?



Fri Oct. 27.

- ? Kaman SUZUKI
- ? Kaman Cosa Toledo
- ? Kaman Cecilia Luis Ruiz
- ? Kaman Hector FE (PFC)
- ? ETSAM. Pepita. Rovo.
- ? Kaman. Alejandro Gomez
- ? toque a Montpellier

? EFE
? texto pag 20.

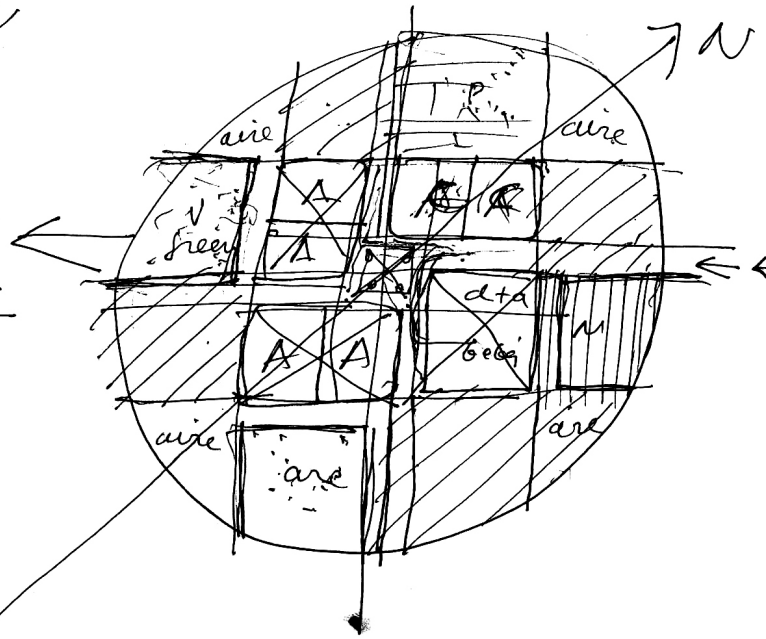
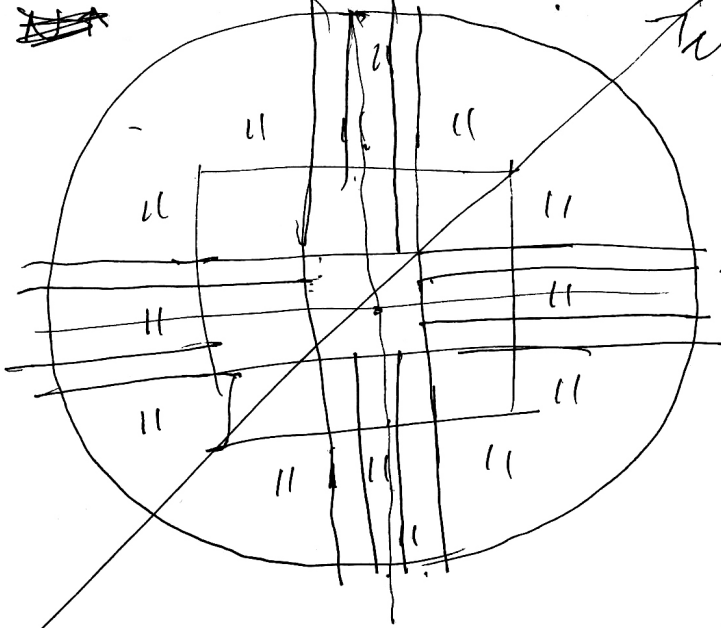

— Estructura triple para cubrir Terraza

, natural

madera clara

madera oscura

blanco

negro

tejo amarillado.

PANES PIZARRA???

(resumen.)

6 reducir el agua

7 eliminar el PÓRTICO de entrada

CASA BARNET

CASA en TOLEDO (reconstrucción)

4 enero 2007

garden

para RUFINO, CONSUELO y RICARDO.

61
1945

CMR RCA

N

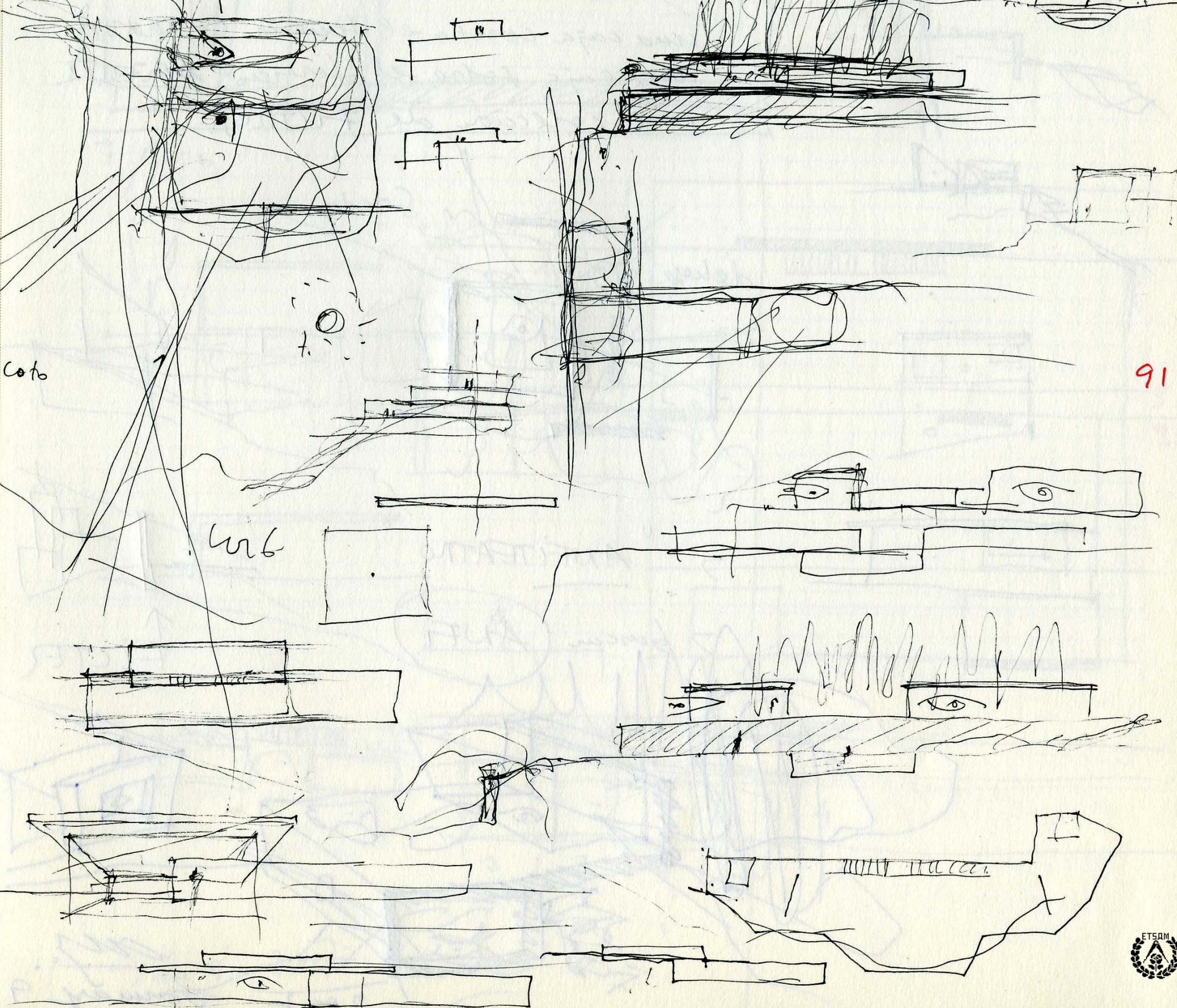

Coto

urb

91

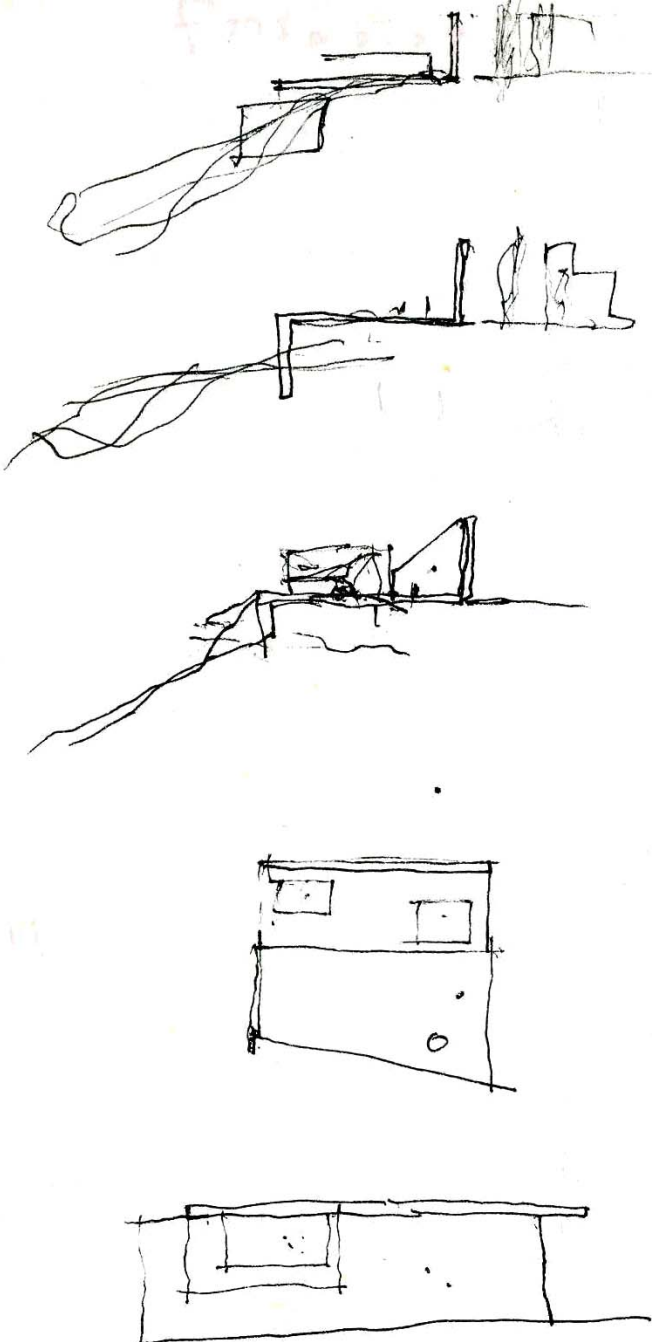

una caja contra el terreno CERRADA
 una caja sobre el terreno ABIERTA
 una colección de FILTROS.

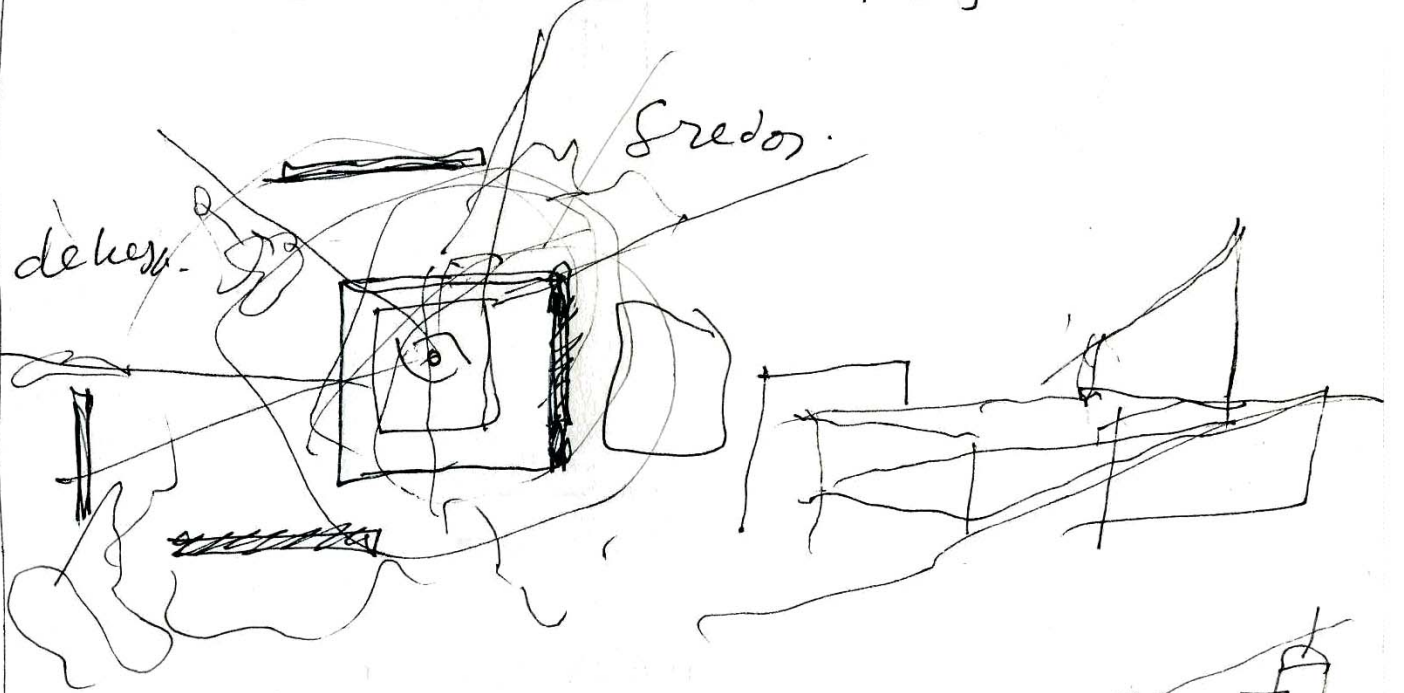

"ANFITEATRO"

buscar ANFI

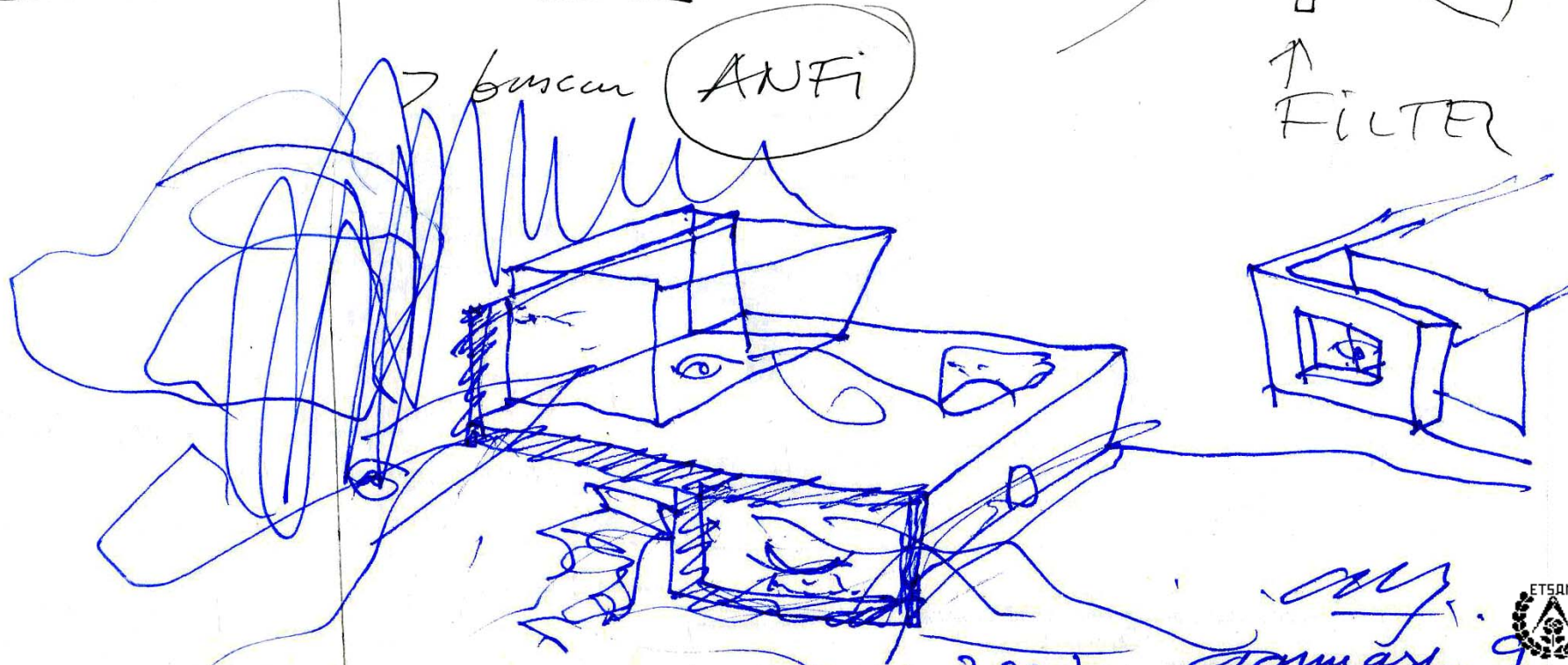
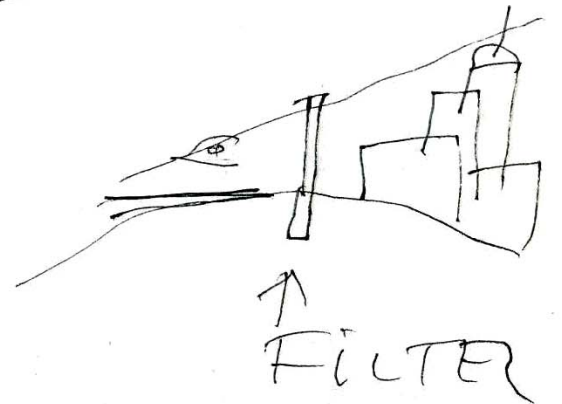

CASA
BARRET

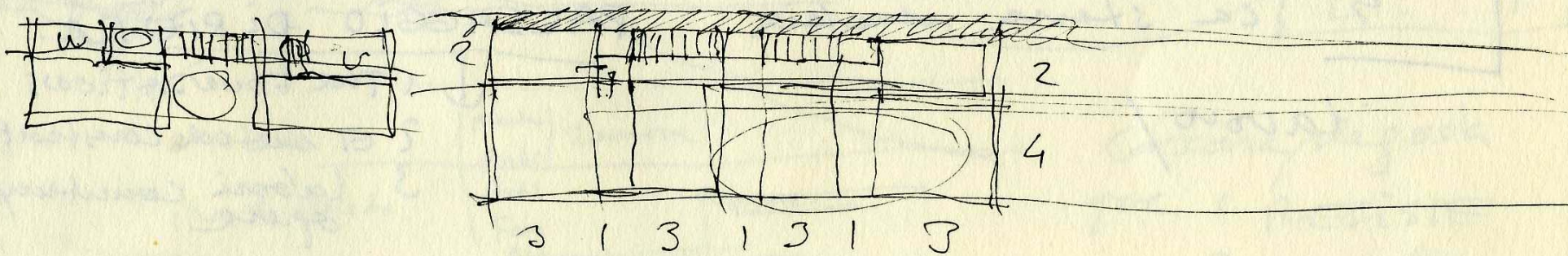
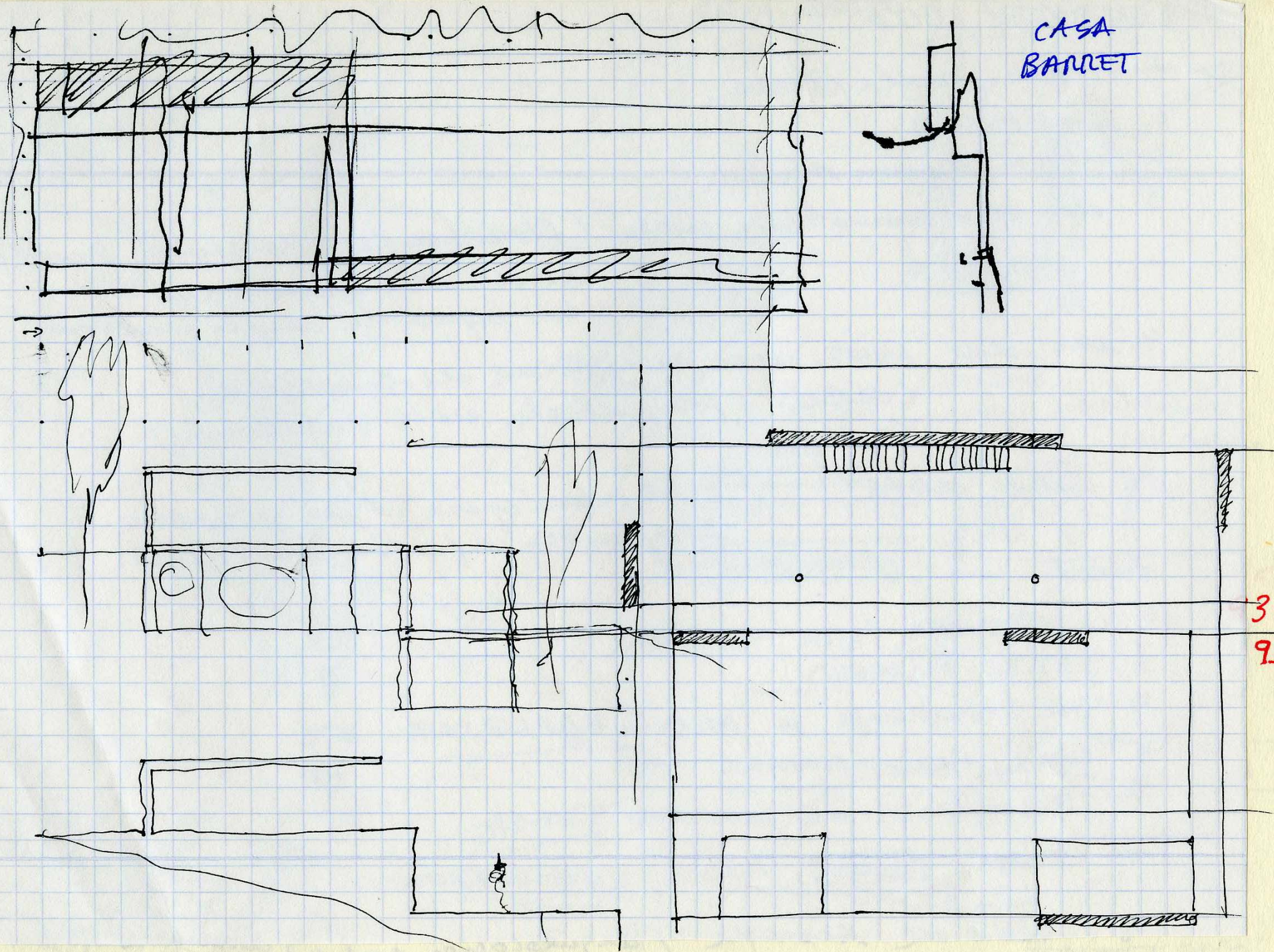

Jan 9. 2007

CASA BARRET

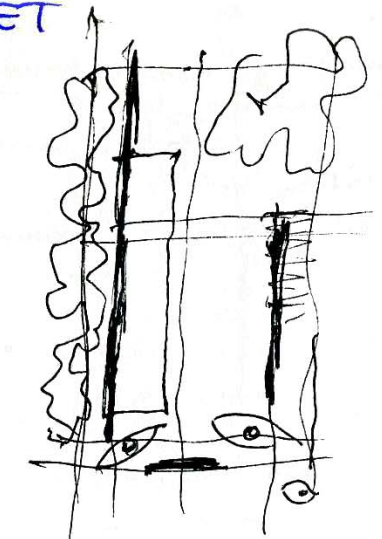
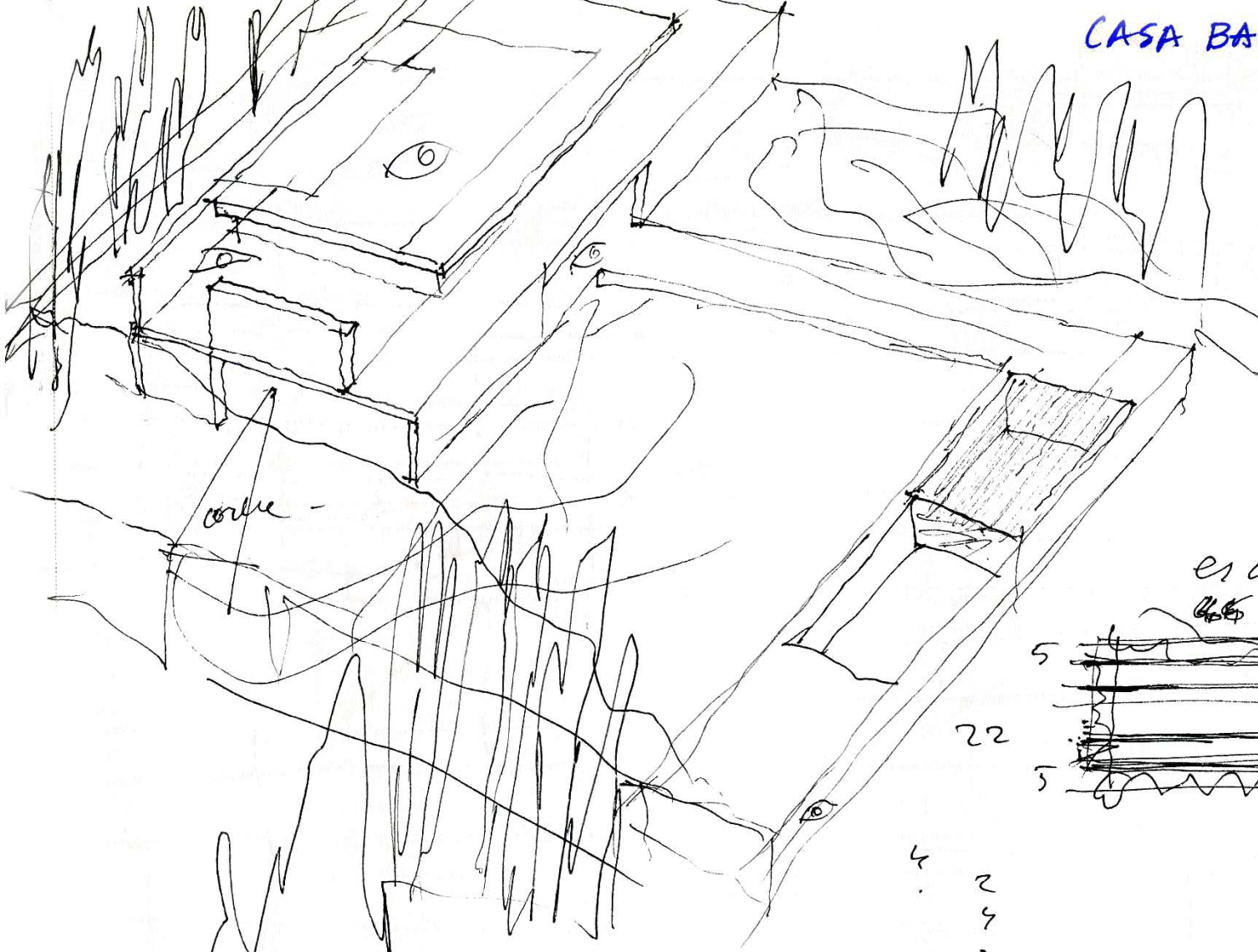

es una (cáscara) envoltura
nueva con forros.

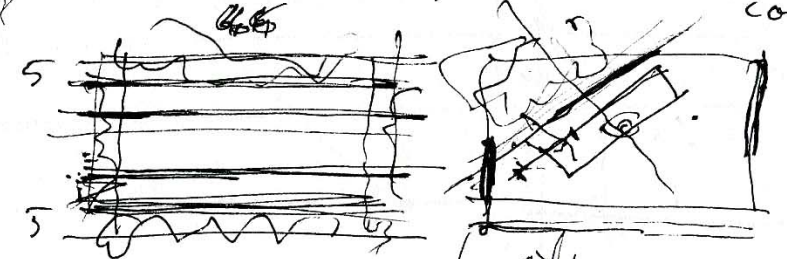

95

132
134
1472

4 2 2
2 4 2
4 4
A 2.

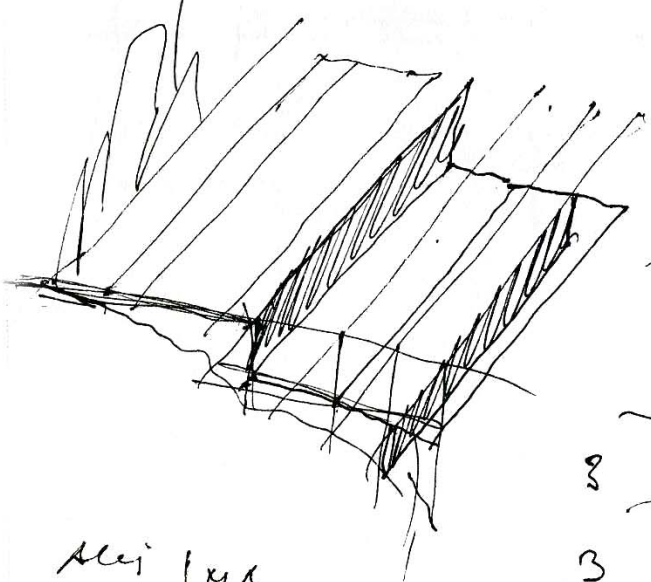

20
17

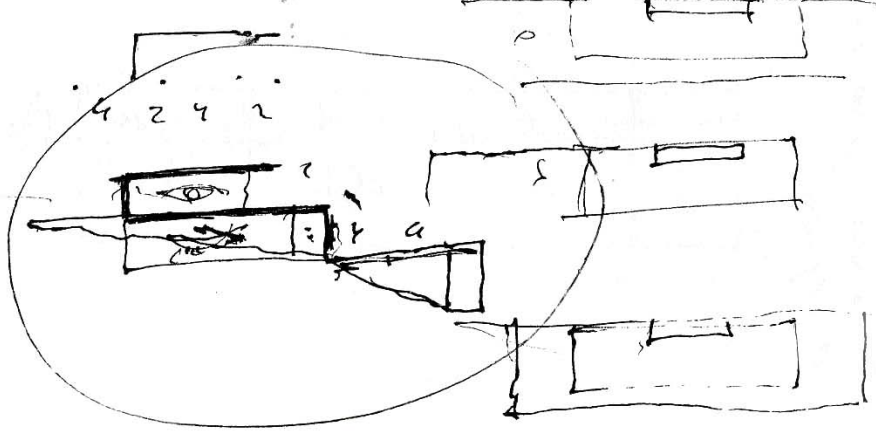
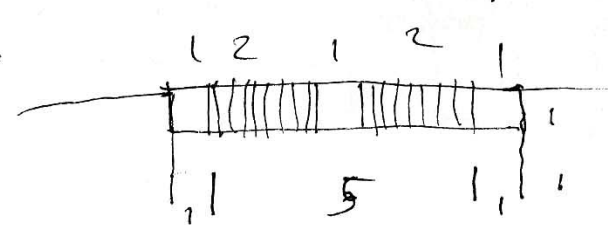

Alej	MA	Nacho	toledo.
Nacho	EC	Nacho	fuav.
	Za		
Guig	olivia	Pero?	
Nacho		Peter?	orden.
Joa			
Nacho	MI		

Nacho ramora
Pabl
Pabl.
Fian
Alt

Cáscara legada
que RESISTE
2 ENFOCA
VISTAS



Montevideo
Jan 14, 2007.

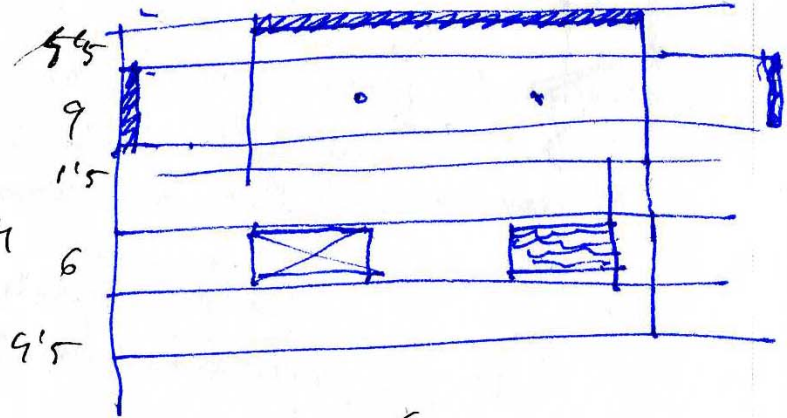
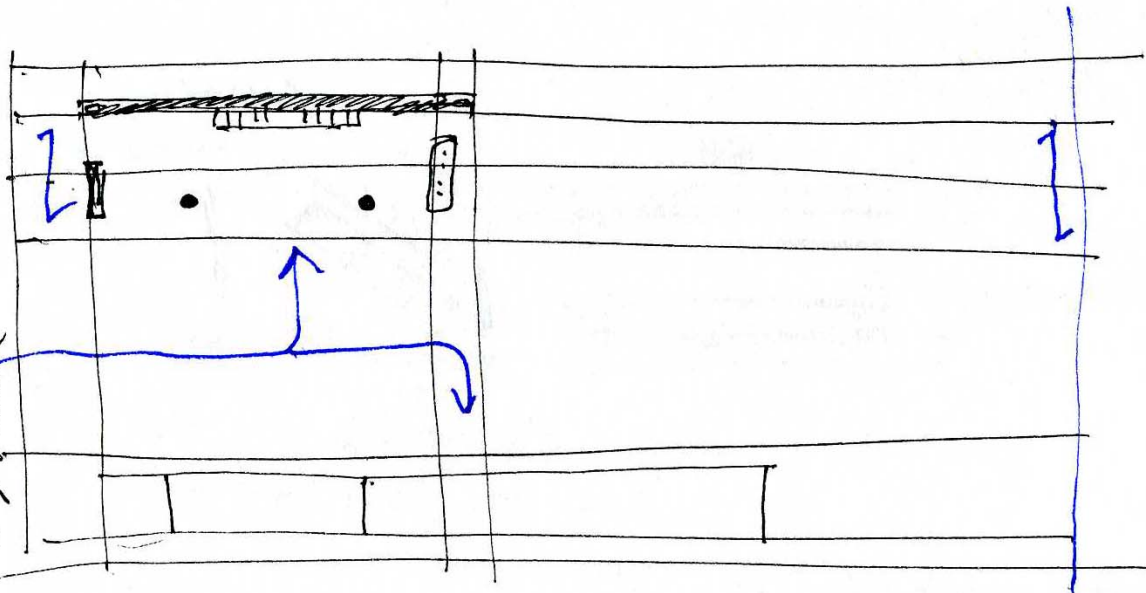
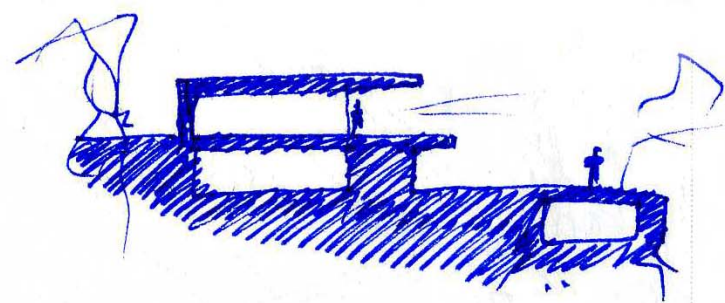
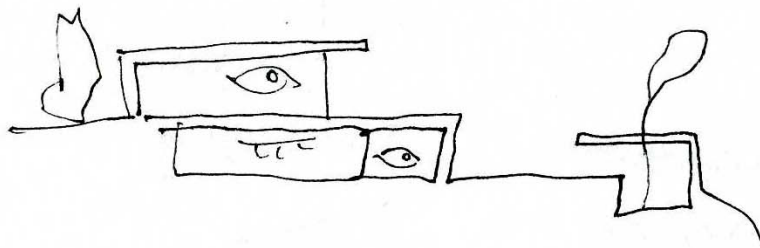
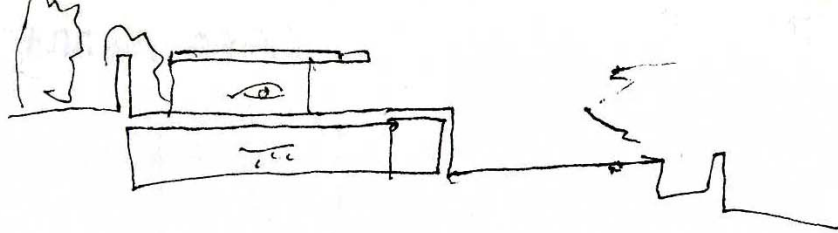

62

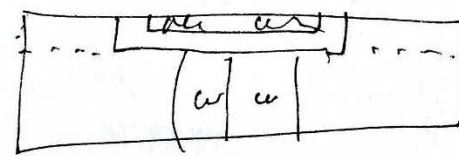
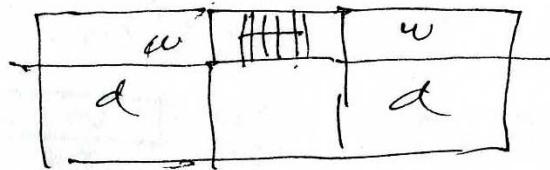
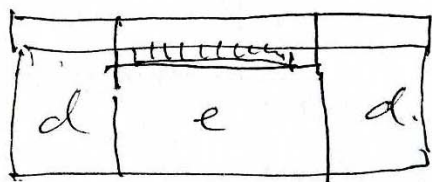
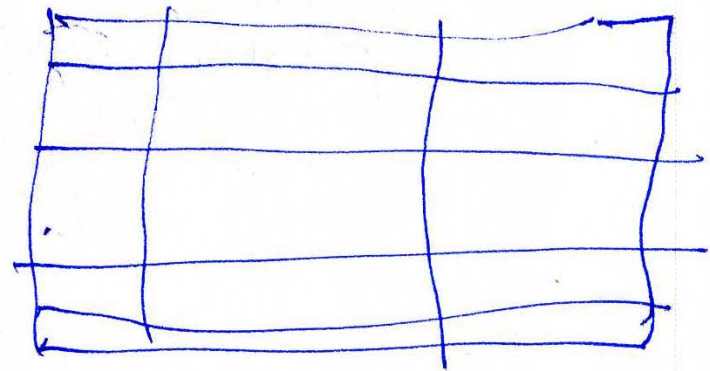

Casa para Rufino, Camacho, and Delgado

Fernando Ron / Carlos A. Perri (actuales si)
No. P. Alvariz 17 enero 2007.

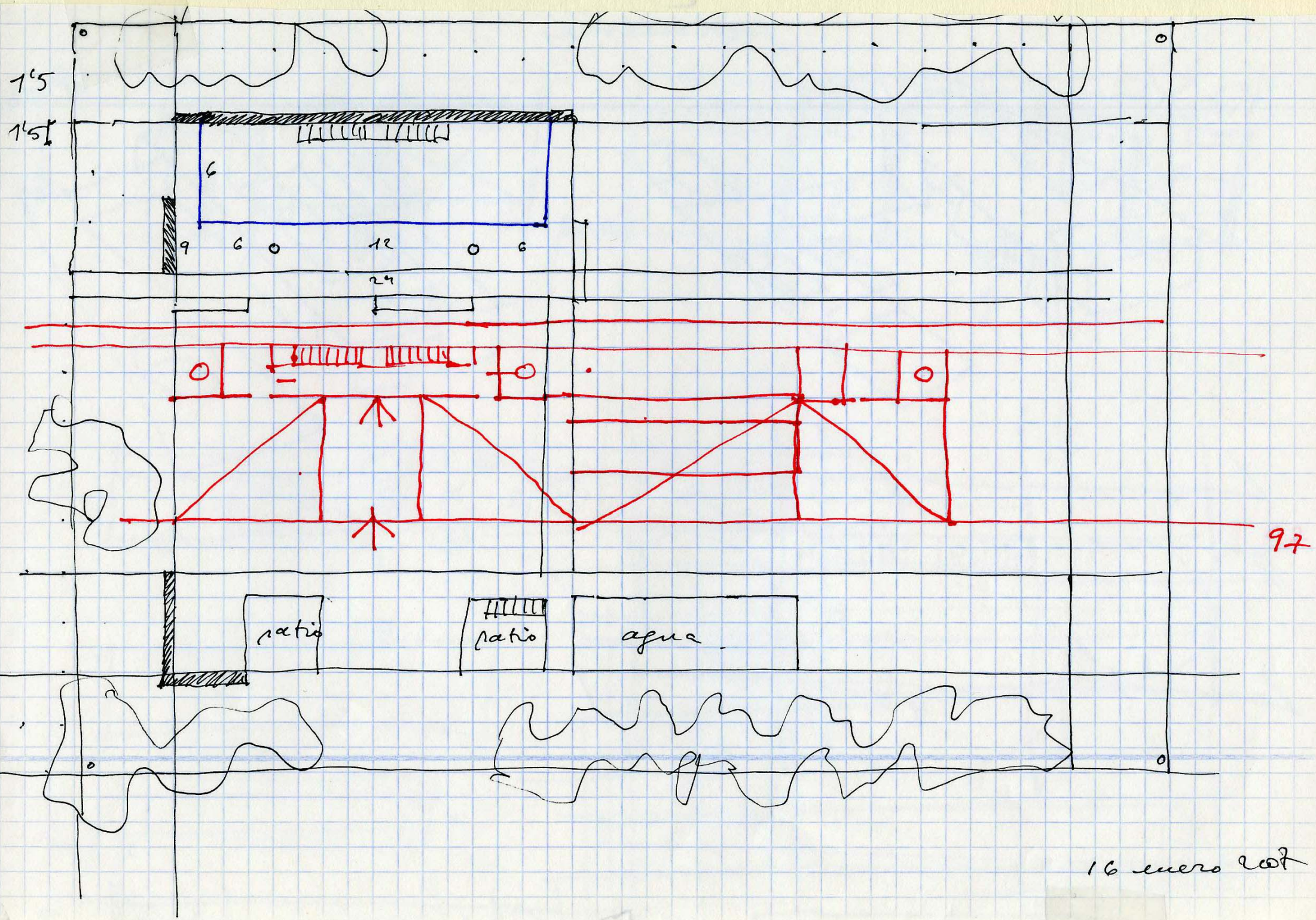

16 enero 2007

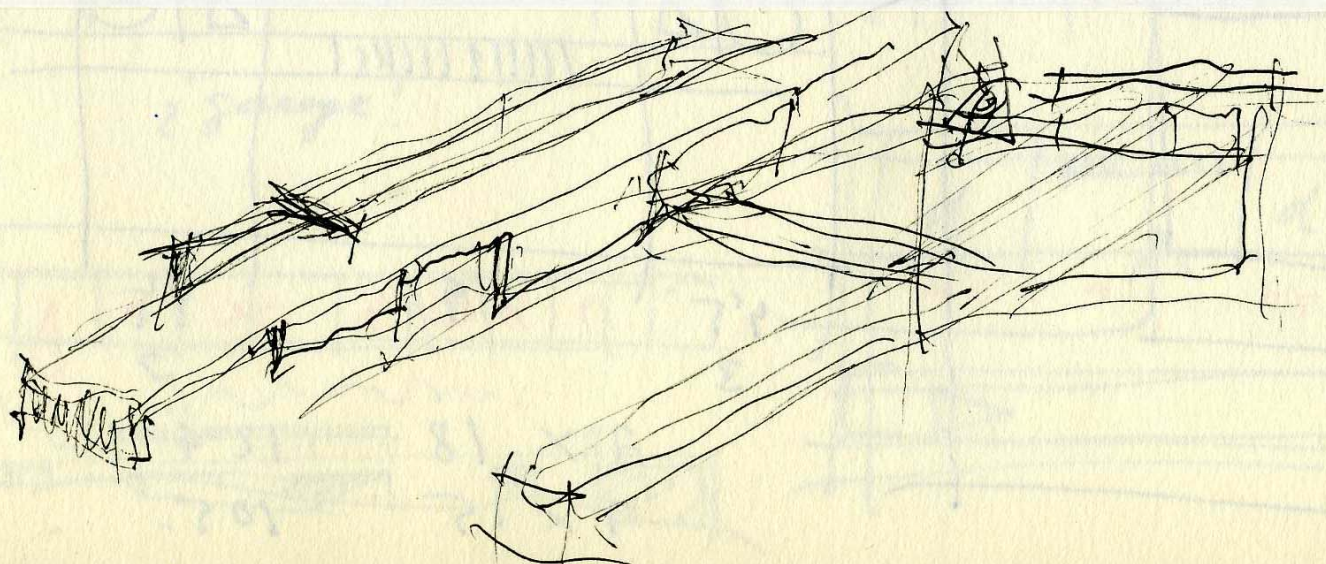

2
possibilities

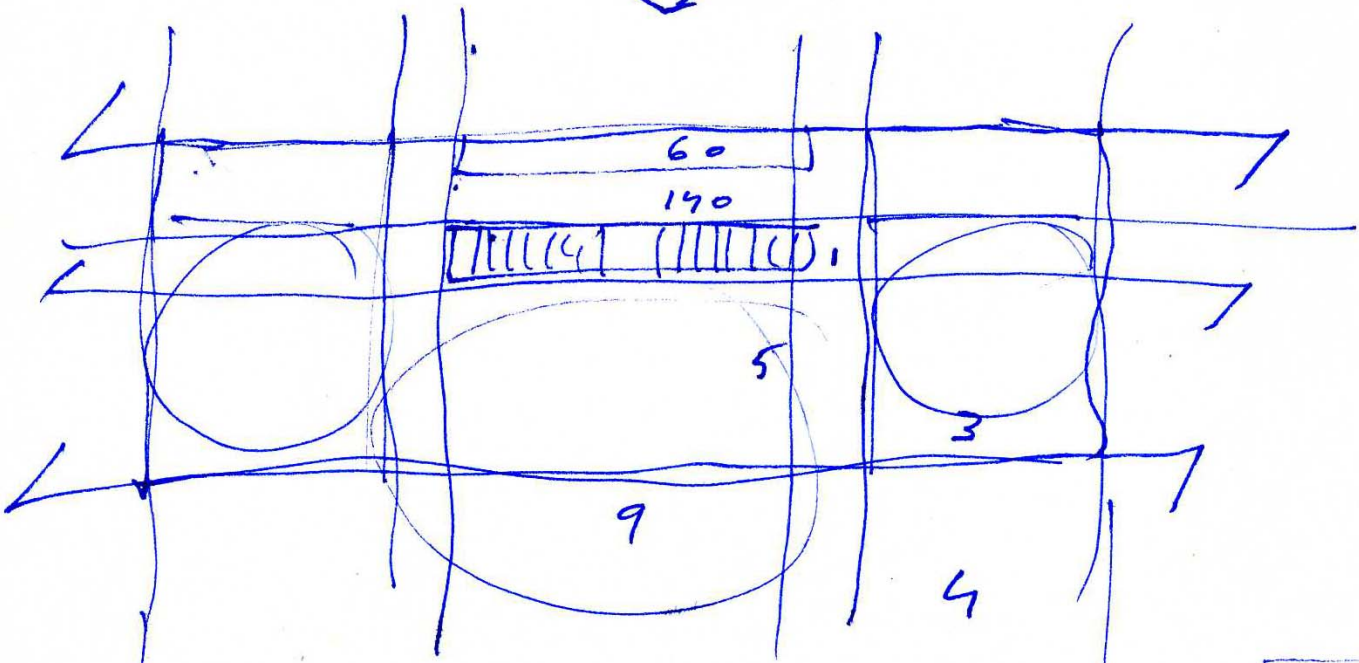
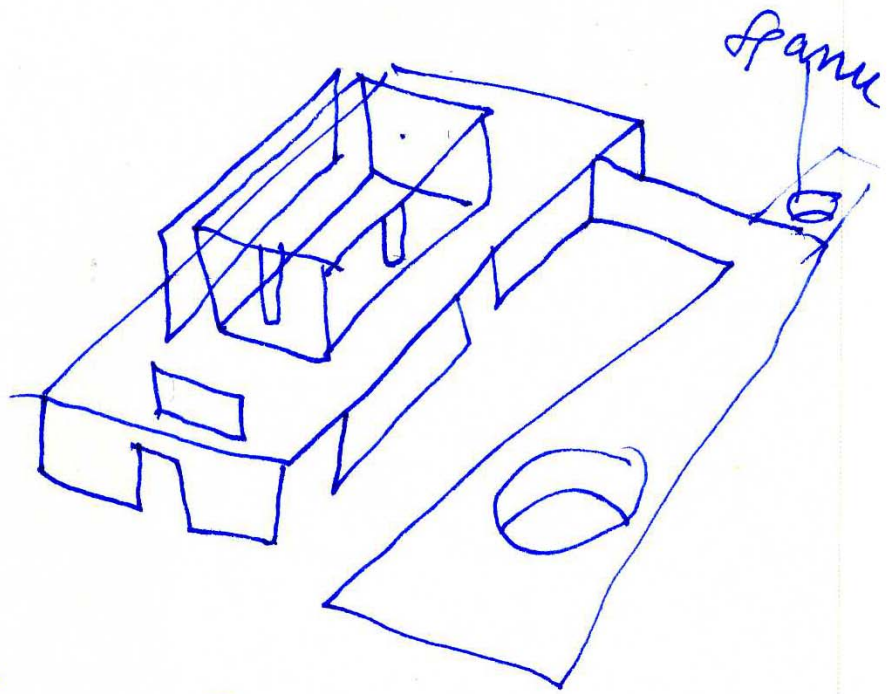
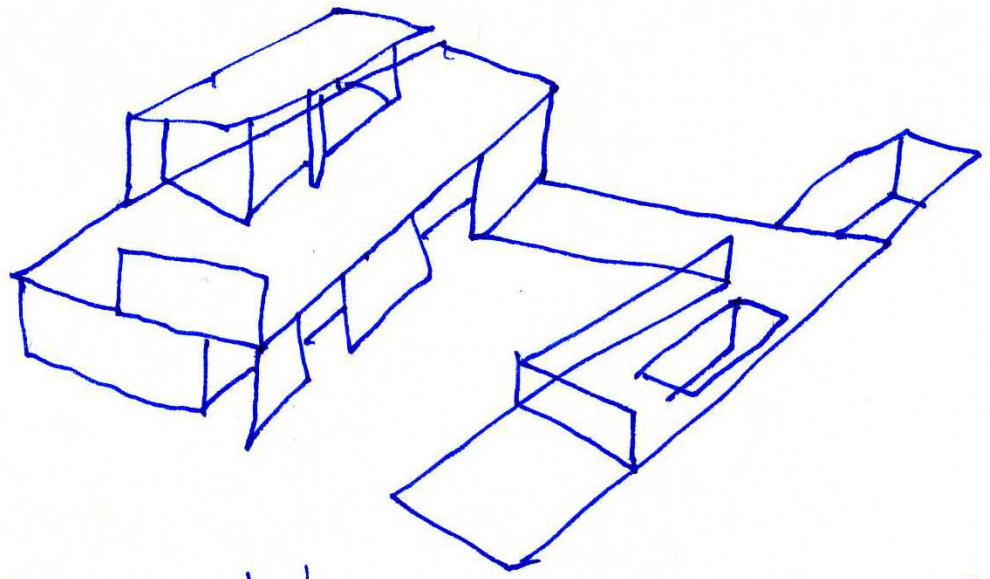

2
1
5

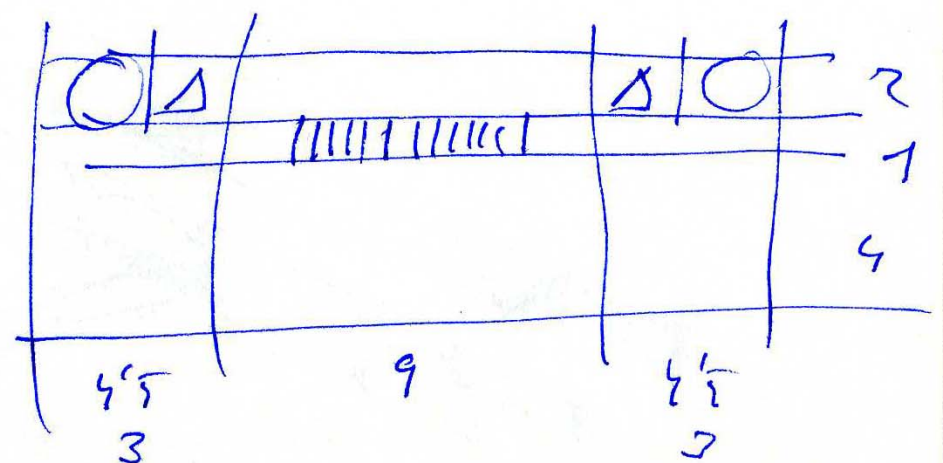
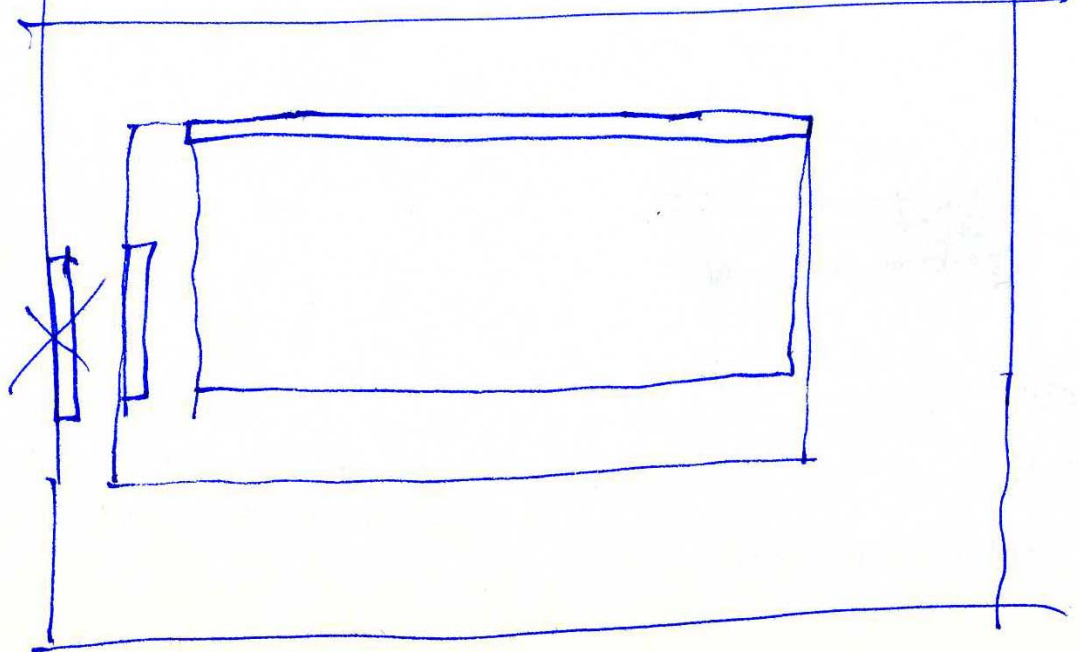

2 x 18
7 x 15
12 6
105.

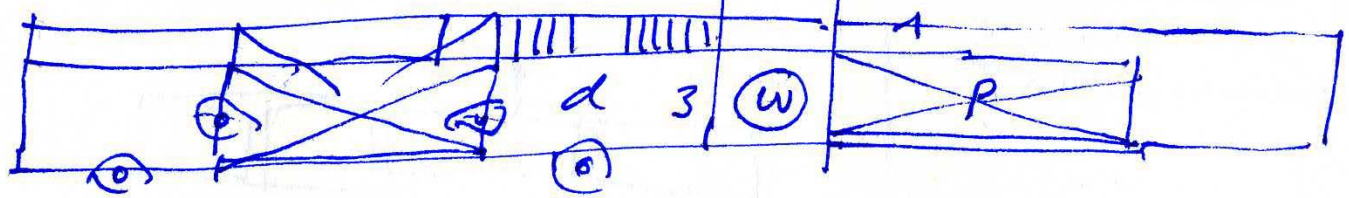
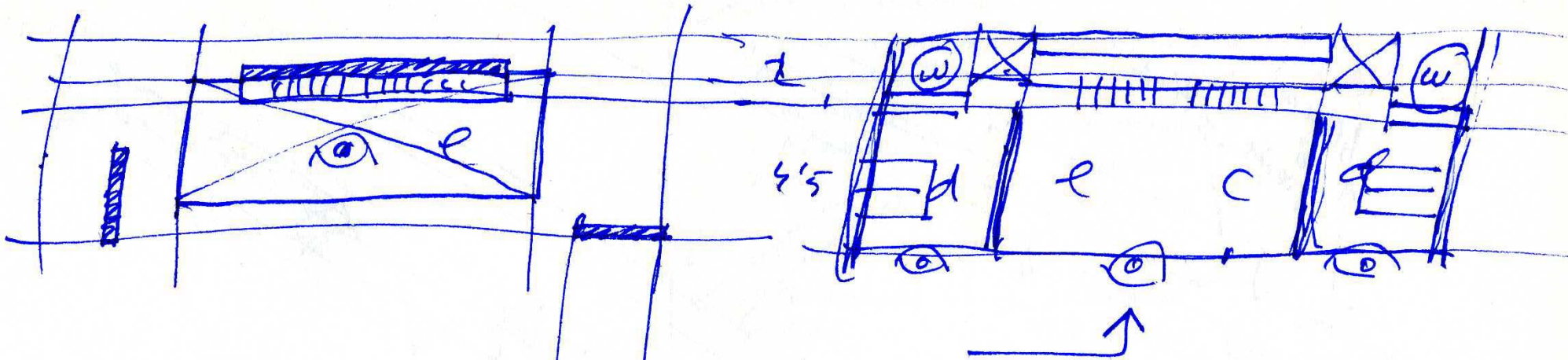

99

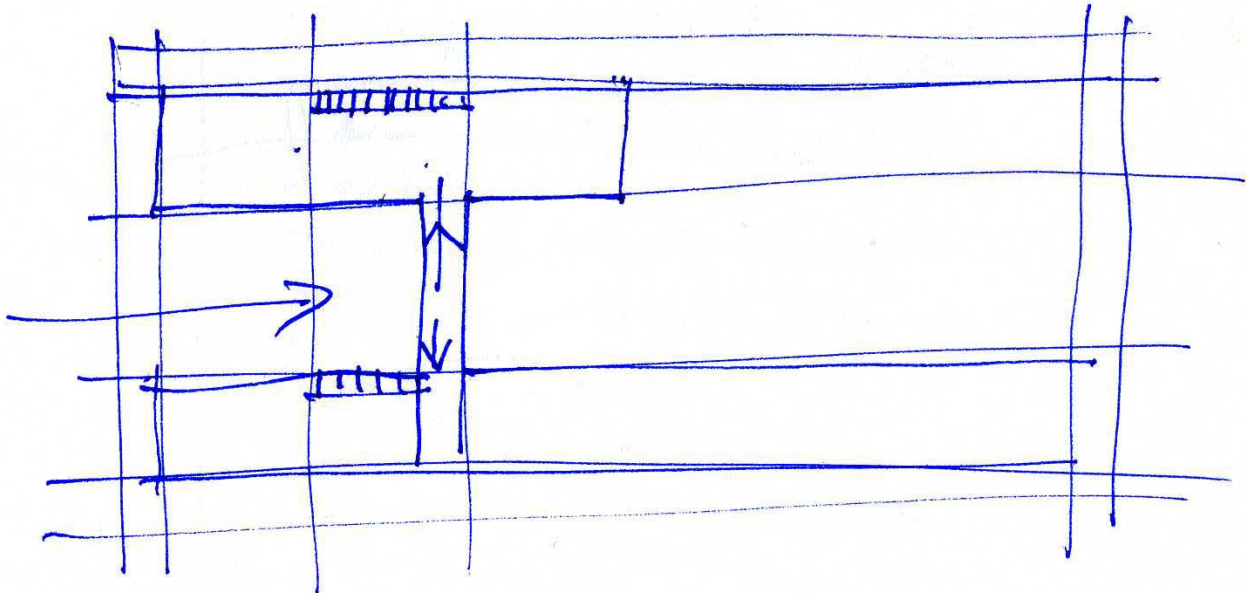
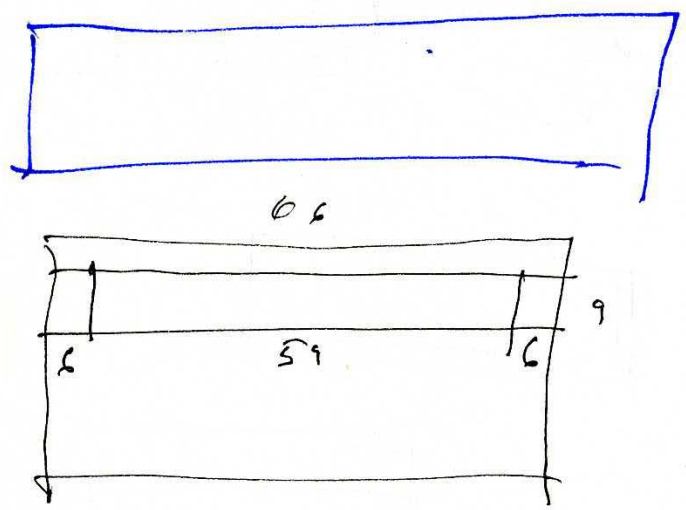

2 garage?

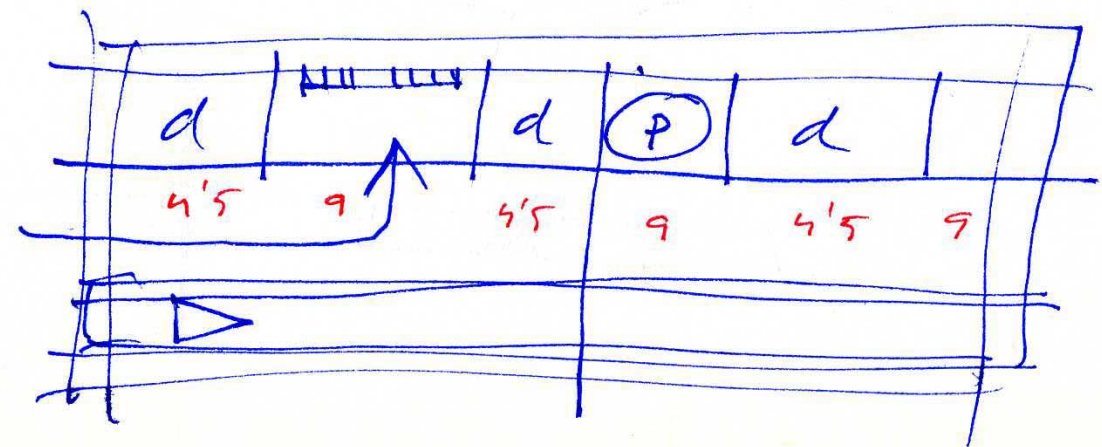
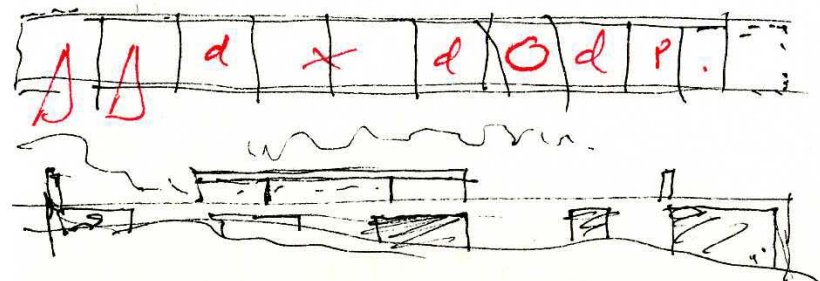

9 9 2
9 1
6

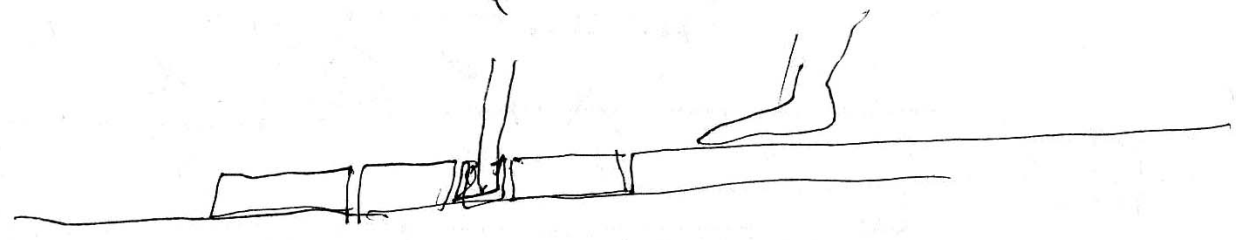
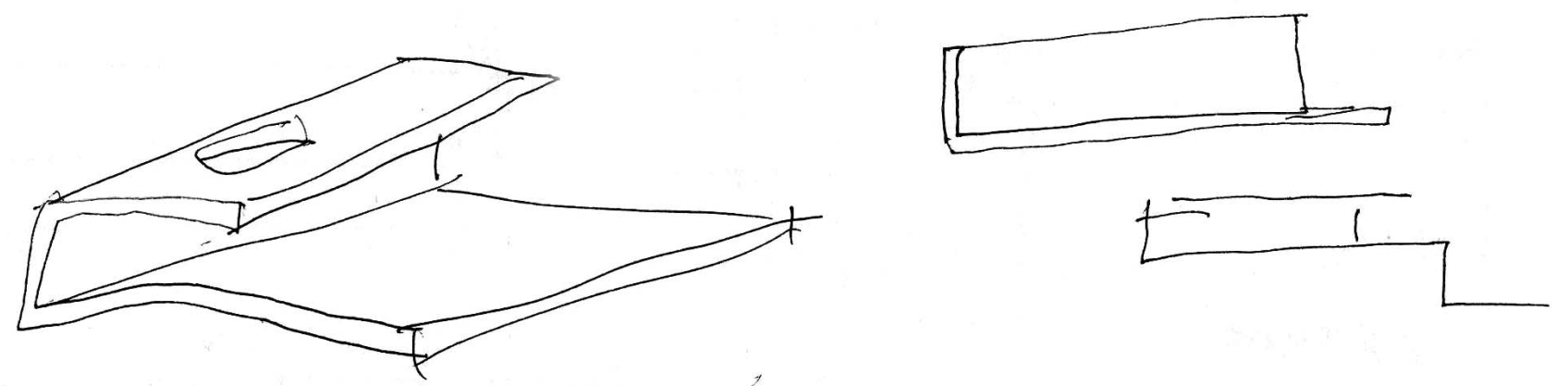
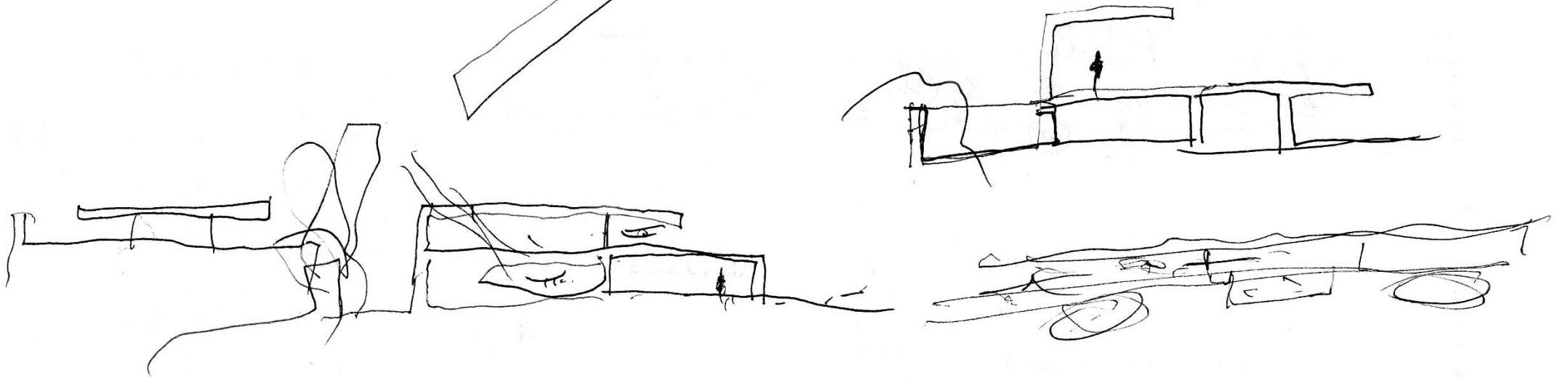
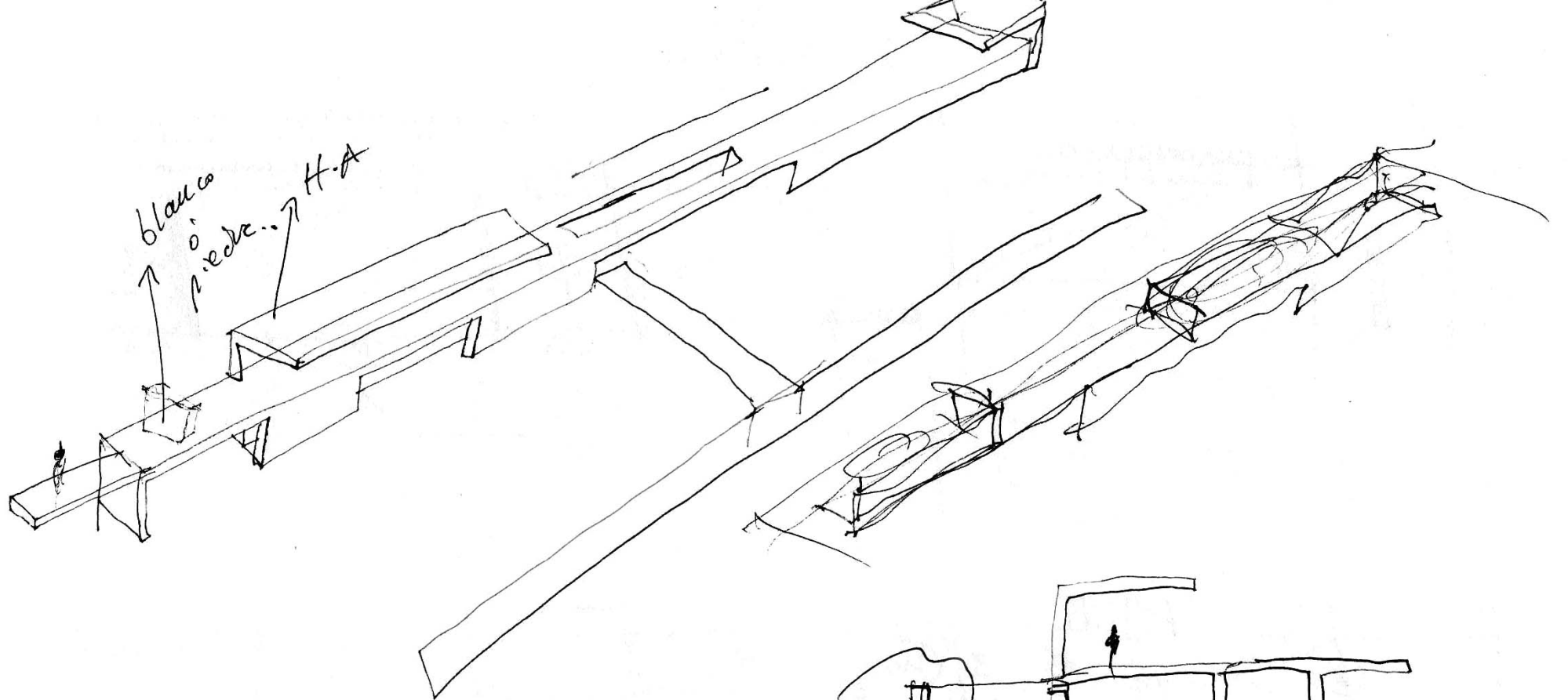

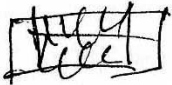
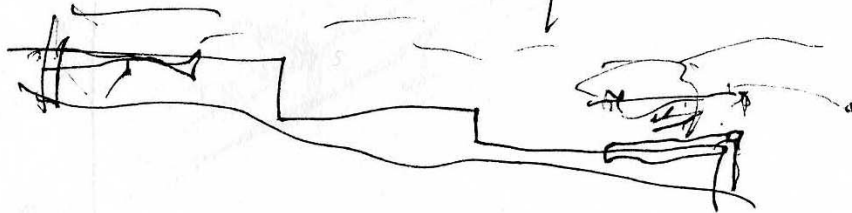
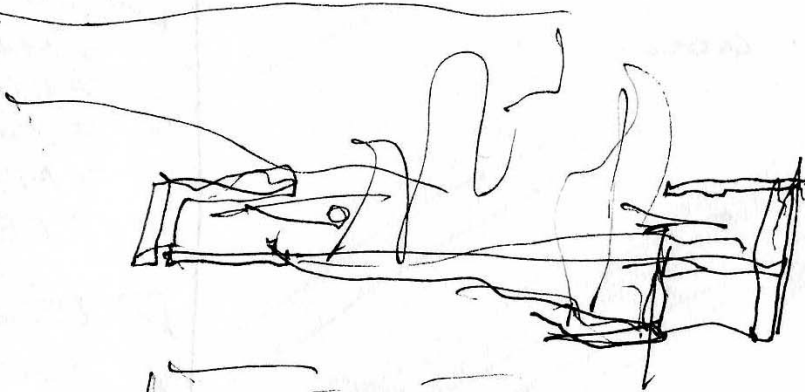
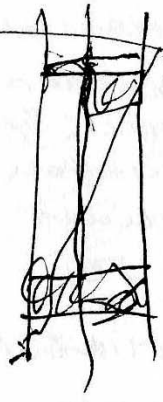
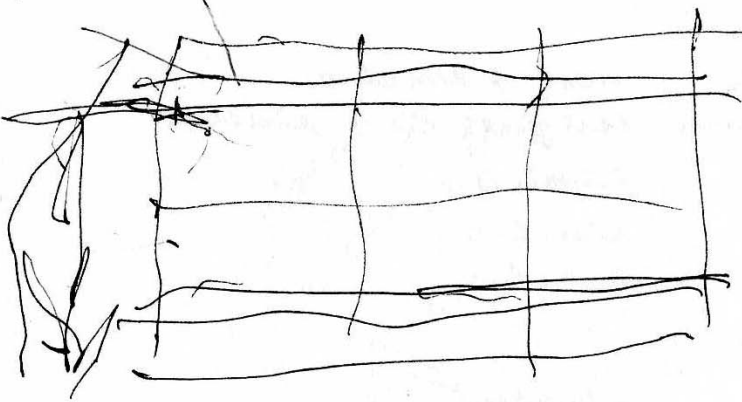

part a

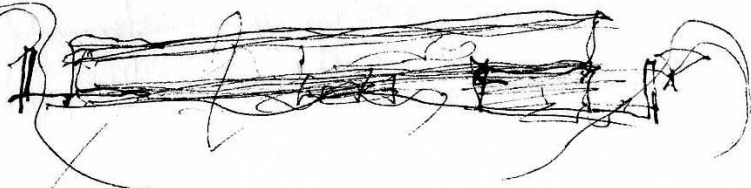
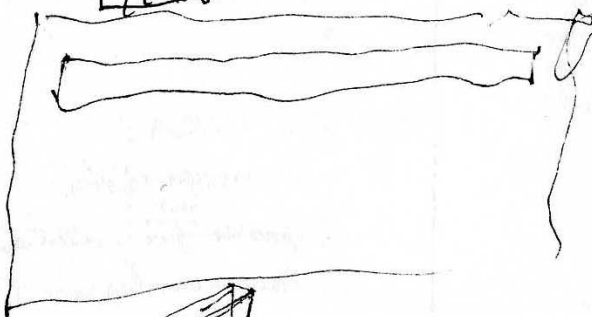
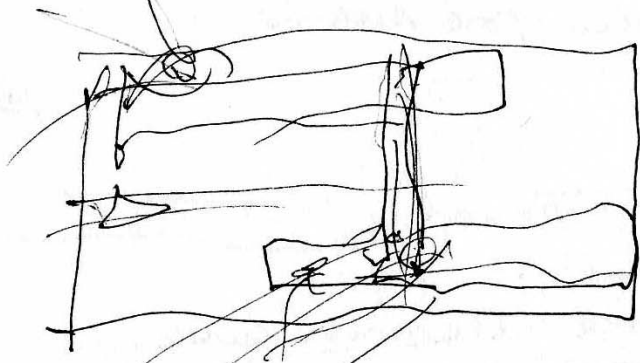

22 22

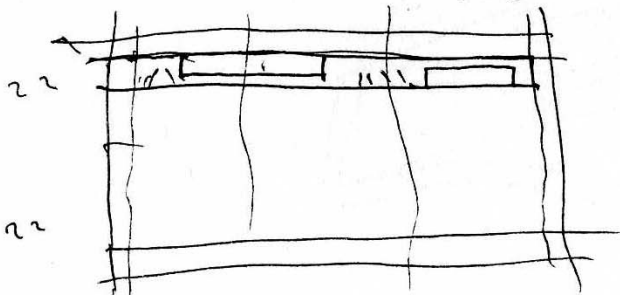
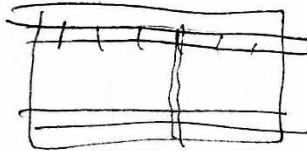
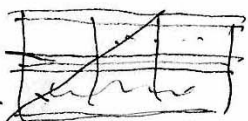
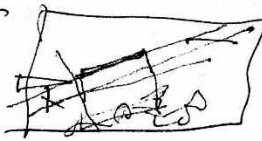
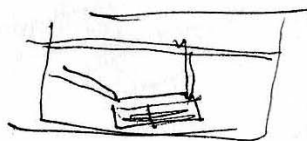
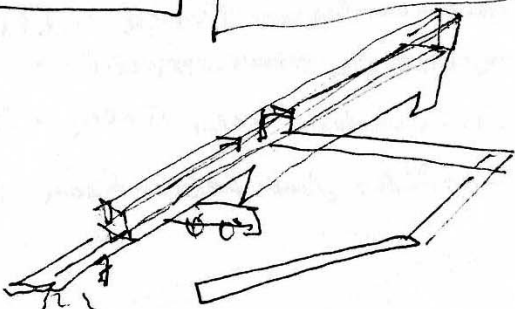

22

22

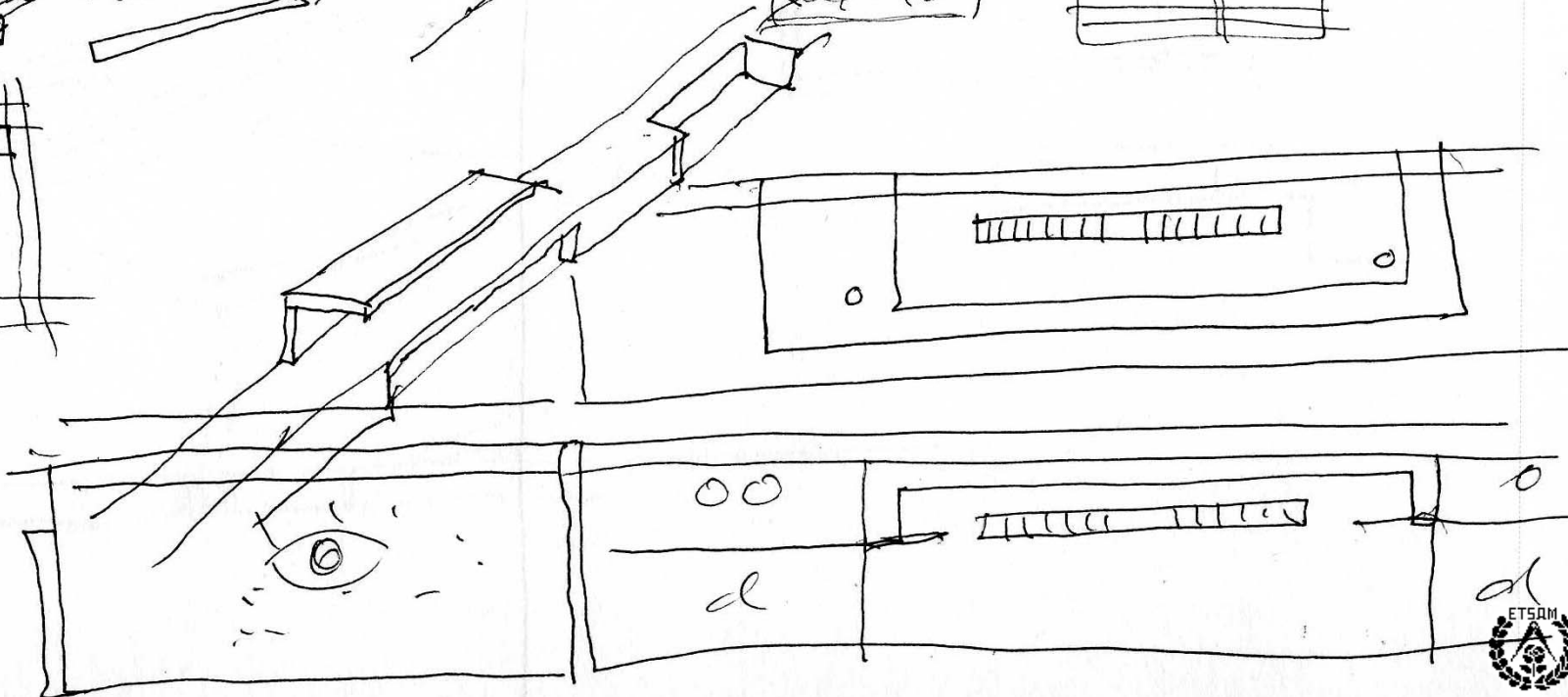

oo

d

d



26 enero 2007 en Cádiz.

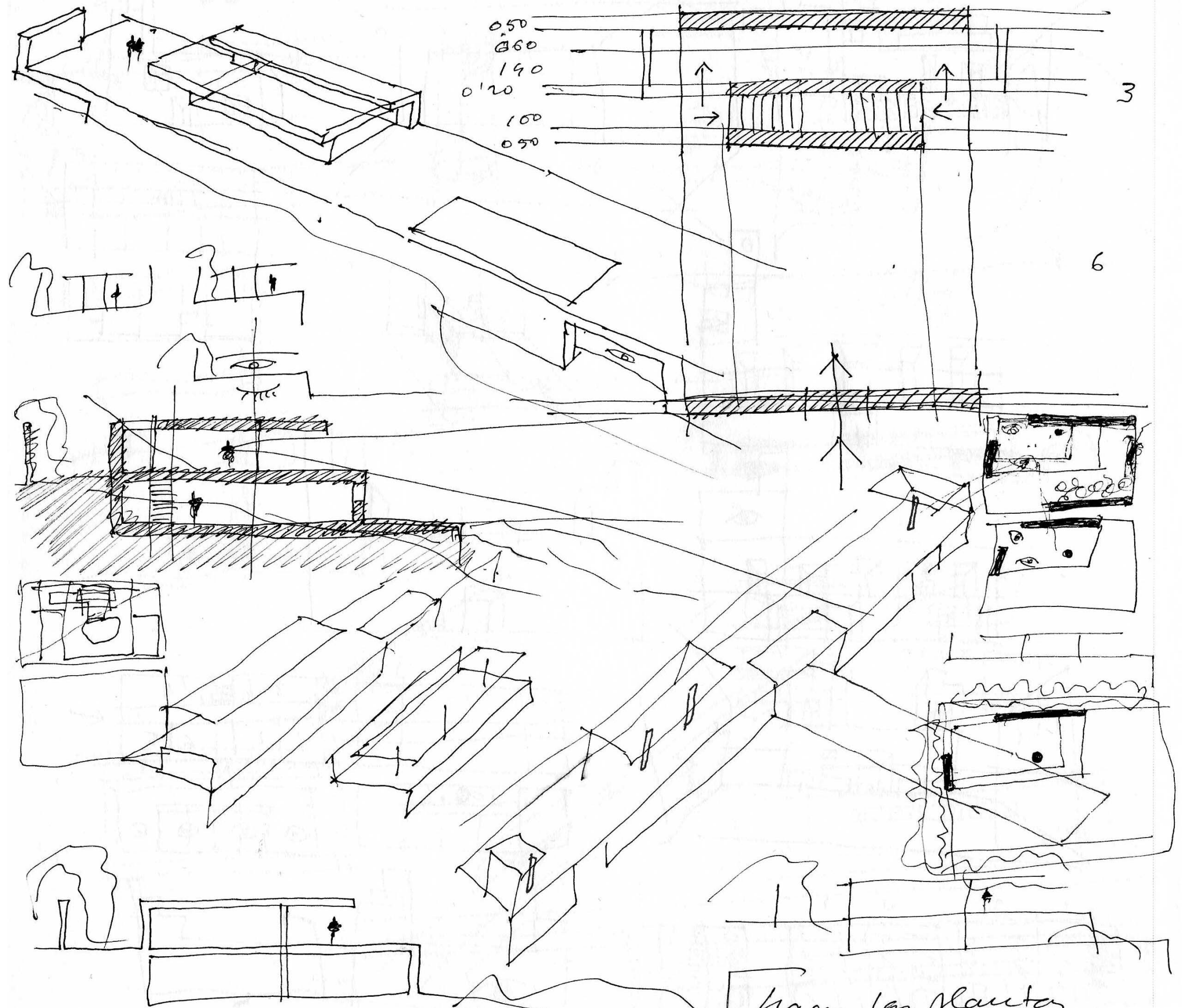

Hacer las plantas
comparadas de
TODAS las casas.

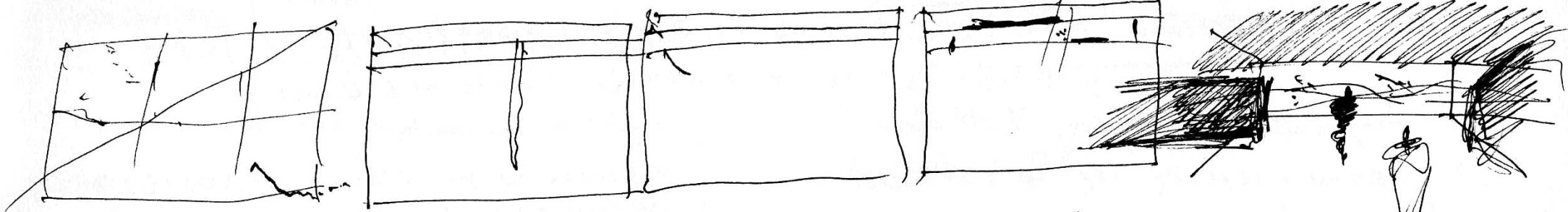

S

texto ETSAM
texto MEIER
texto ACOCEIA

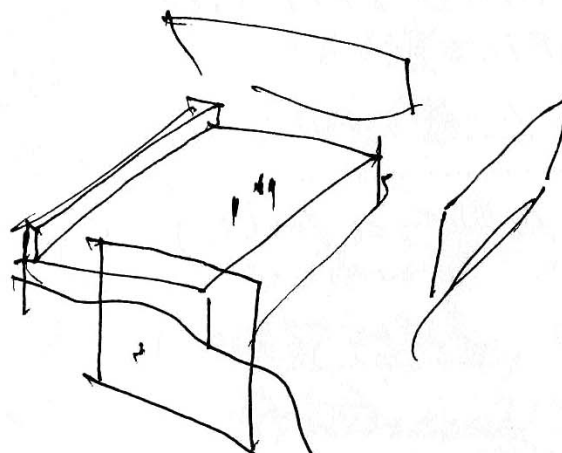
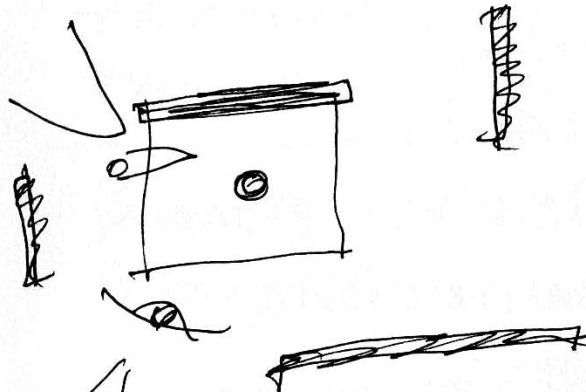

MOUNER
BANQUET

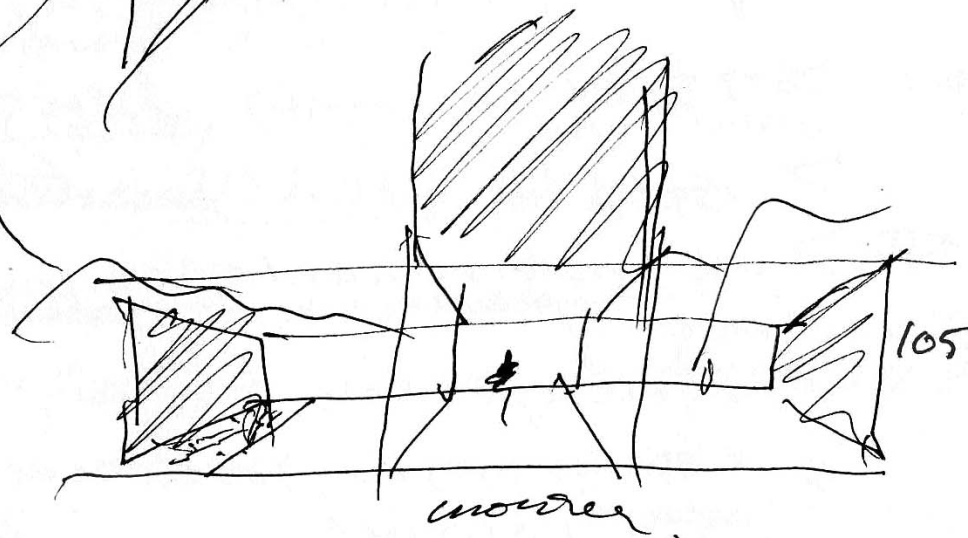

105

unorder

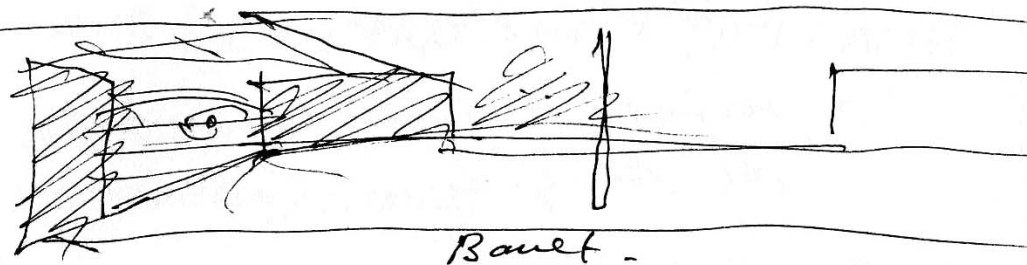
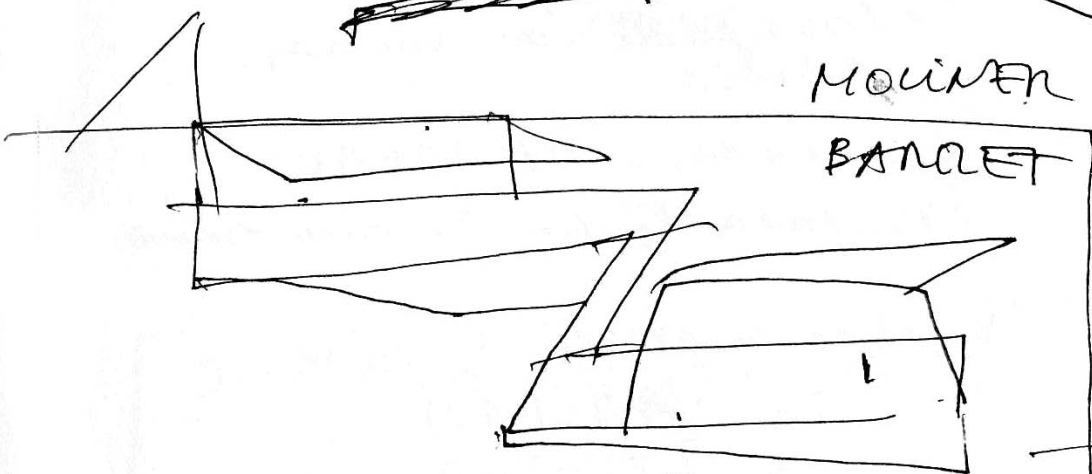

Banquet

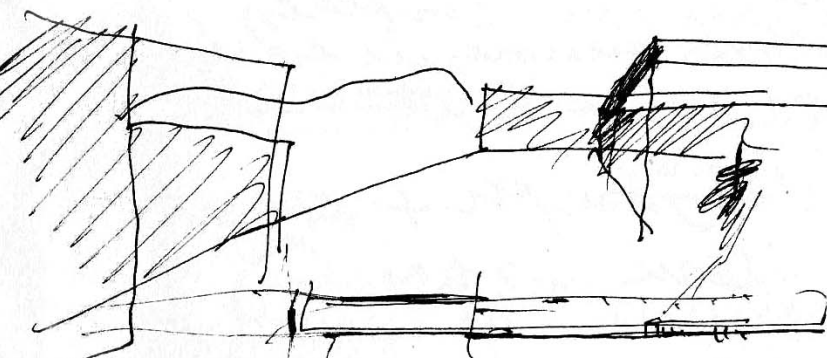
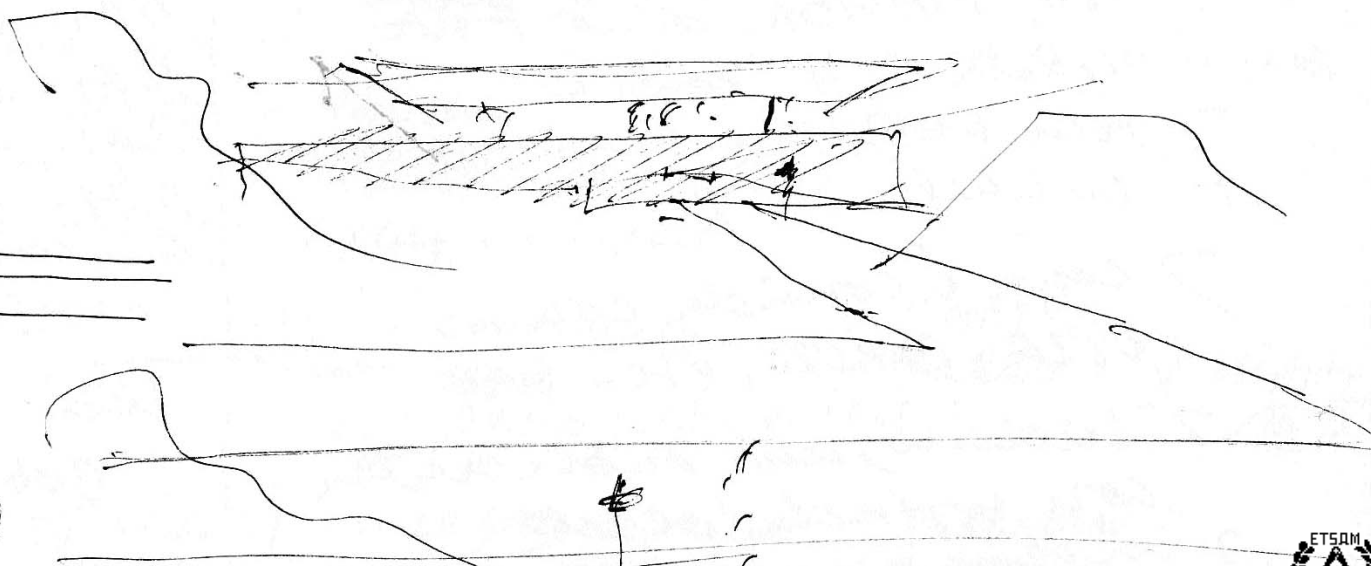
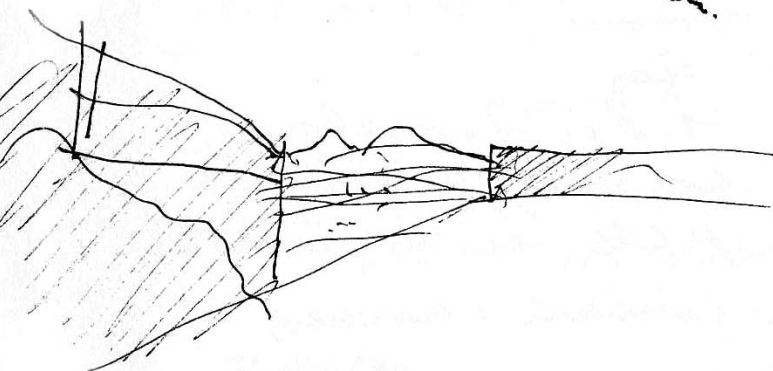

26 enero 2007 en Cádiz.



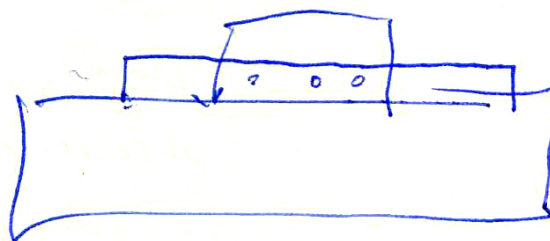
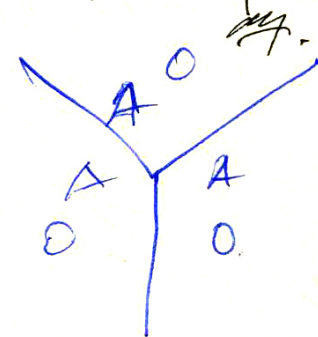
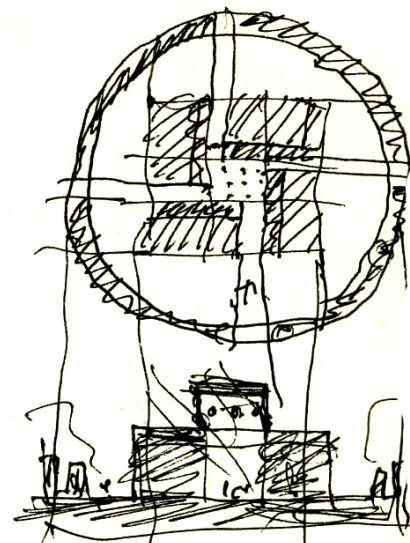
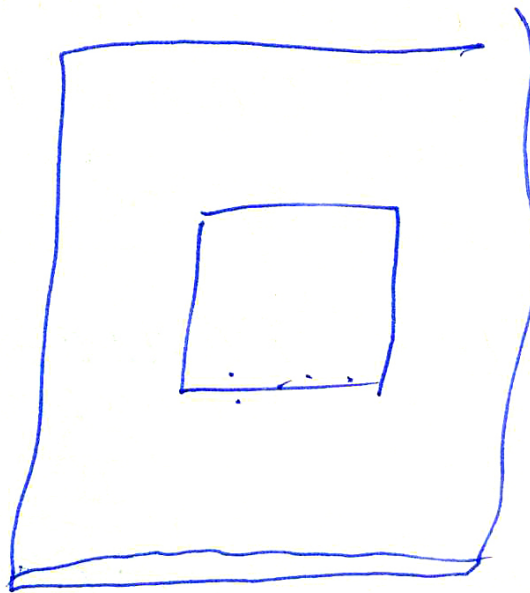
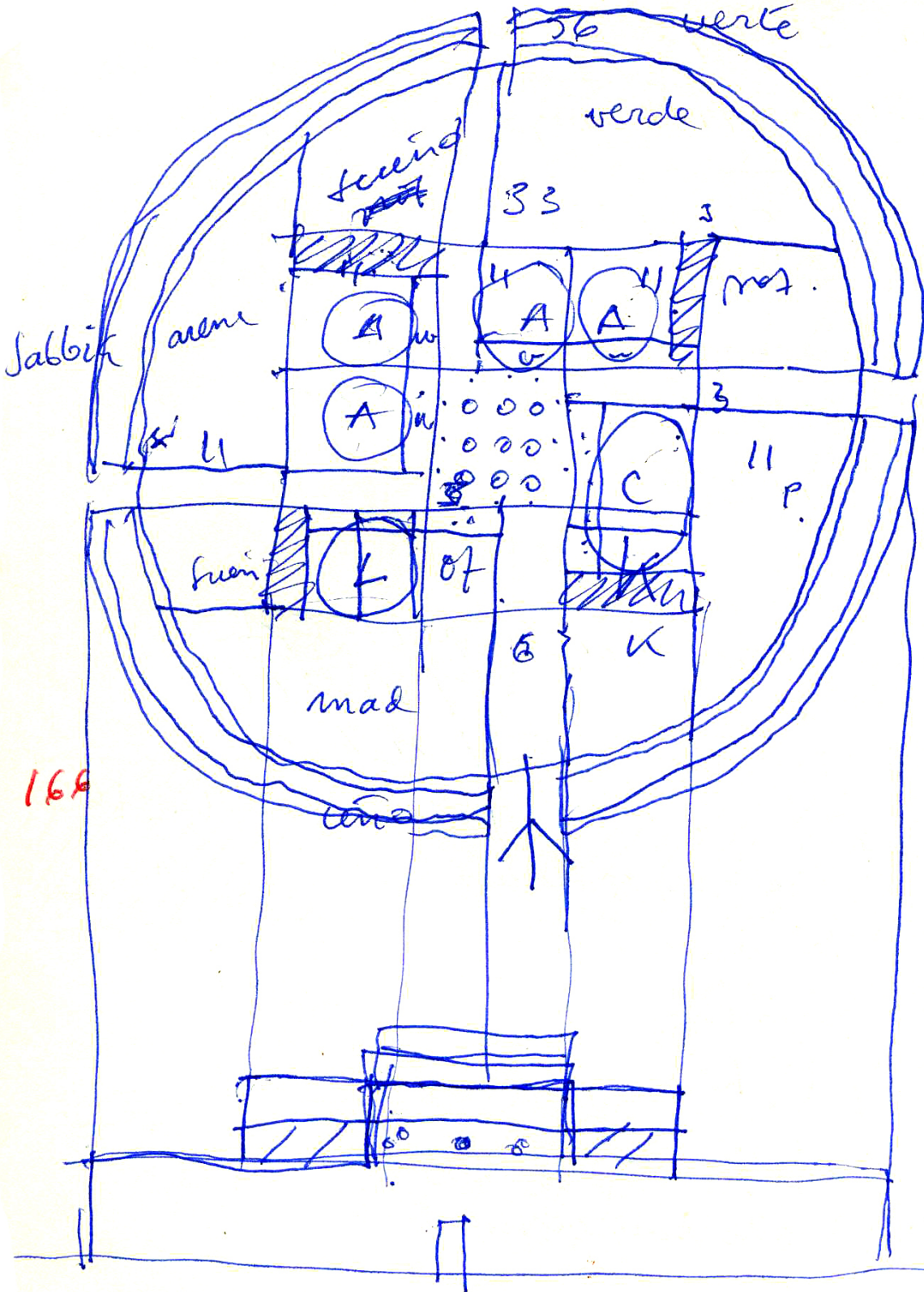

- Turner & M., clifp.
- portugués
- Ulaguini
- Saucio.

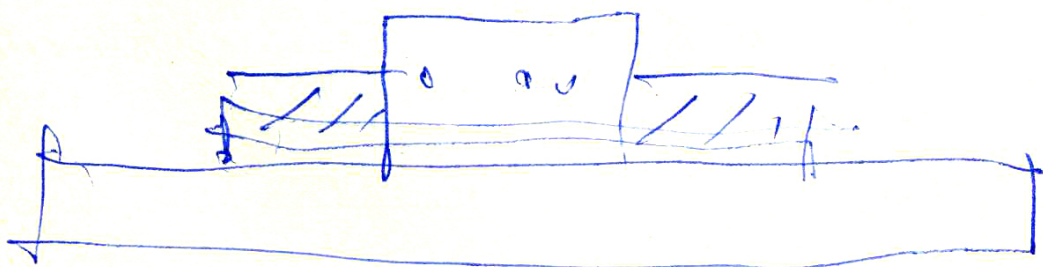

Domingo 13. martes 15 fiesta

- 7 pupé.
- 7 Gabriel
- 7 Carnaval
- 7 ávila
- 7 MB.
- 7 Alberto M.
- 7 Teresa Suro.
- 7 texto RM
- 7 Jodidio
- 7 DIF con festa!

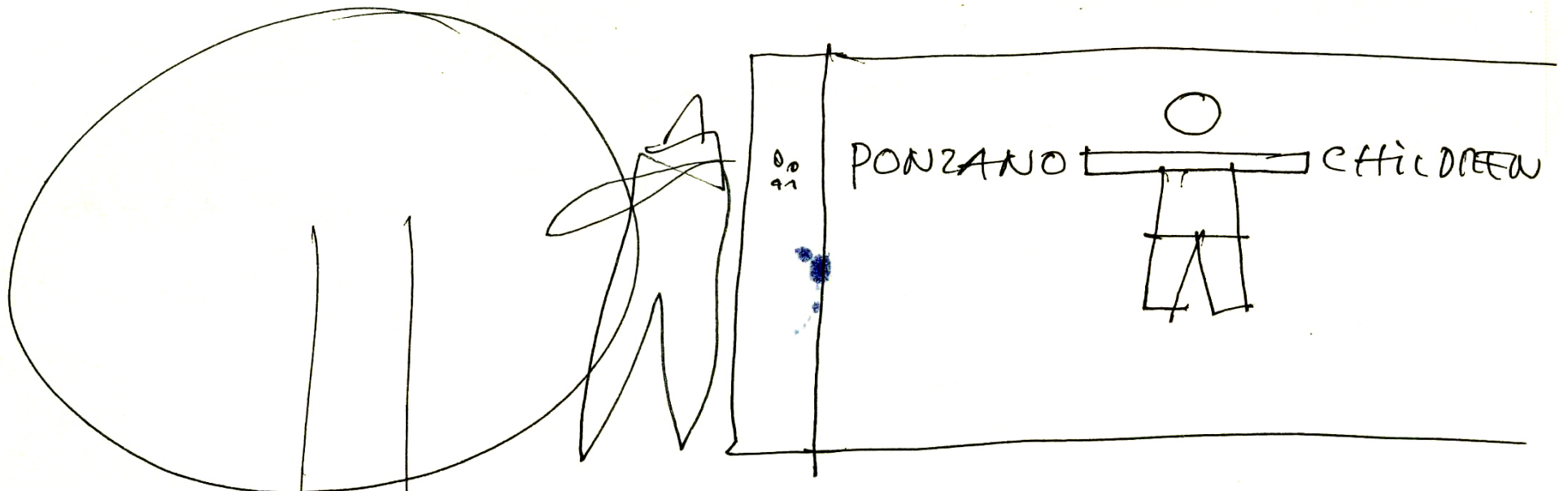

↑
panel de
altura
a la entrada

