

DIO

P40

DECEMBER 2  
2010

100 hojas 21 x 29,7 cm. Ref. 040-0254

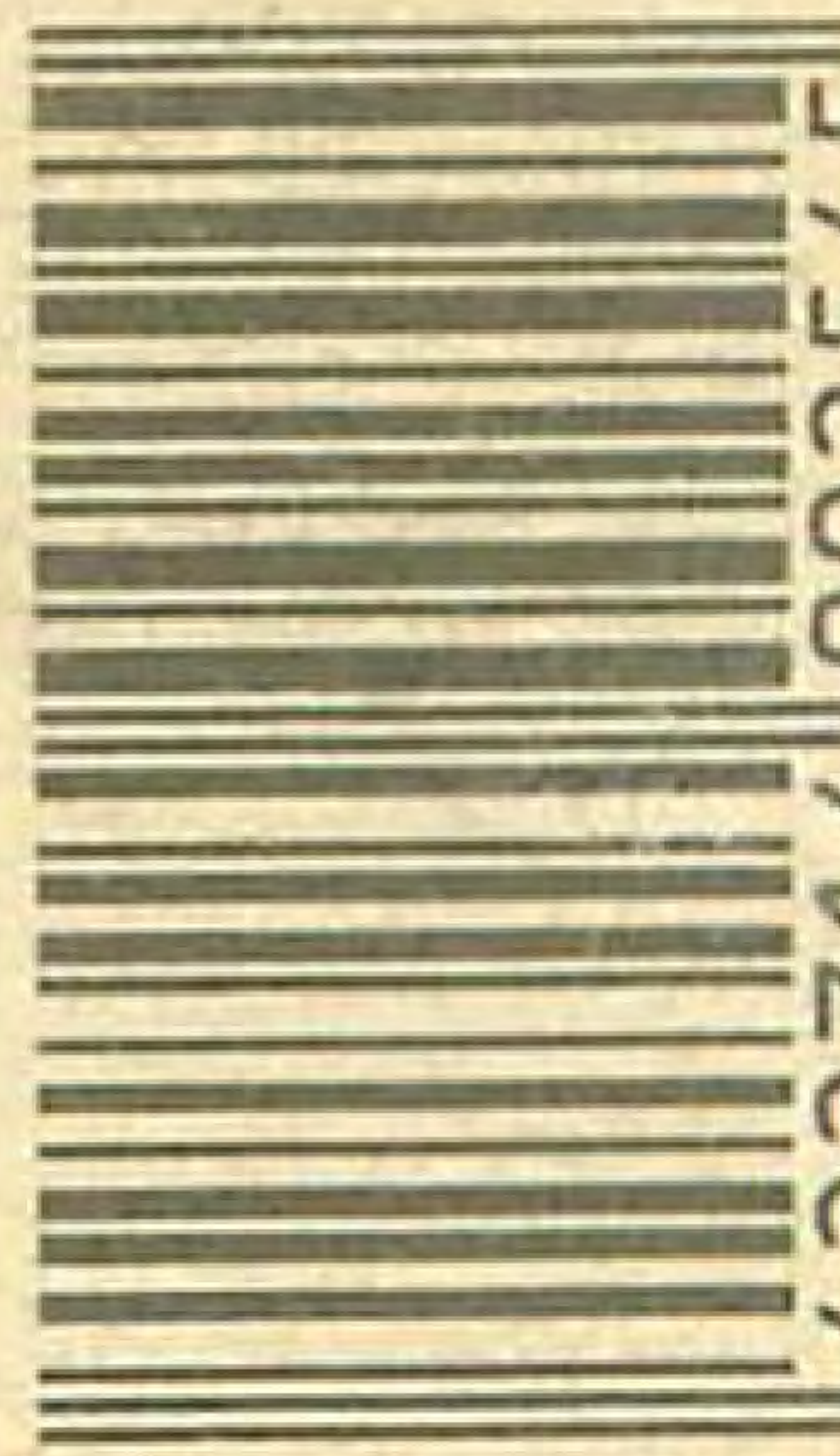

8 422714 002545

RRO

M005

December 6

2010

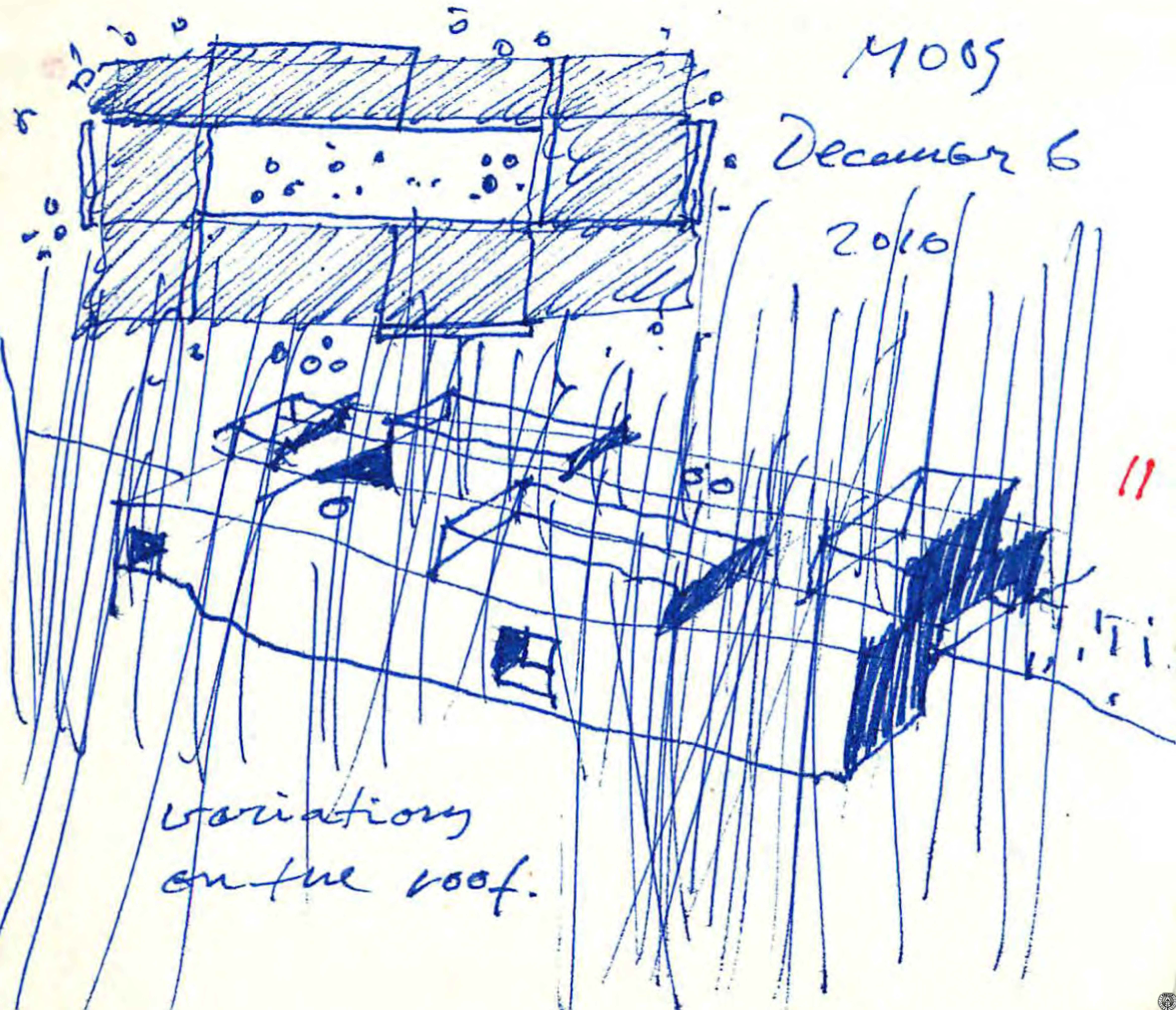

variations  
on the roof.

1400g

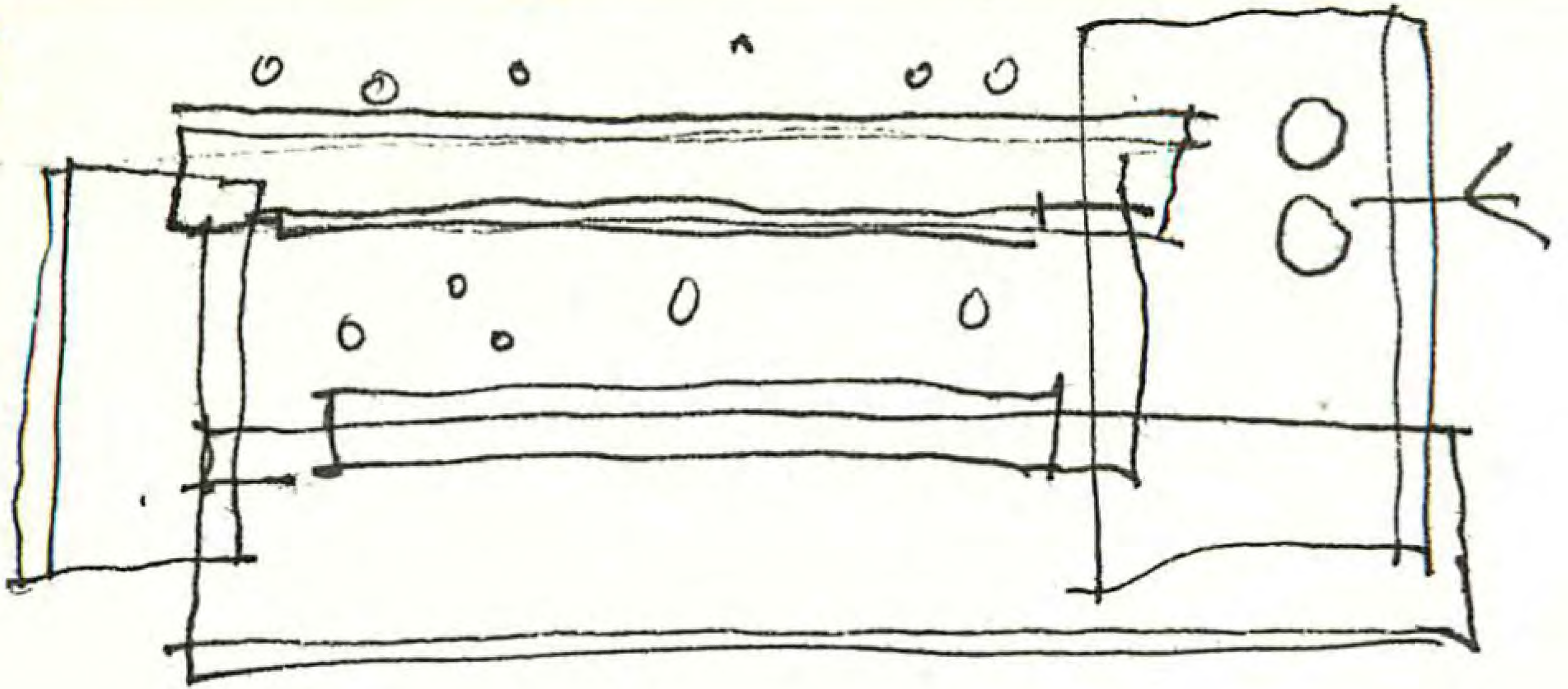

13

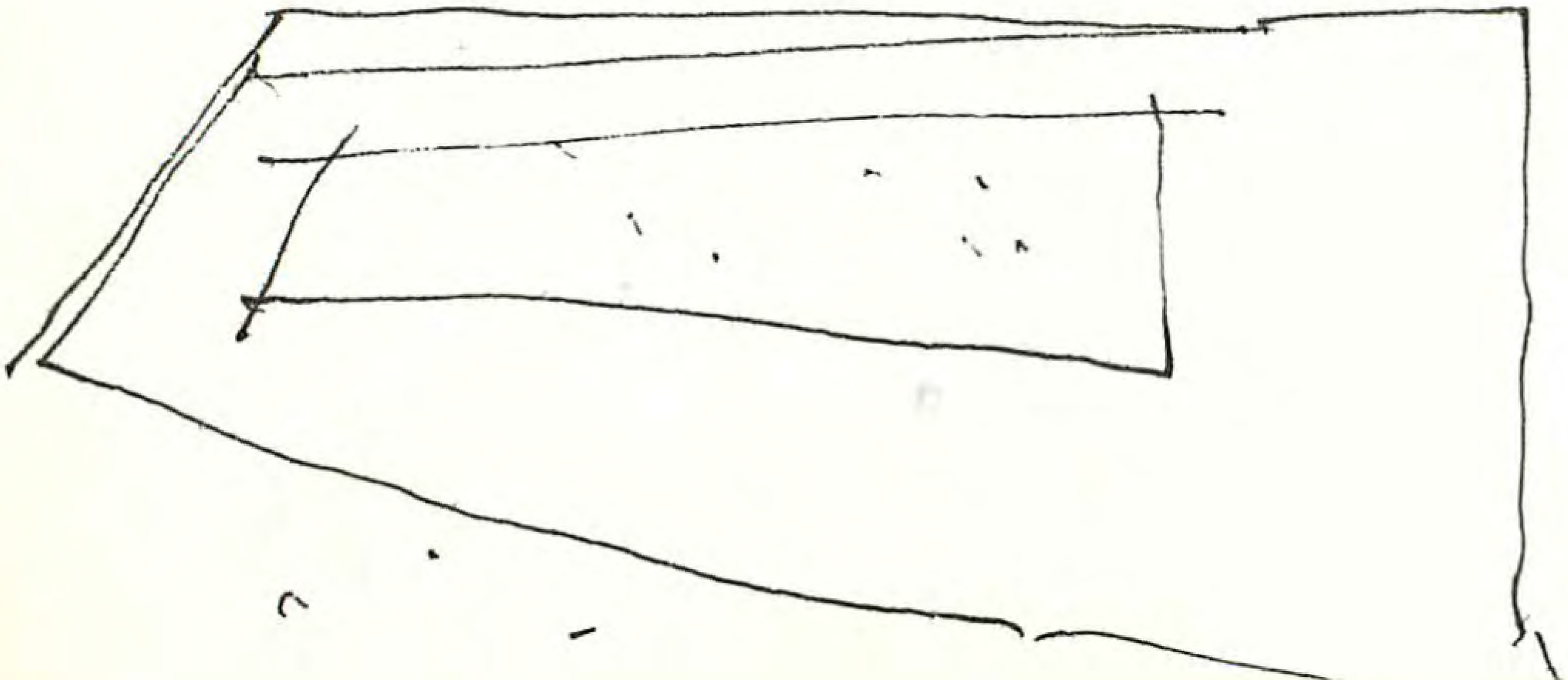

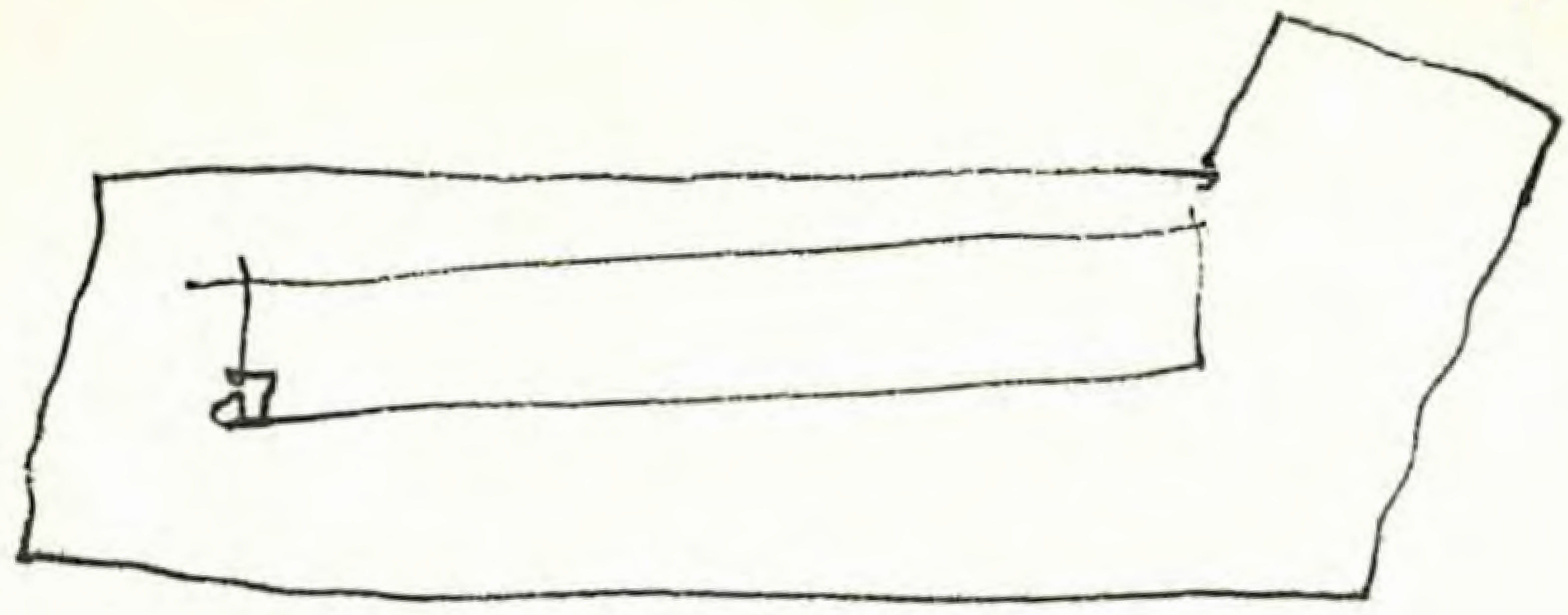

straus y yo  
 horadamos

nuestro tiulele desde  
 lados diferentes de la misma  
 montaña.

ya no encontraremos

Dec.

17

MOOS

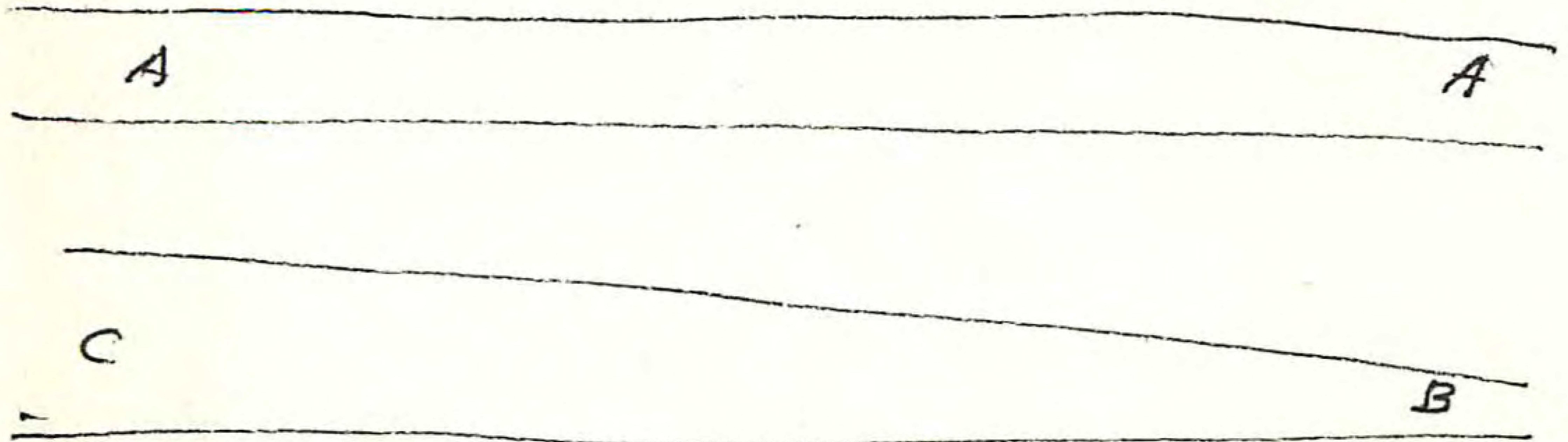

18

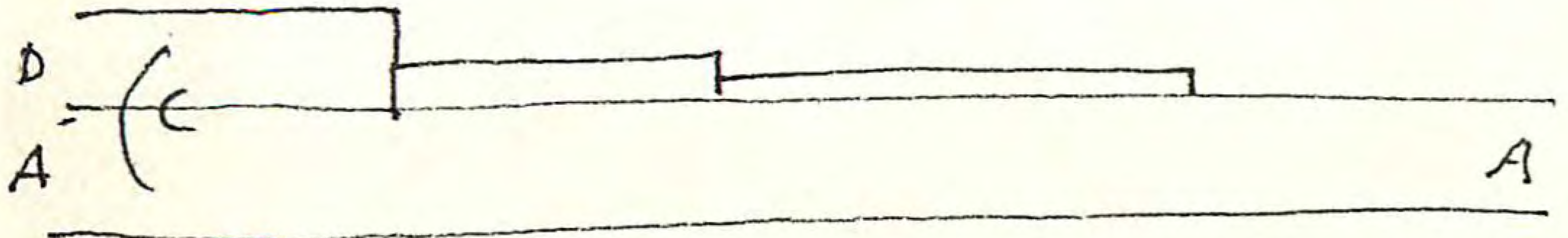
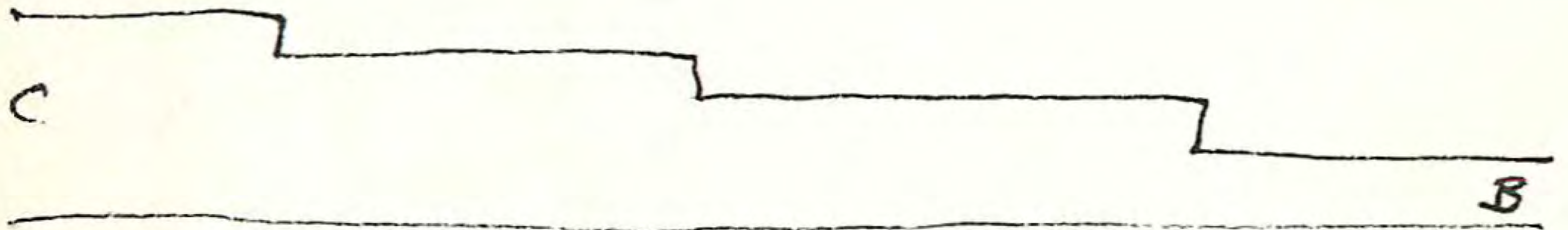

MOOS

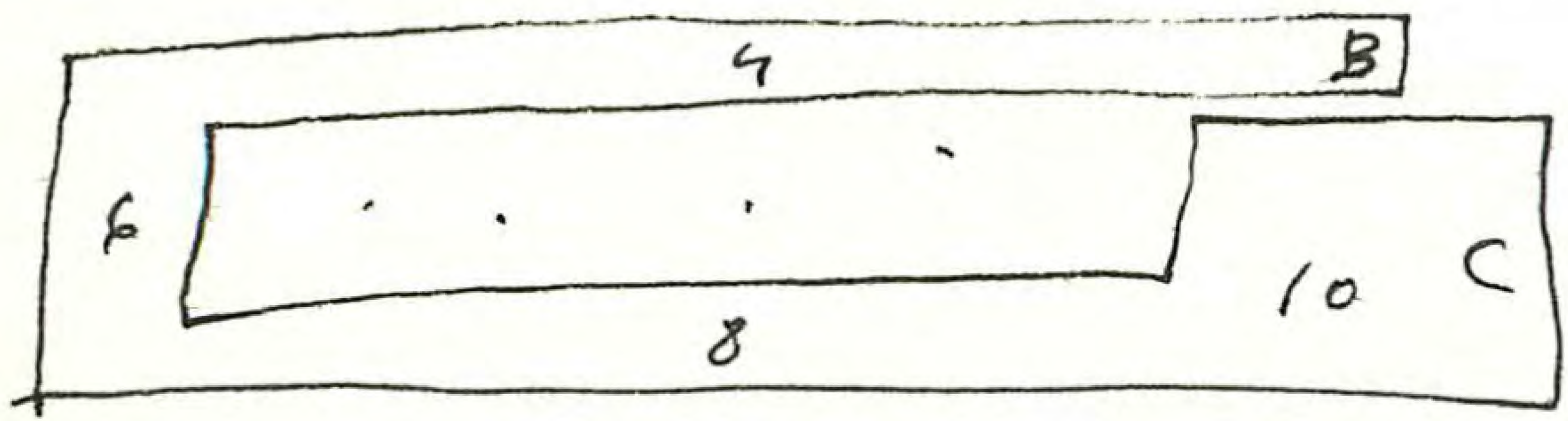
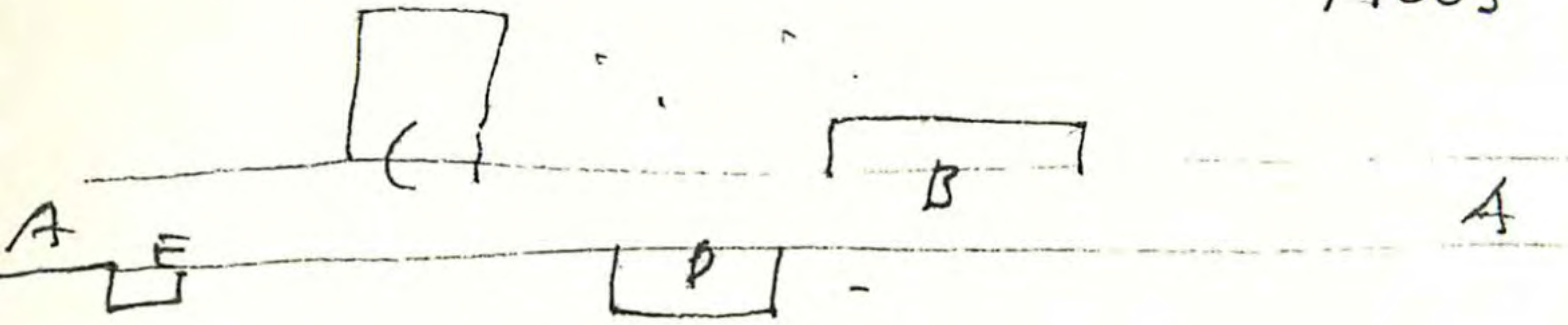

19

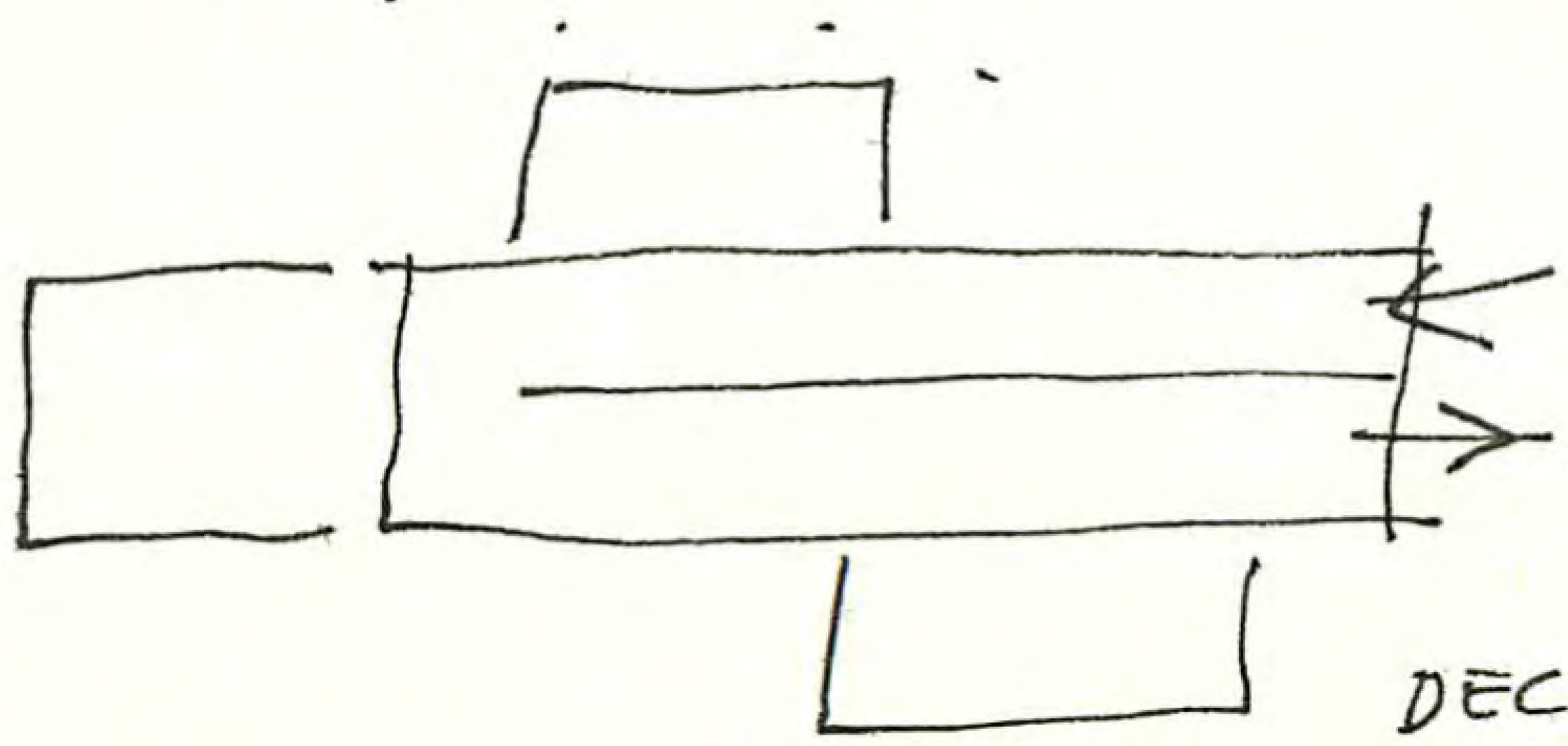

DEC 13, 2010

14005

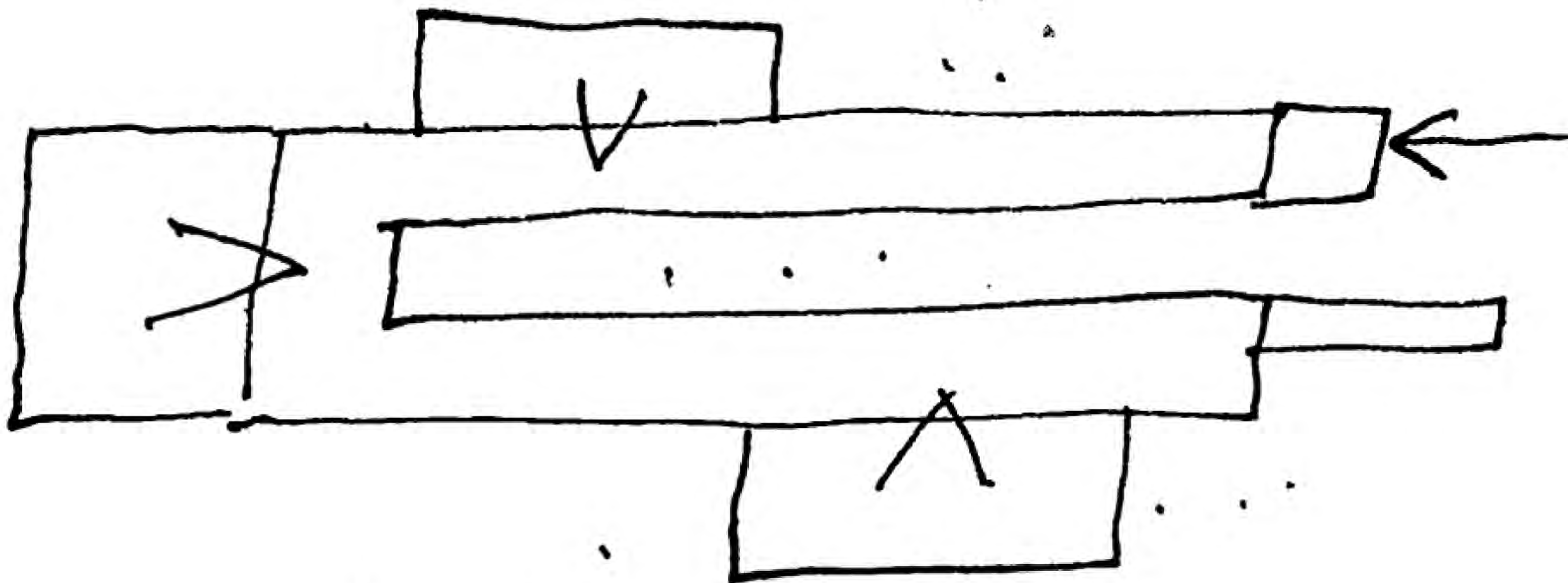

20

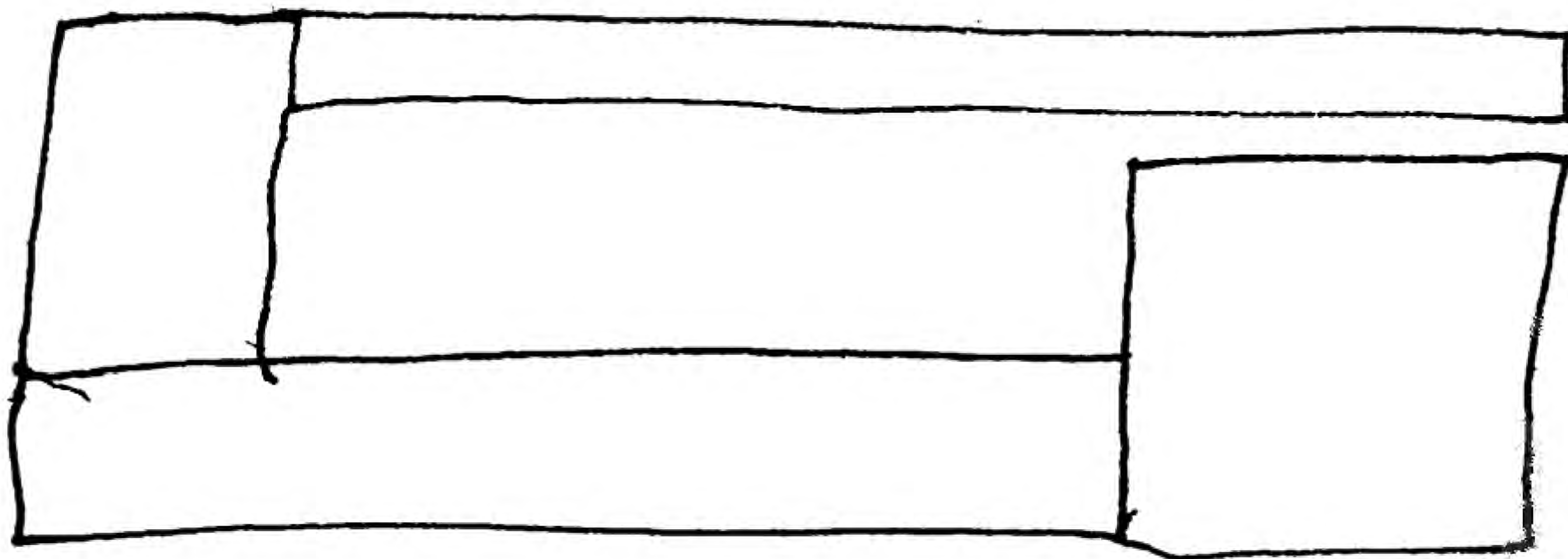

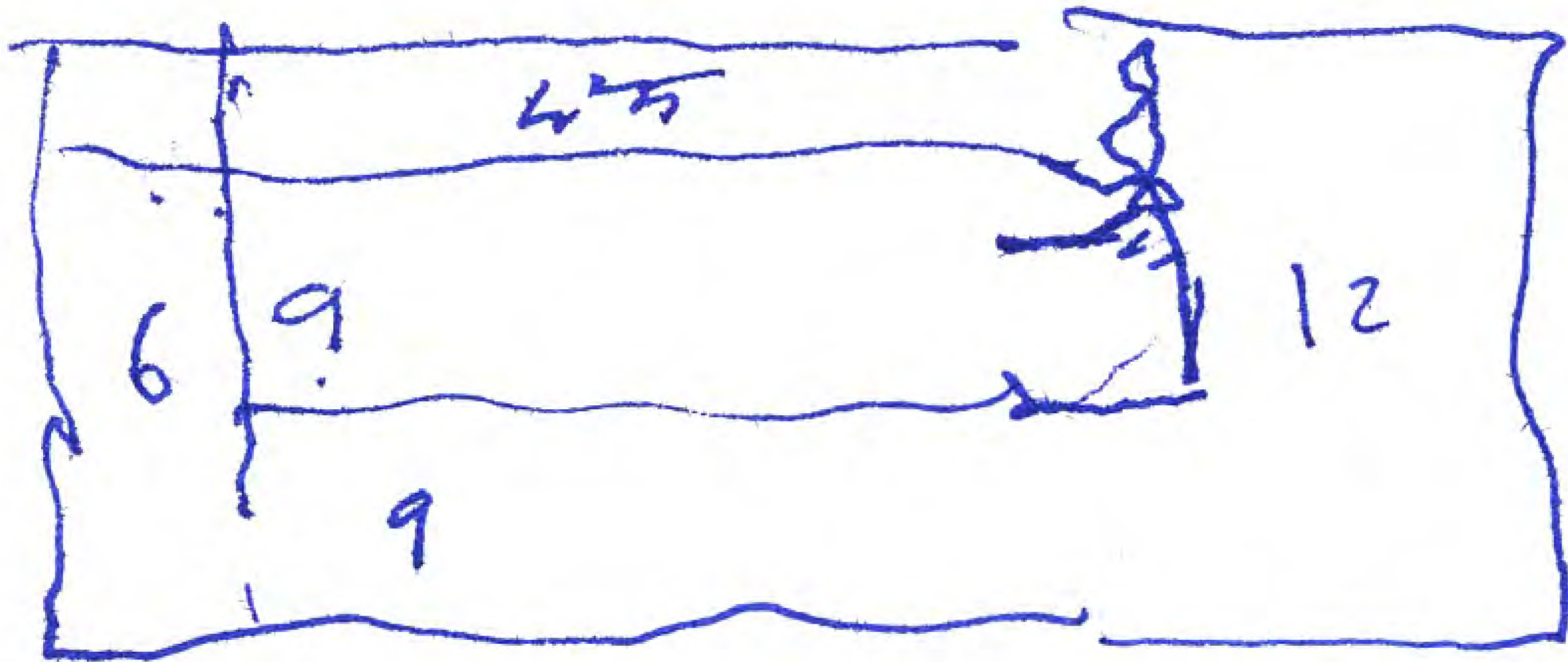

Room

24

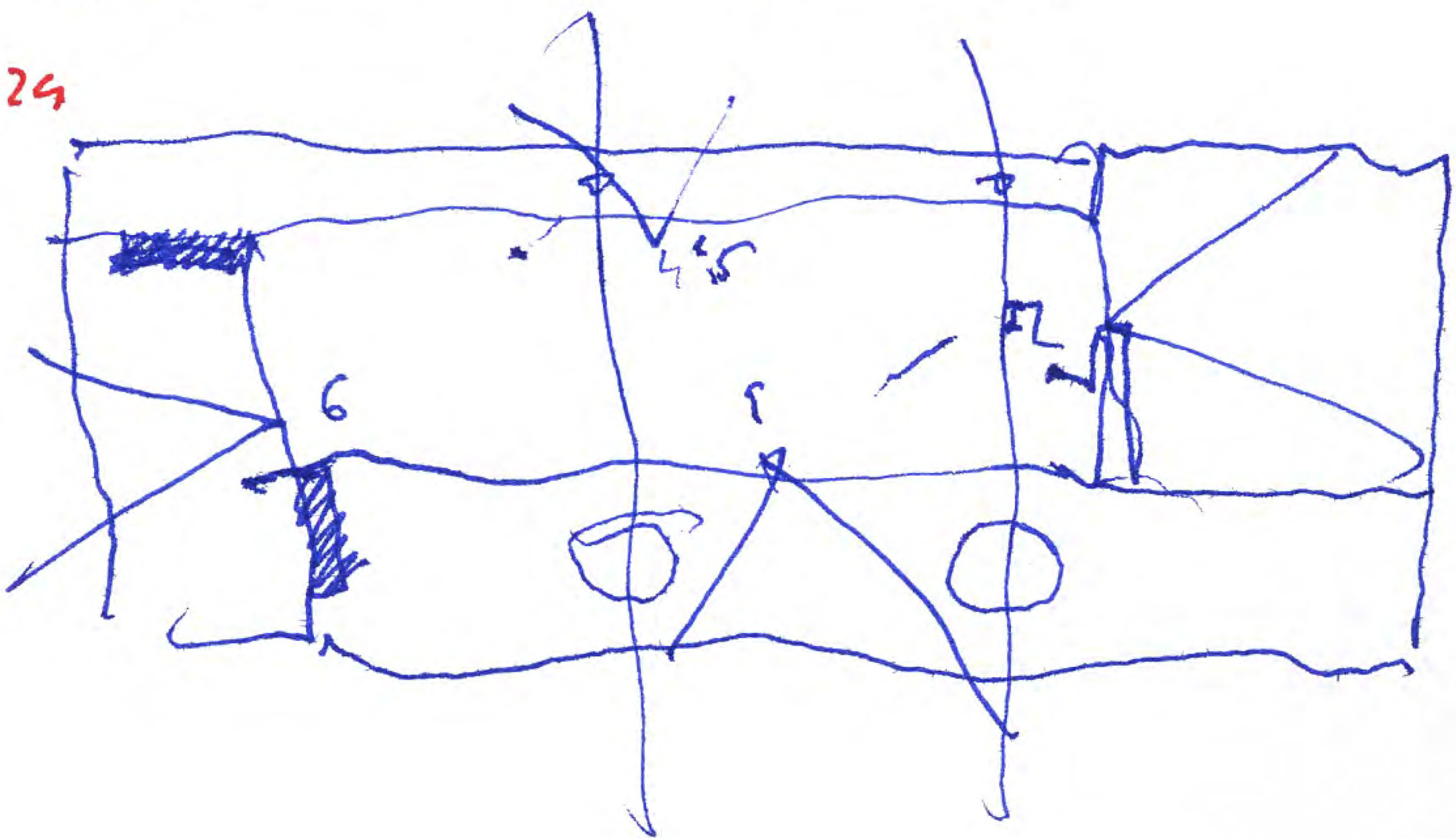



Moos

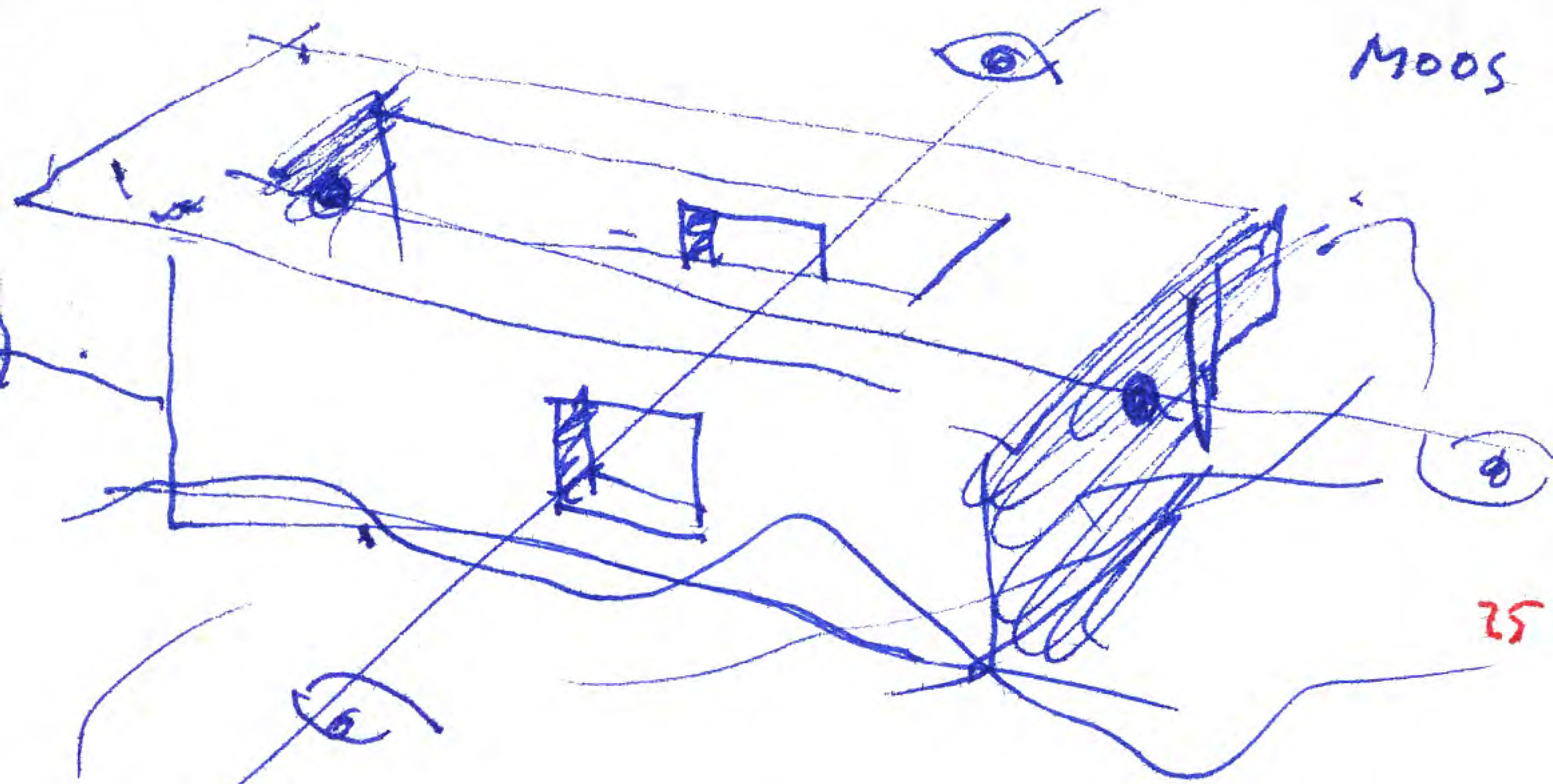

52

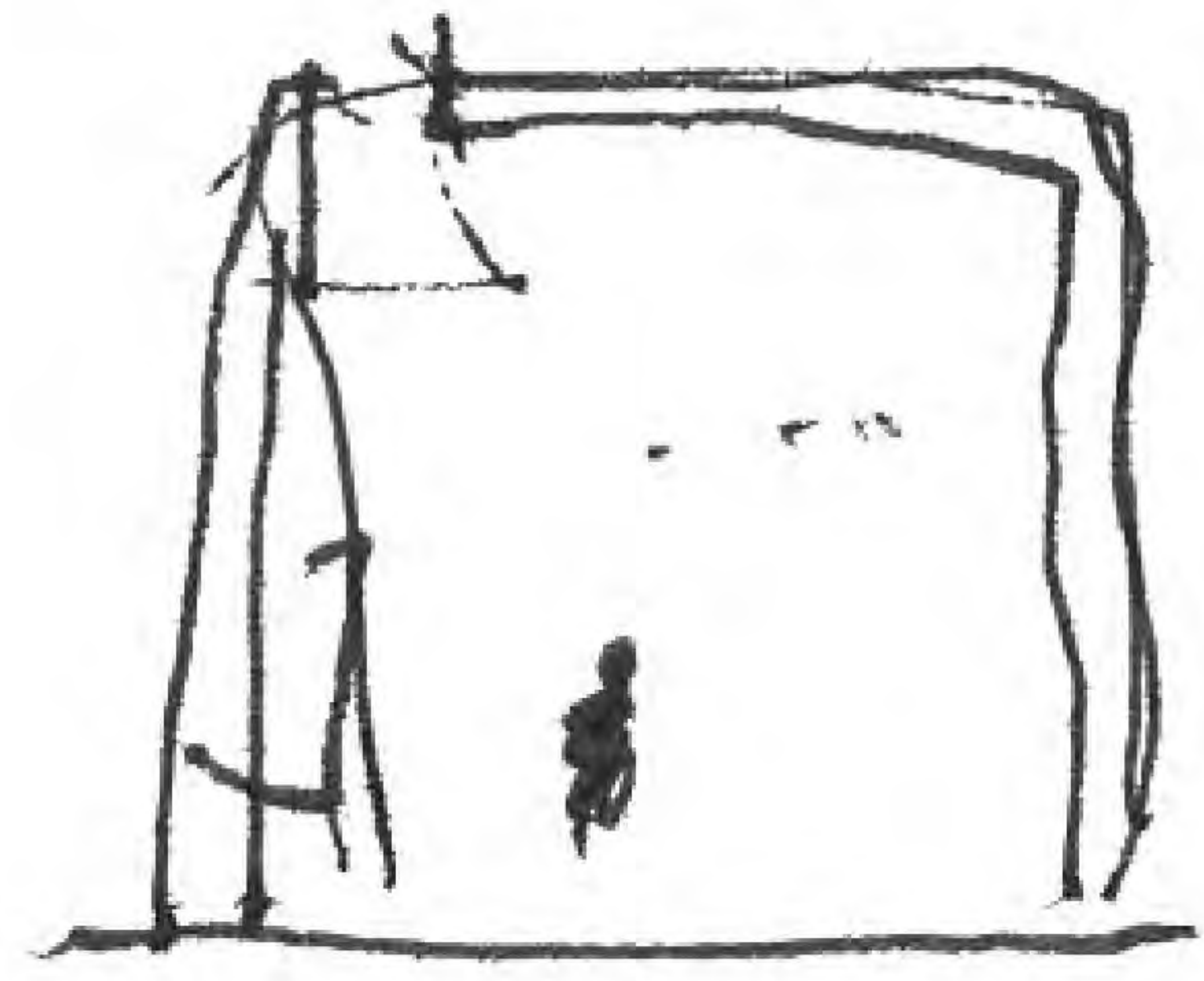

10  
11

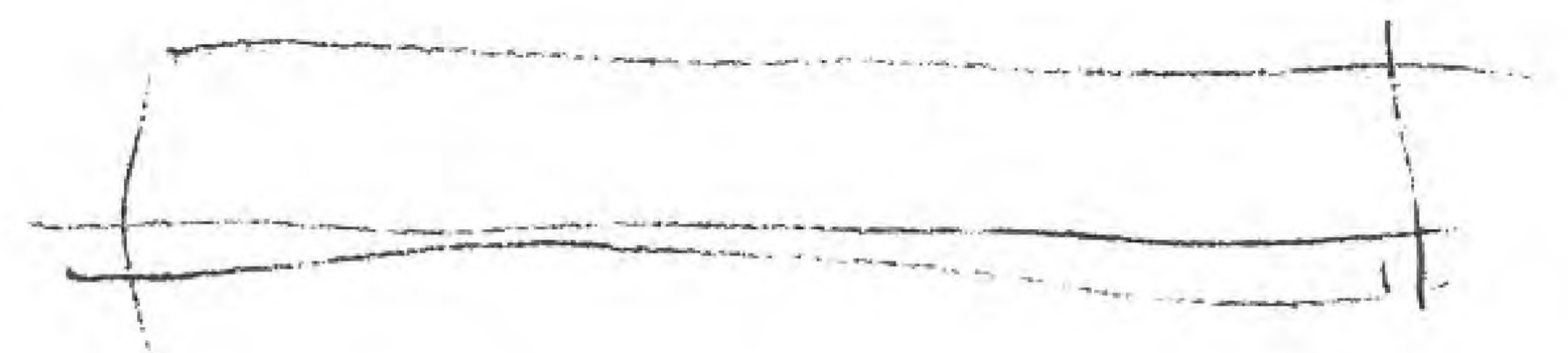

like likelihood probabilities  
to turn down.

MOAS

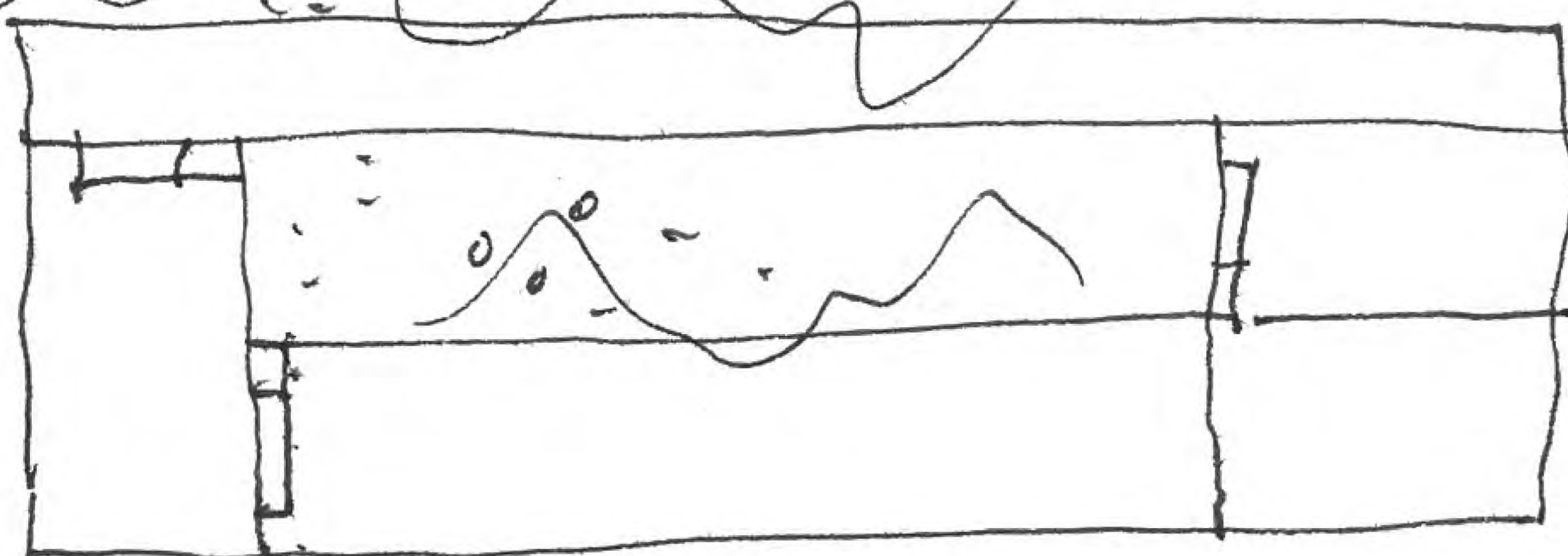
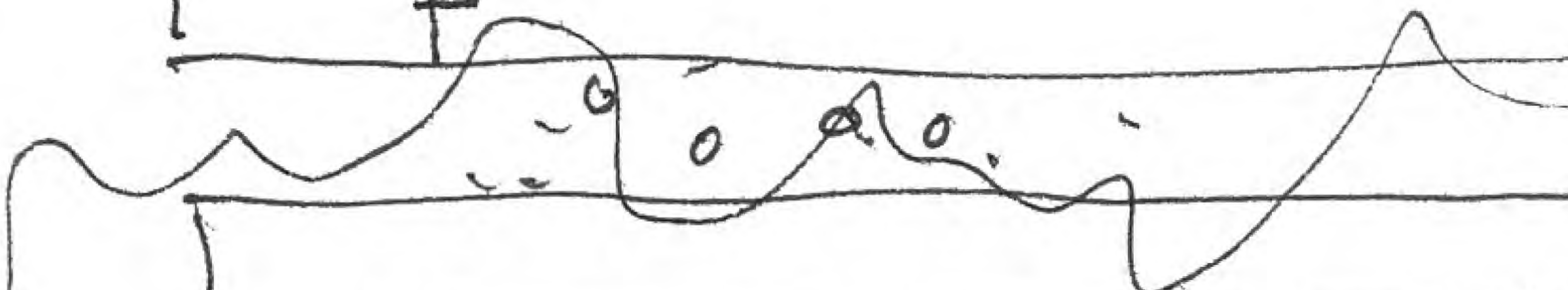
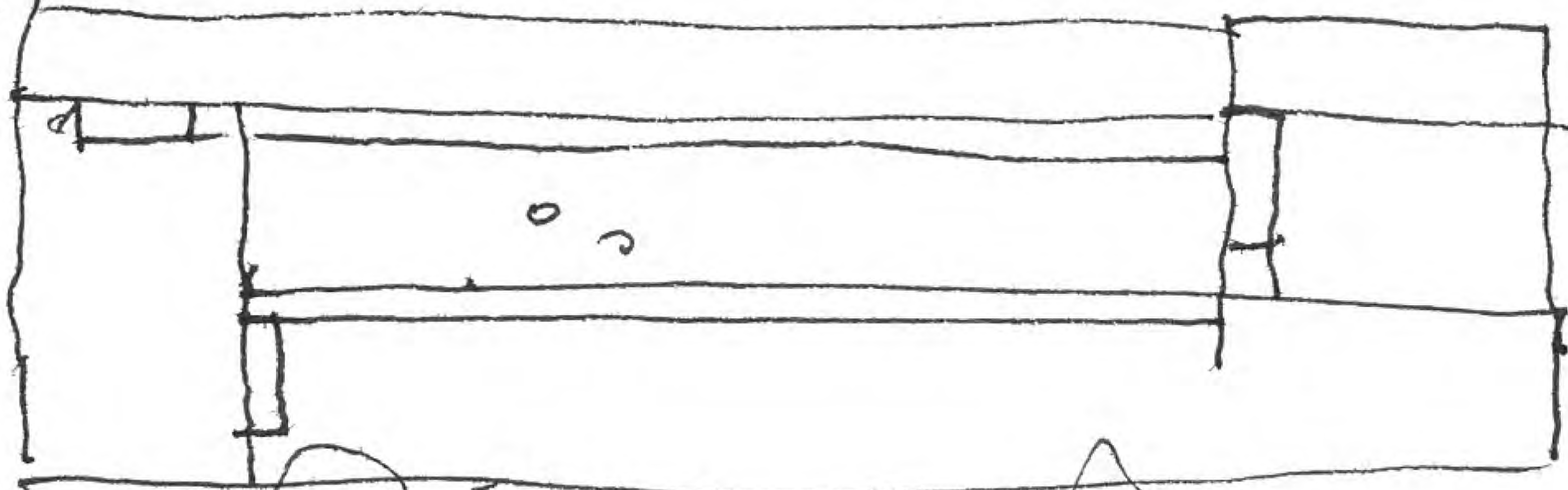

27

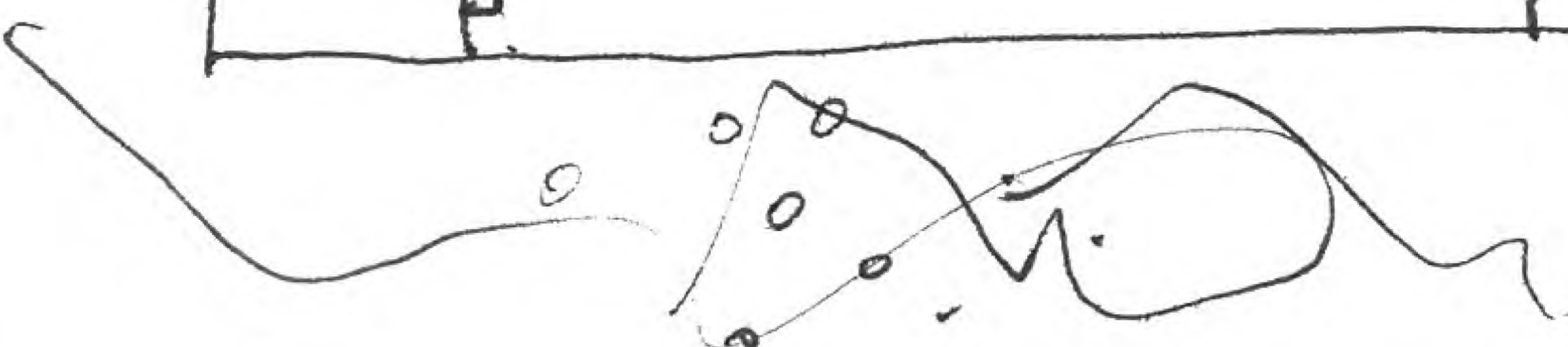

Dec 17 2010

M2003

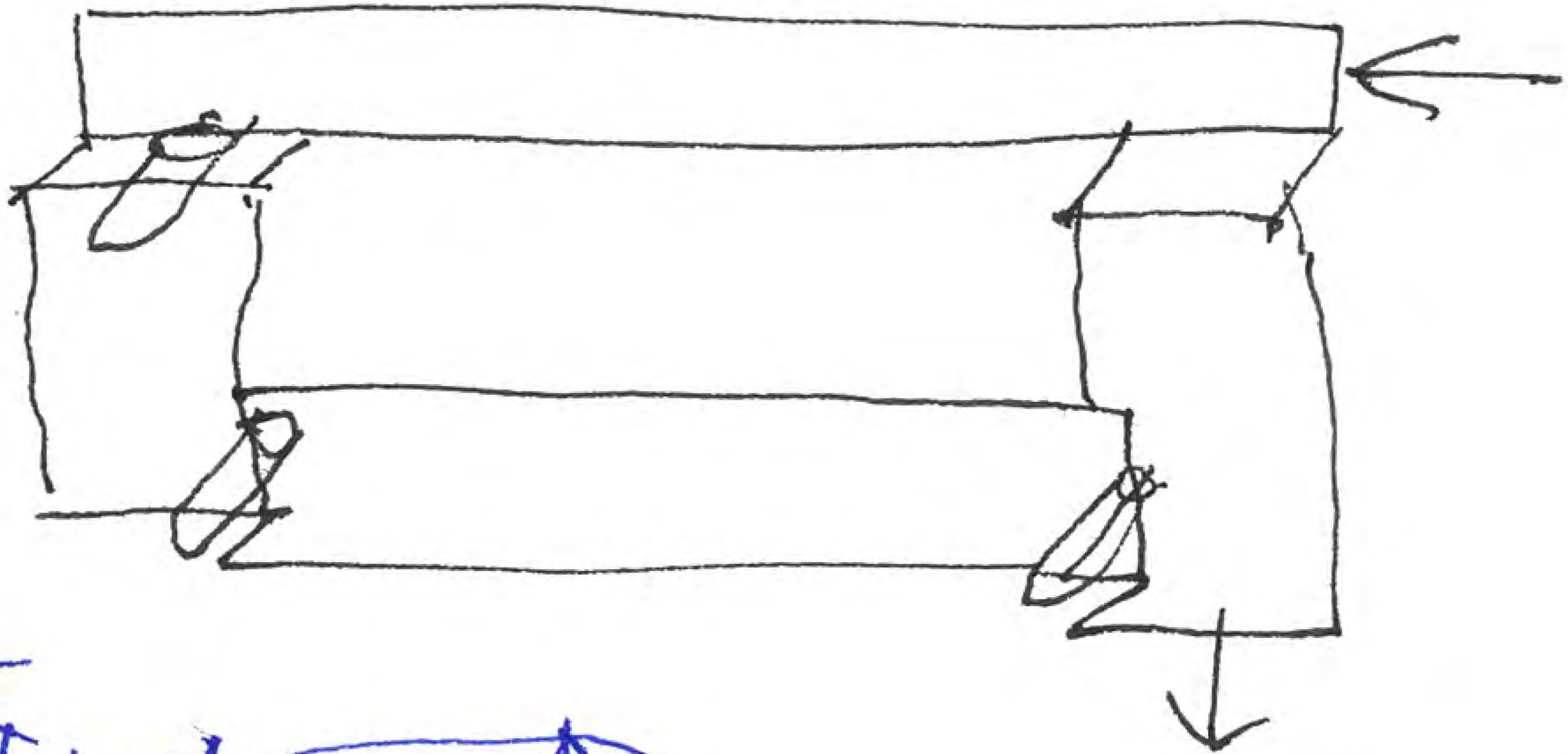

28

VT.

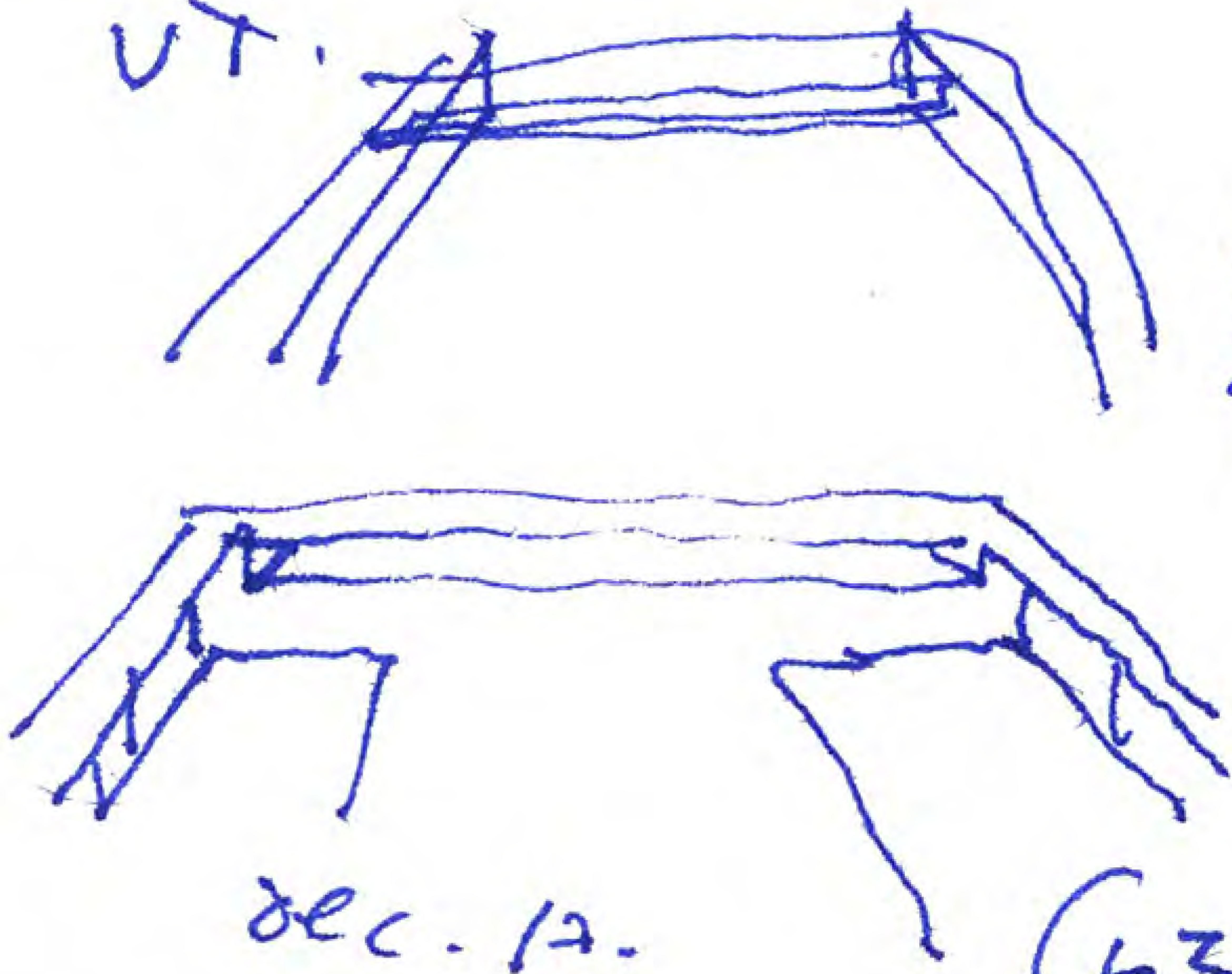

dec. 12.



como en EC

6 8 8

22



(LZ 1500) (VT. 500)

M005

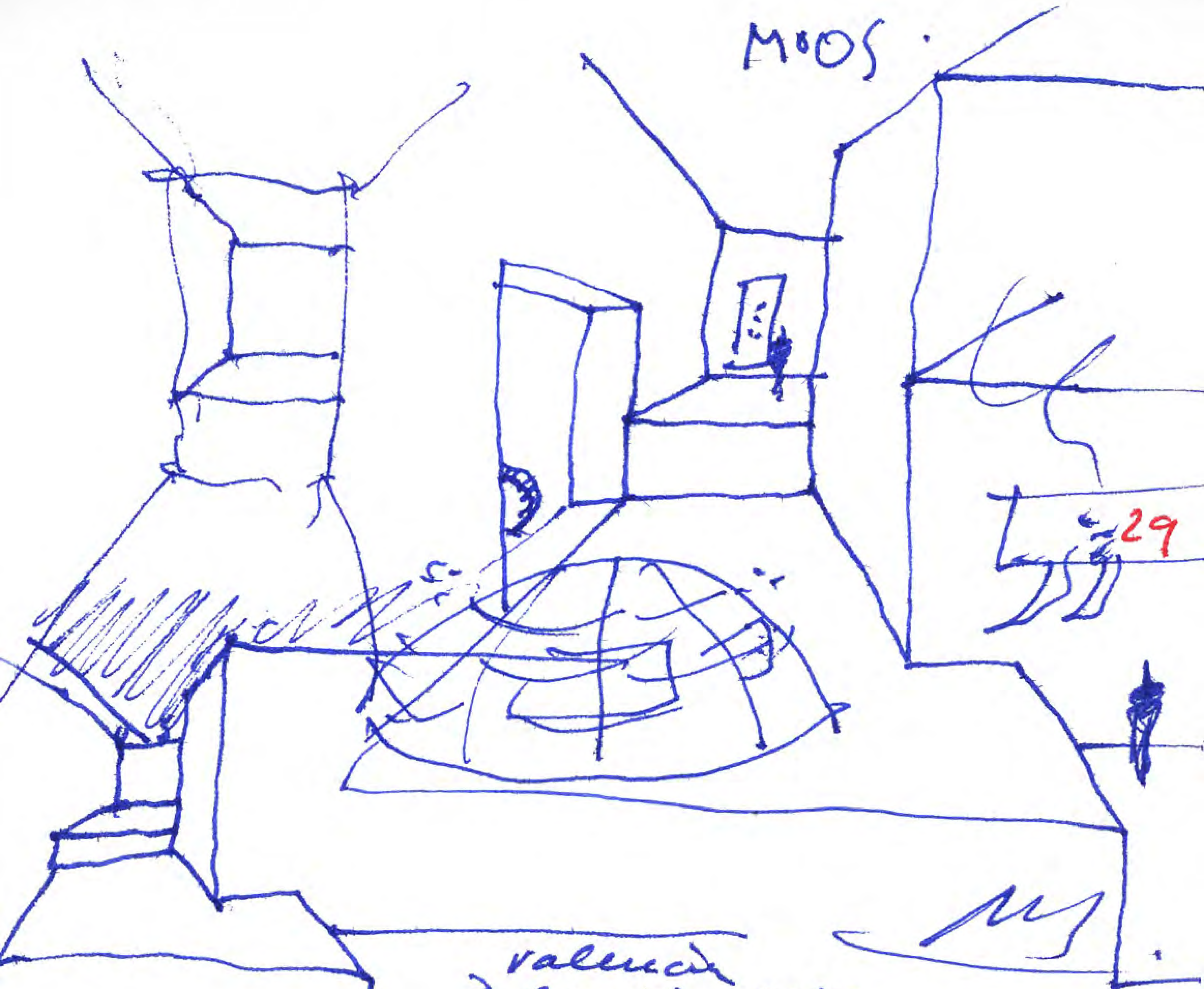

29

valencia  
2018.18.2010

MS

MOOS

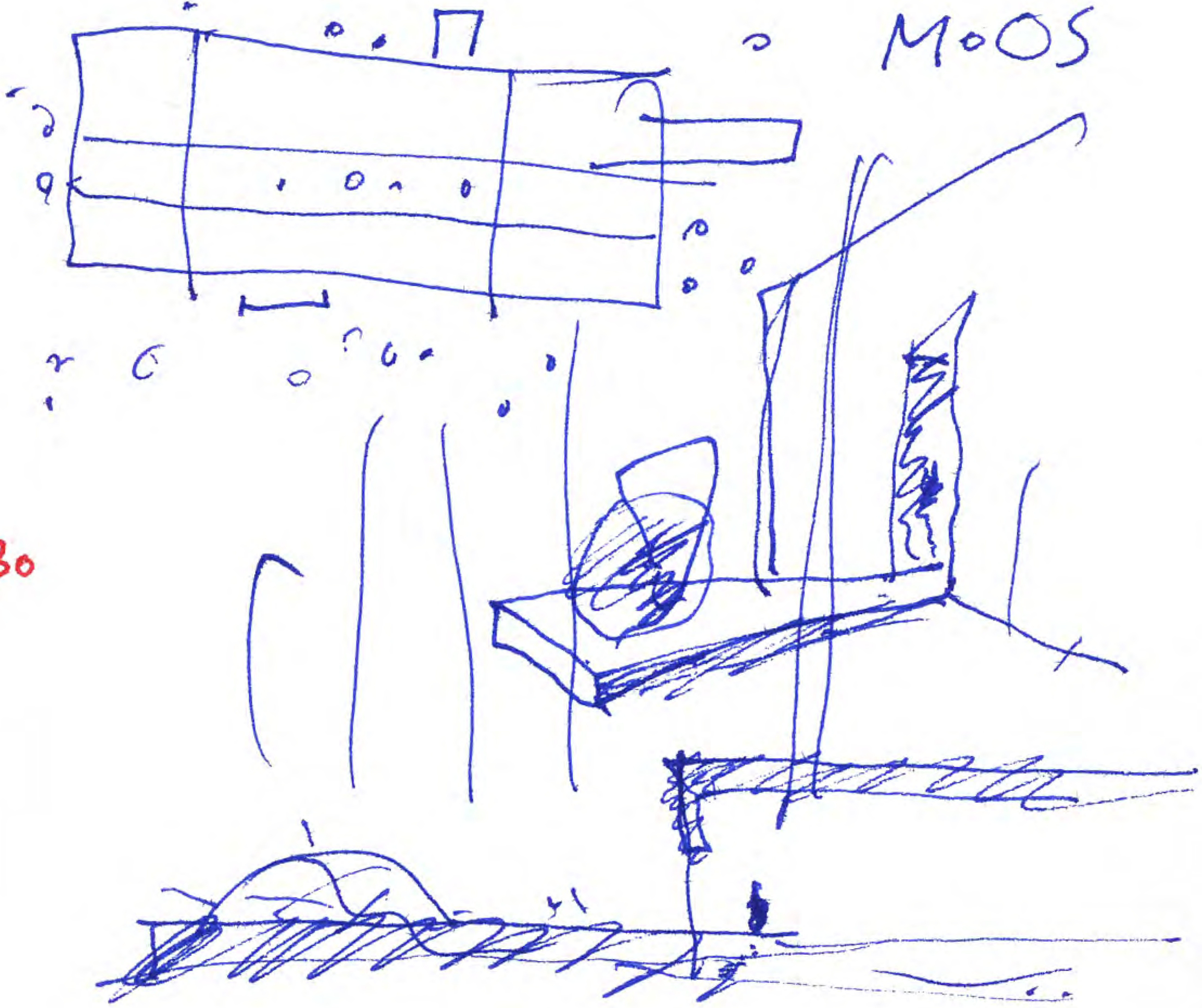

30

LZ



31

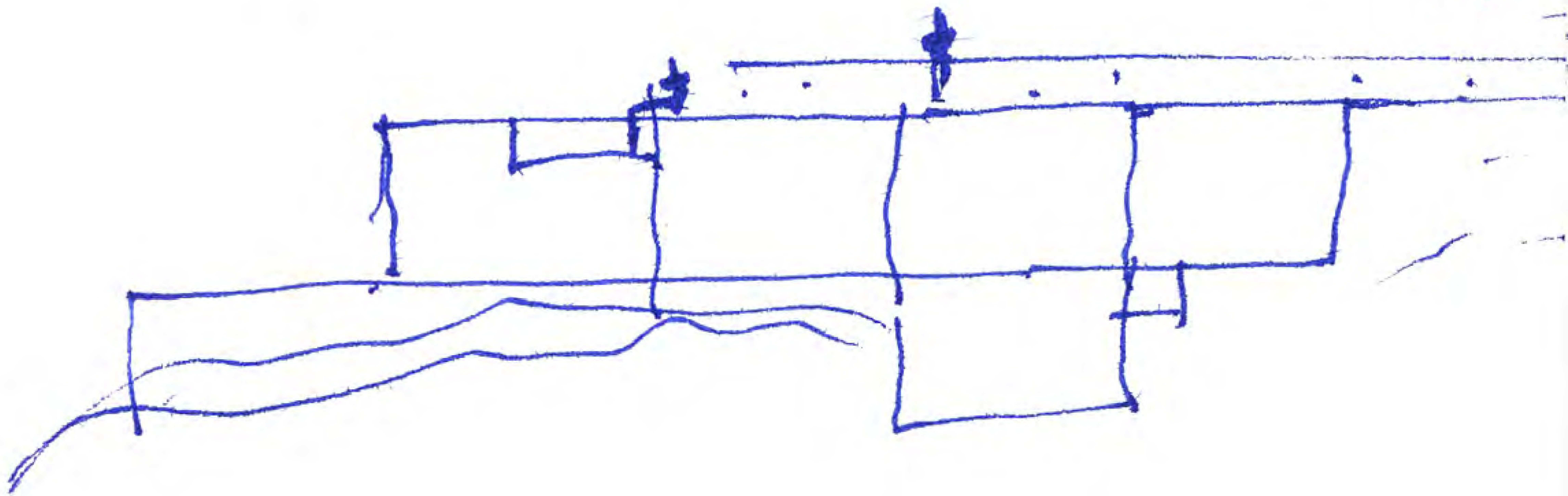

UT

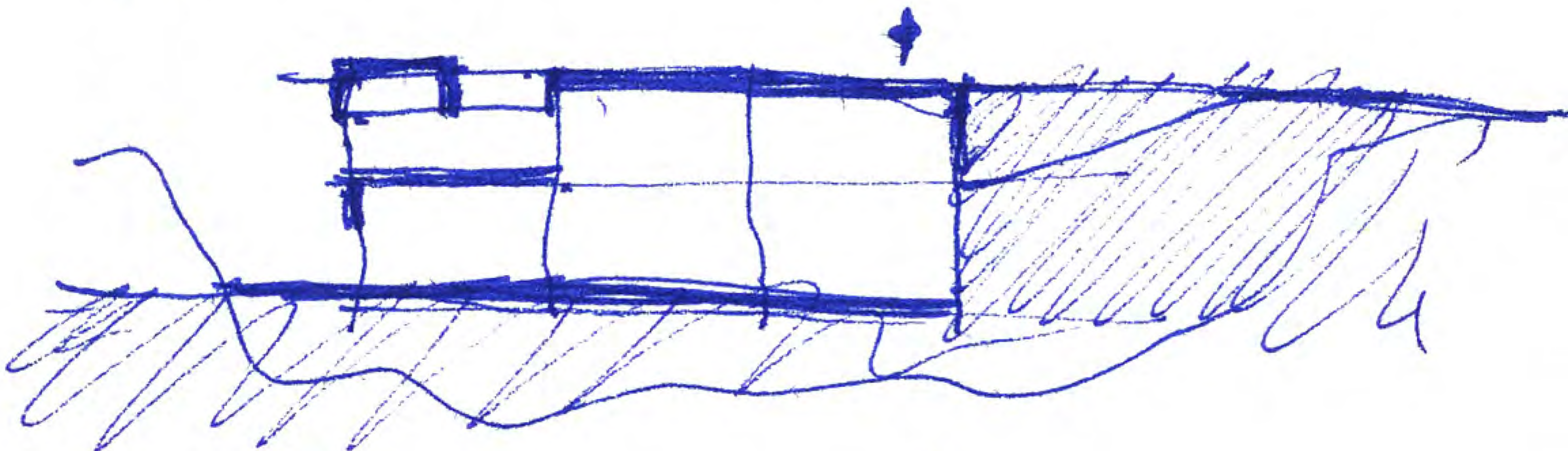

32

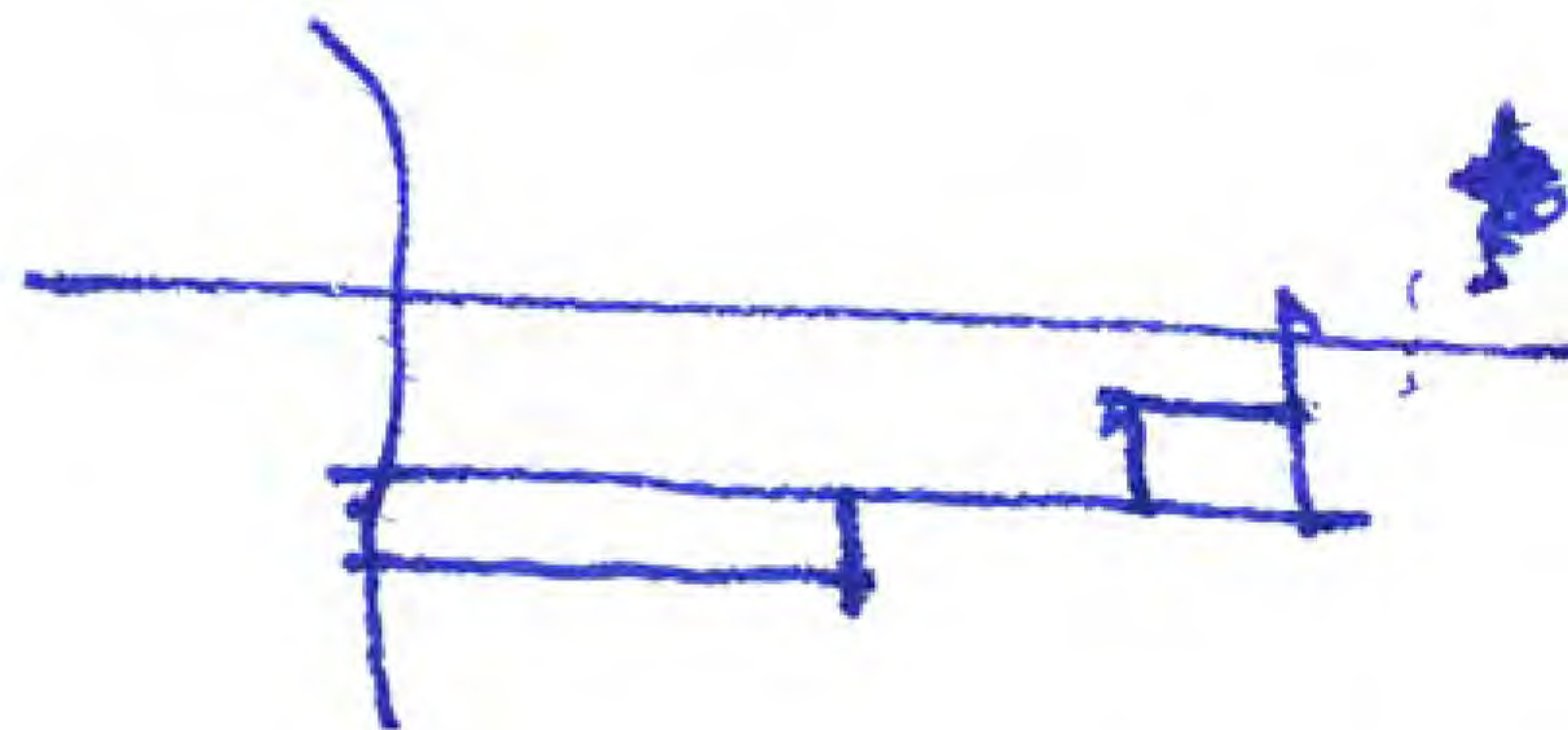

---

DEC 18 2010

M00J

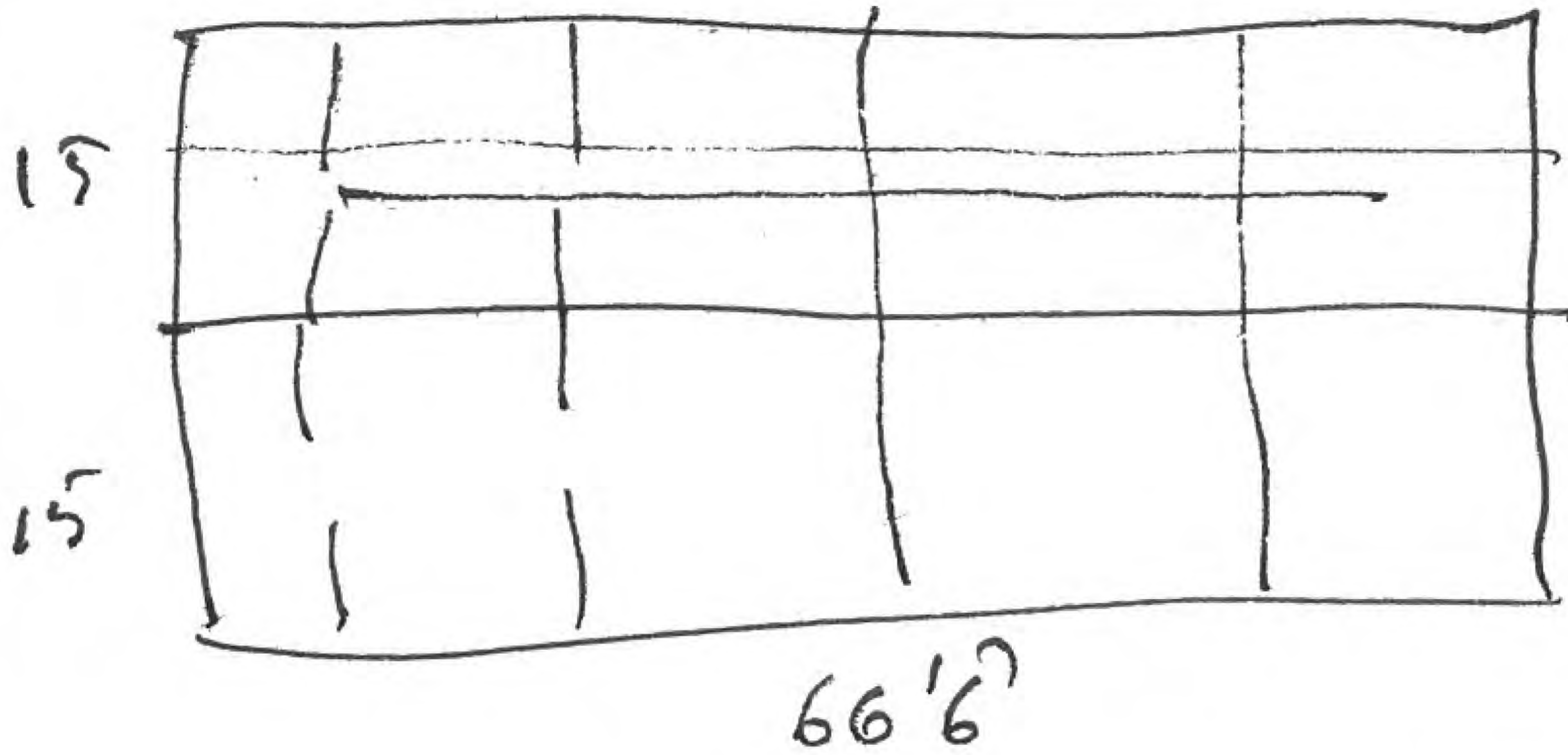

36

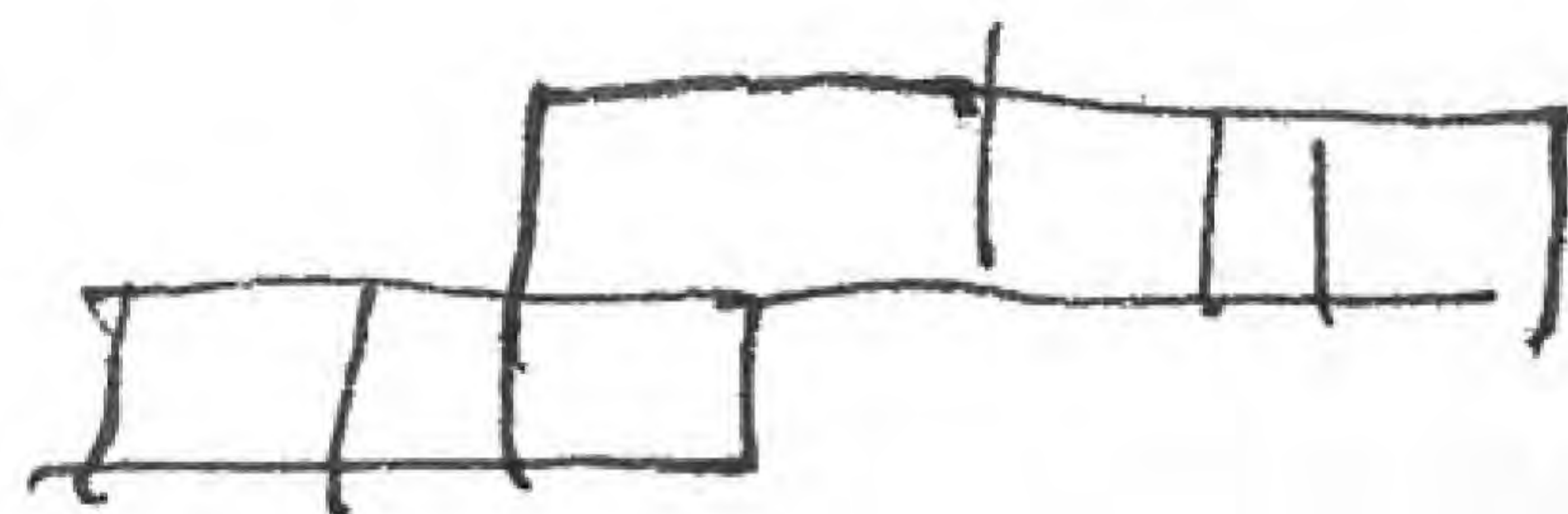
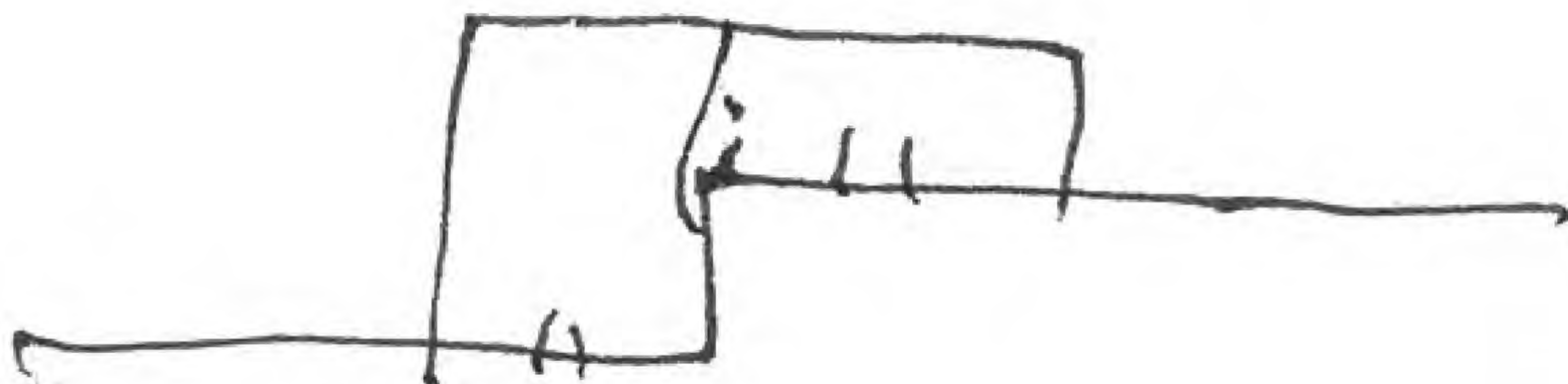
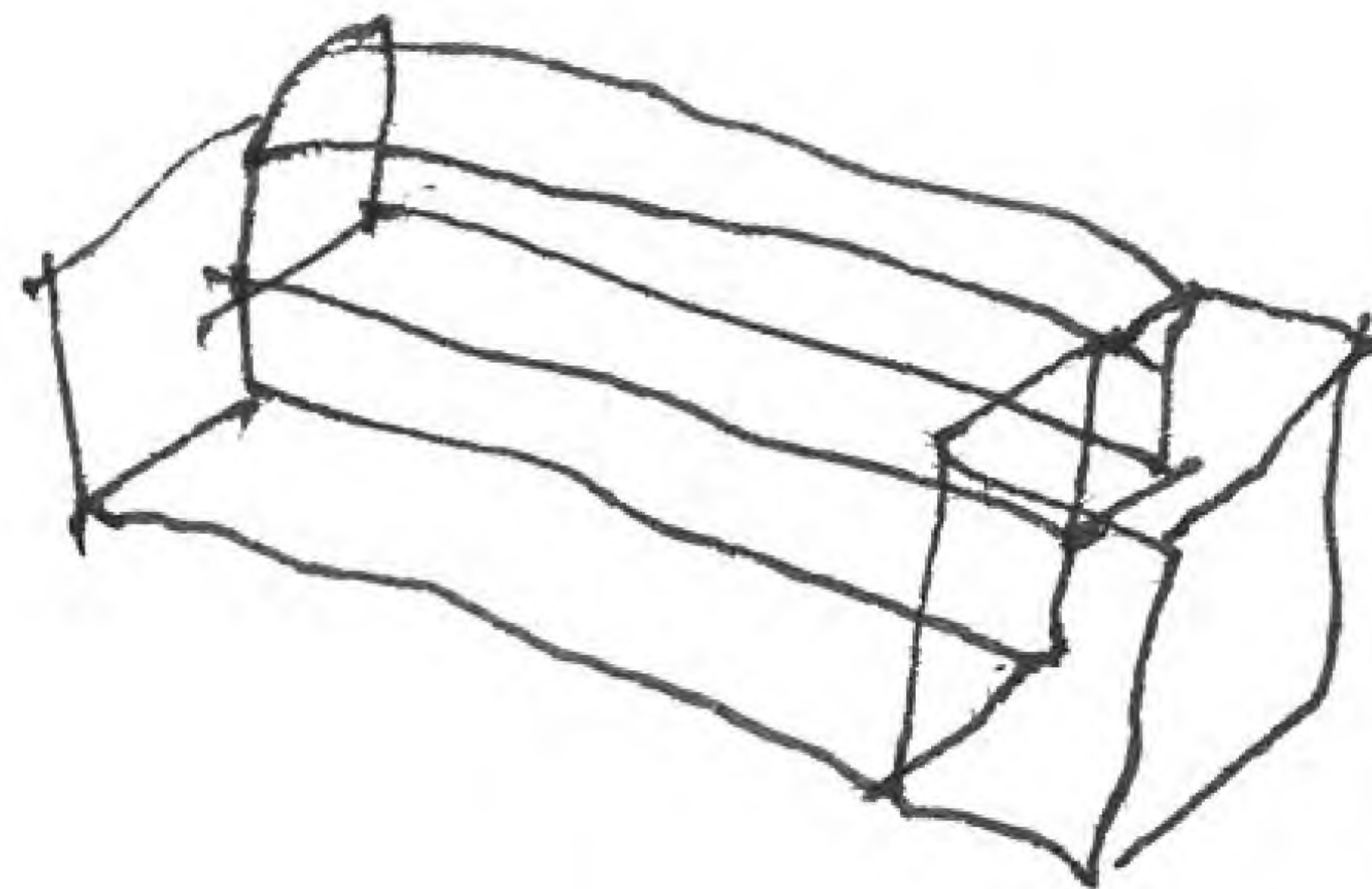
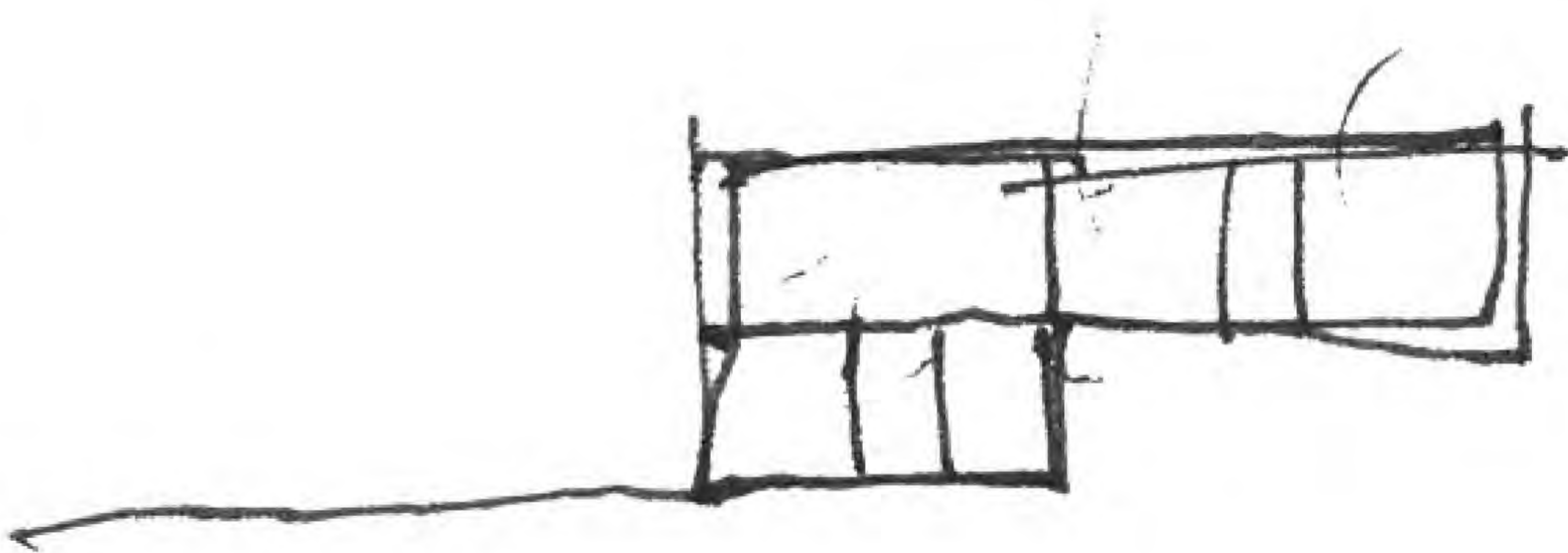



1000

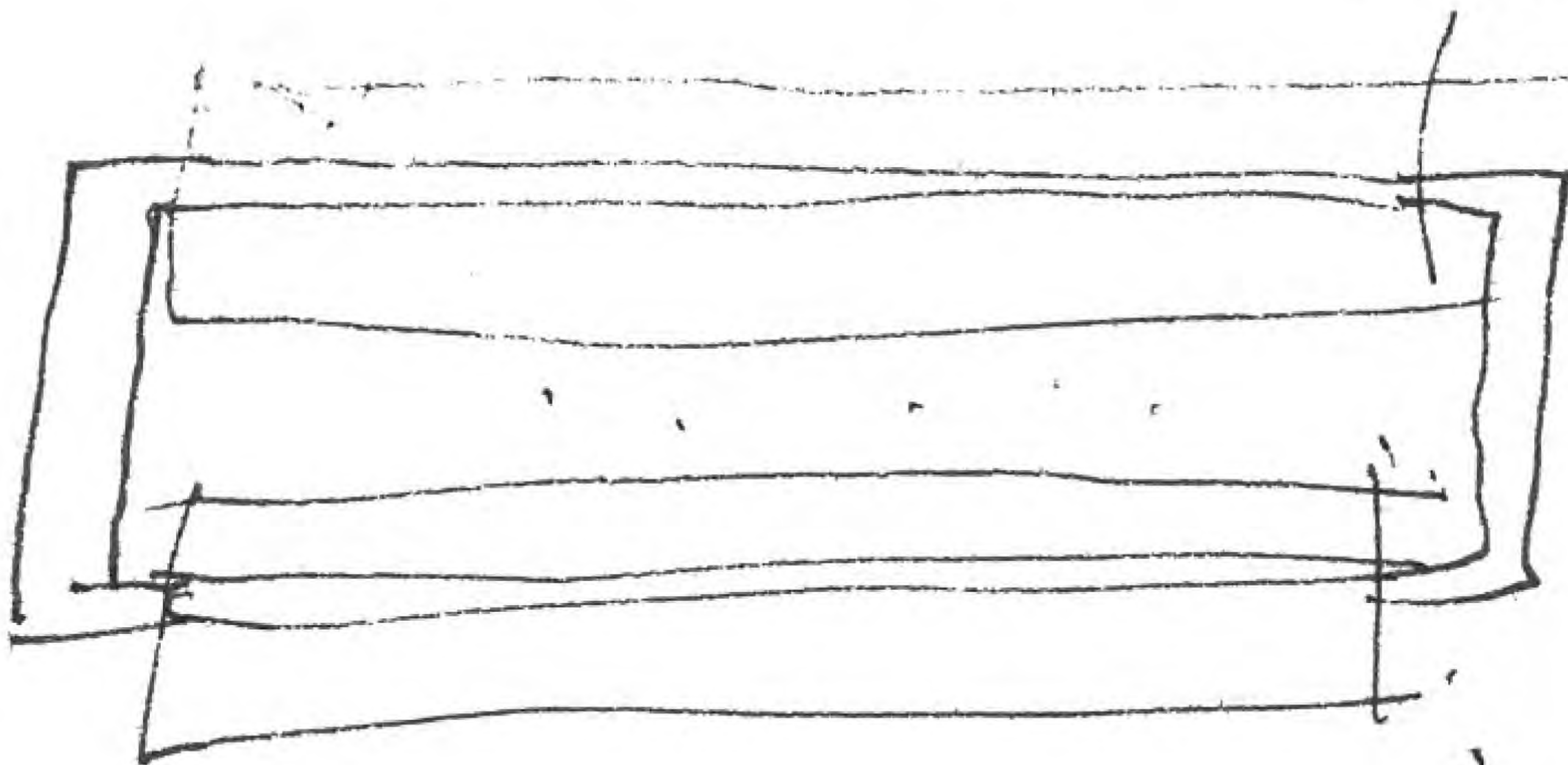
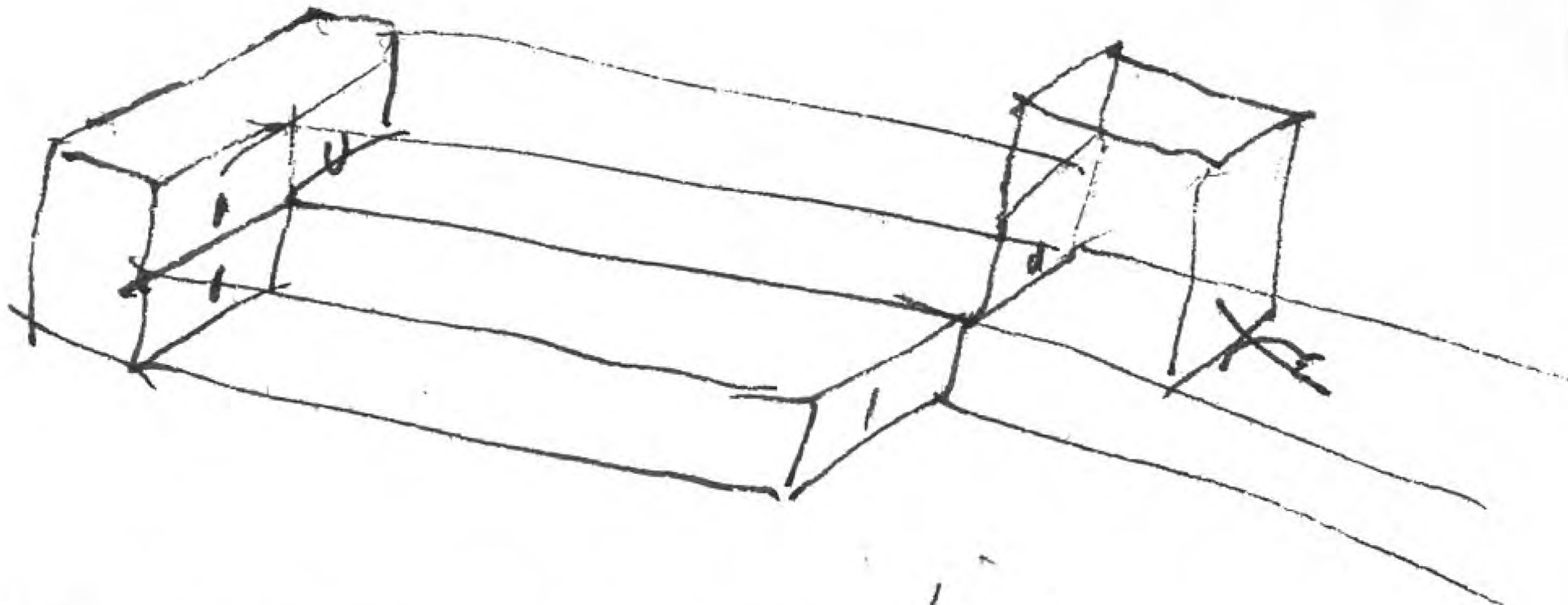

37

MOOS

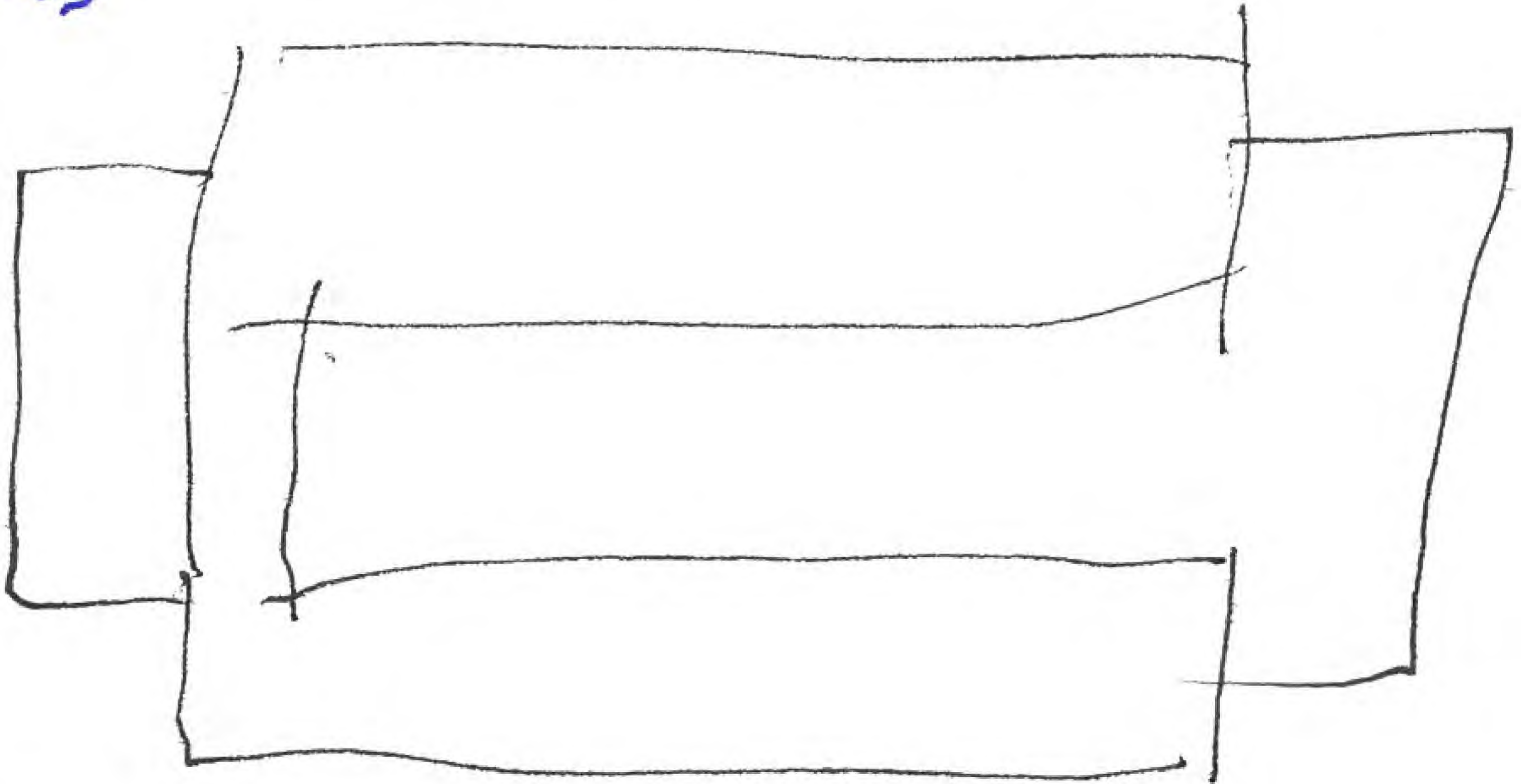

38

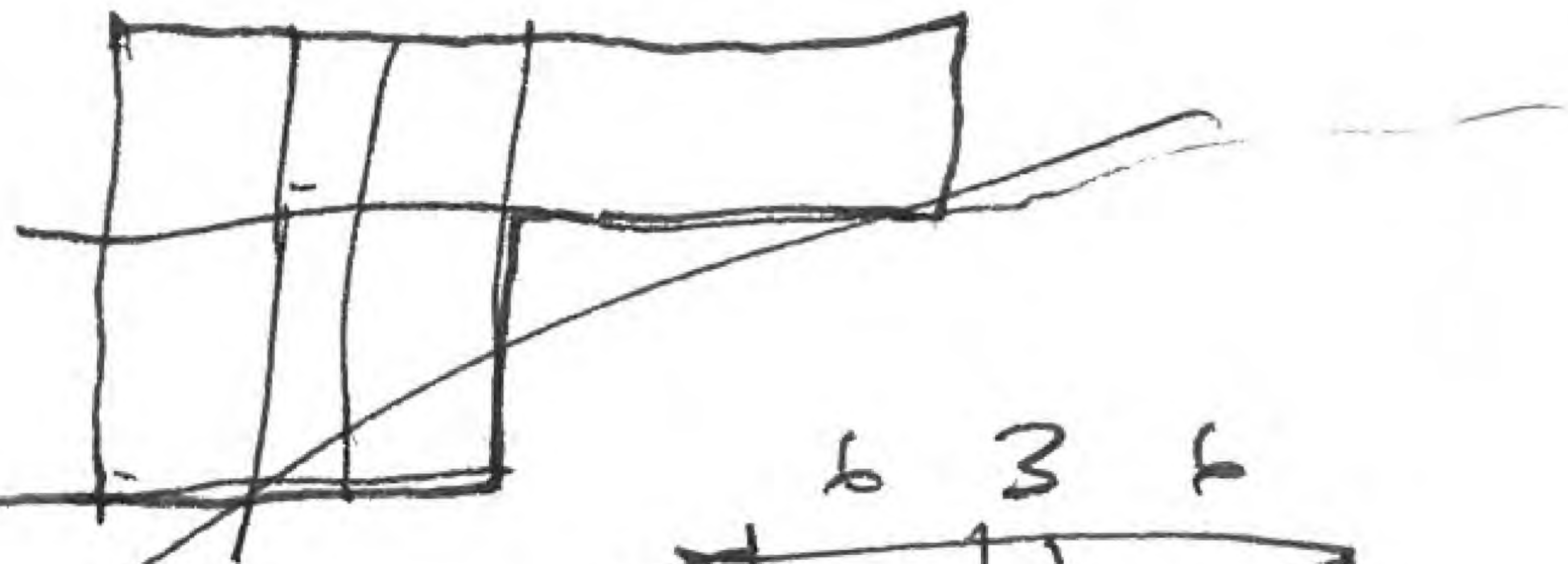

6 3 6

12 x 60

9 x 60

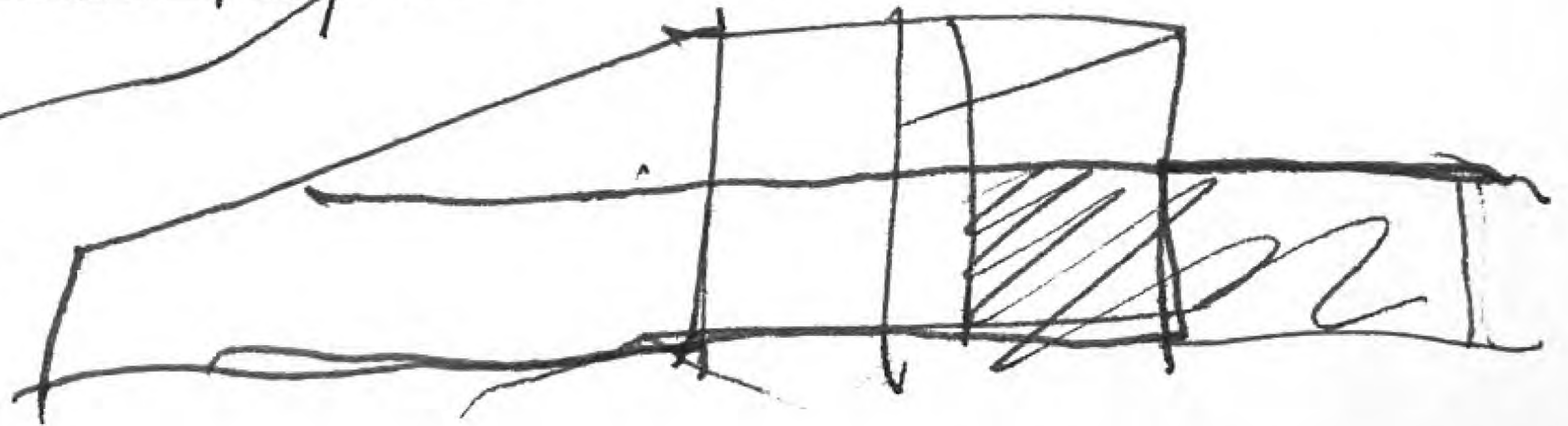

$$\begin{array}{r} 2500 \\ 50 \\ 50 \\ 50 \end{array} \quad \begin{array}{r} 15 \\ \hline 133\frac{1}{3} \end{array}$$

66'6"

Moop.

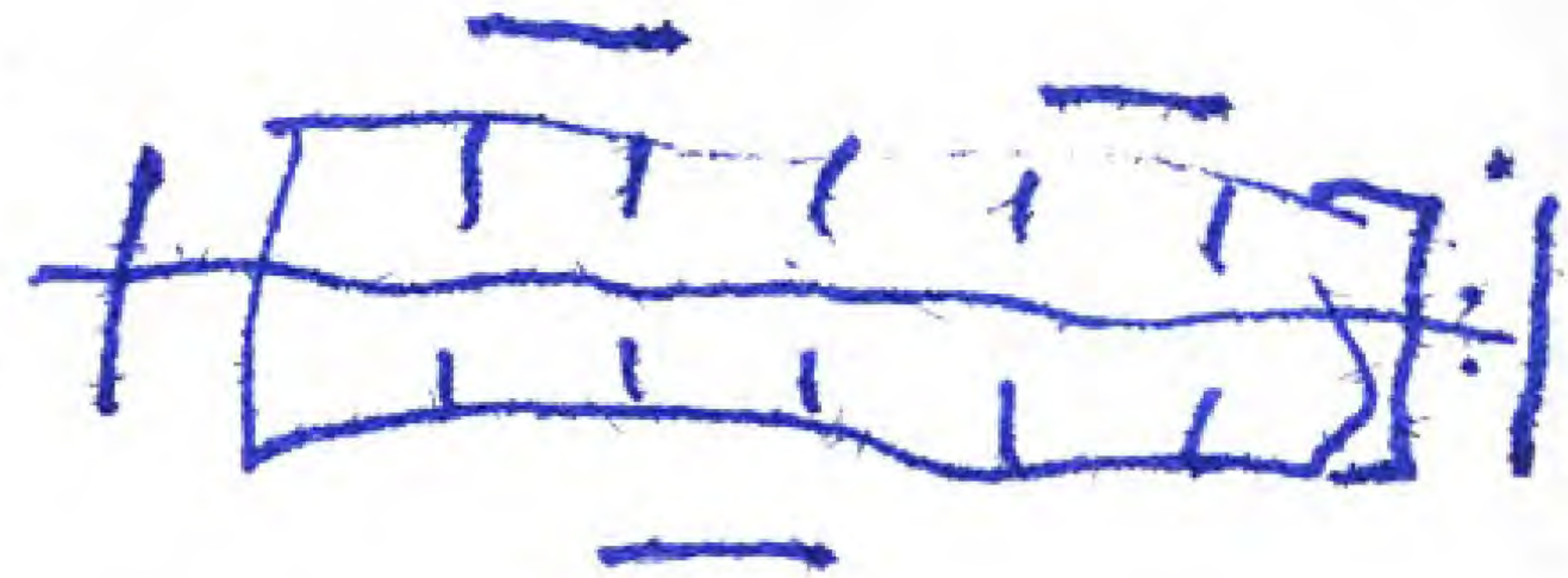

2000 m<sup>2</sup>

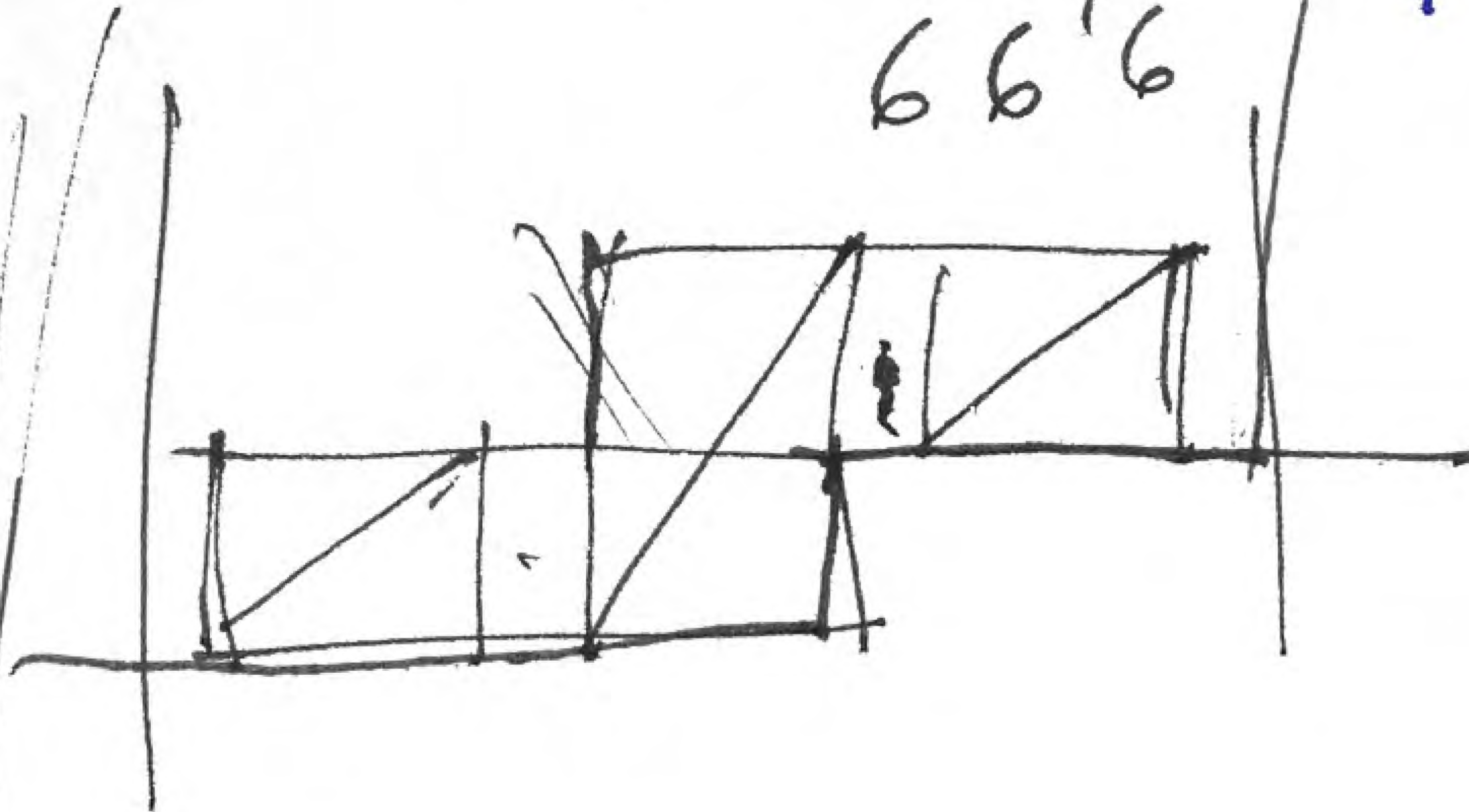

39

7 puntos en las banderillas  
de la rama /

Orquesta baranca - Venturico

OBS

36

MOOS

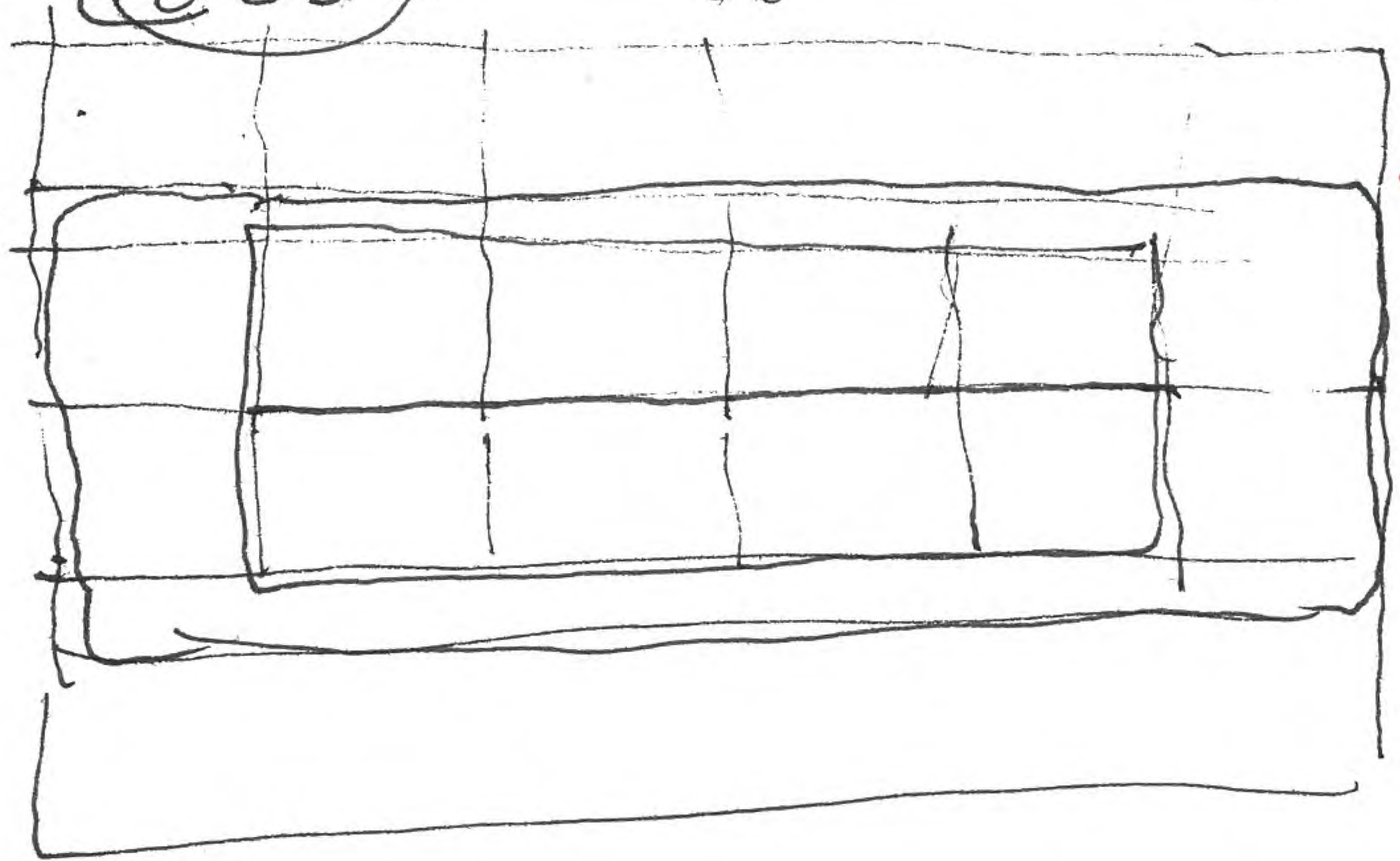

14005

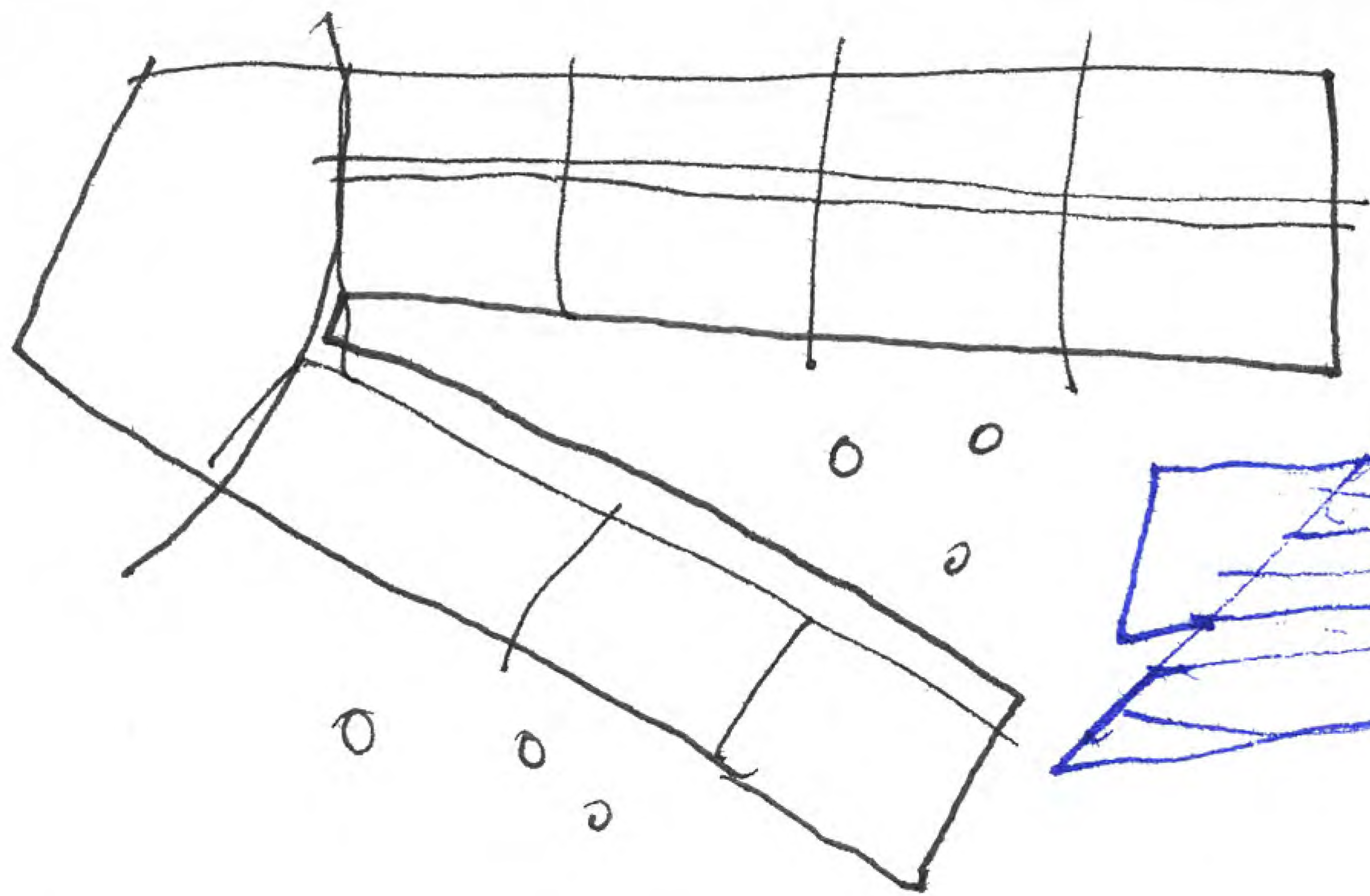

43

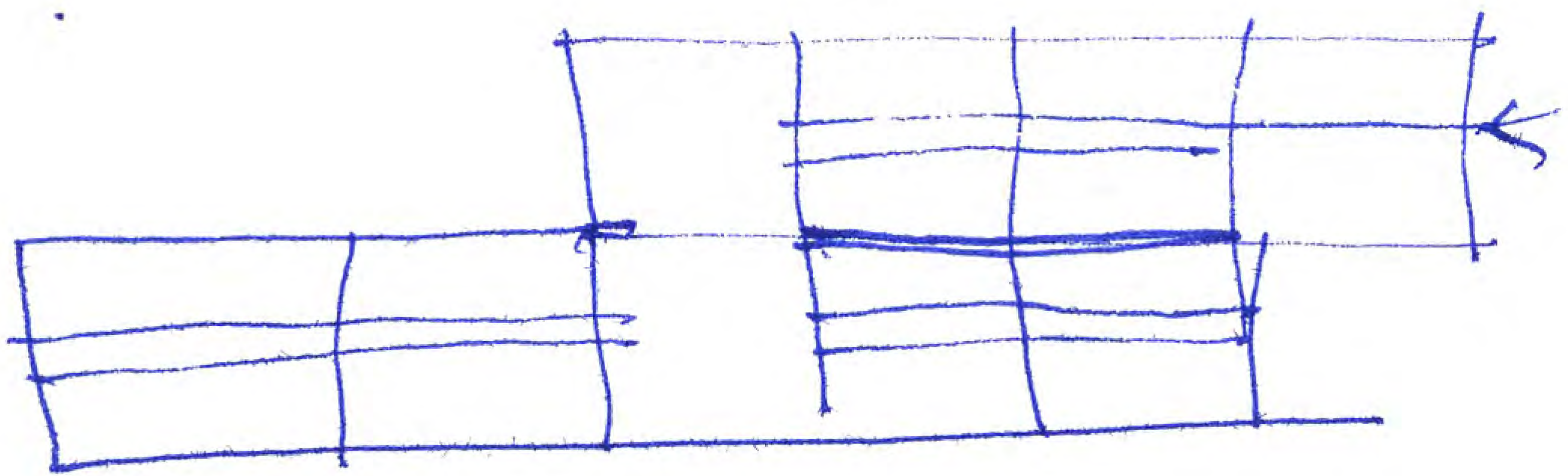

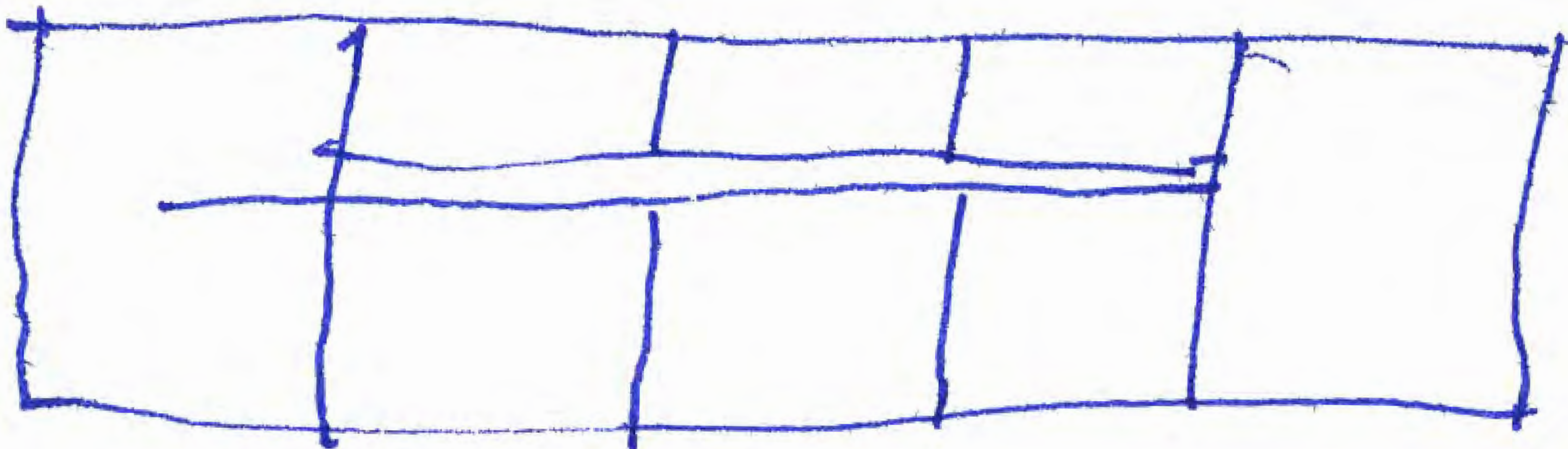

100m

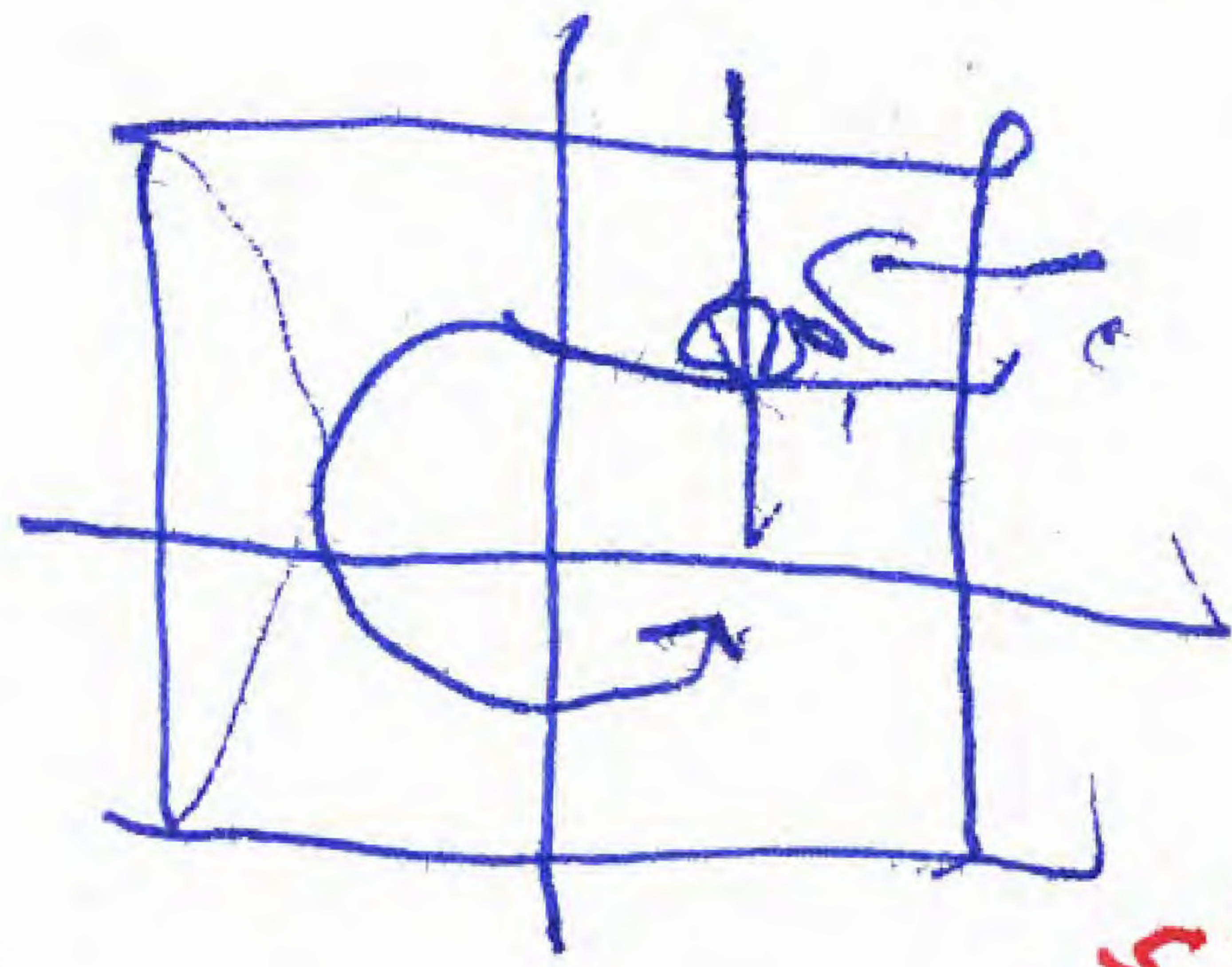
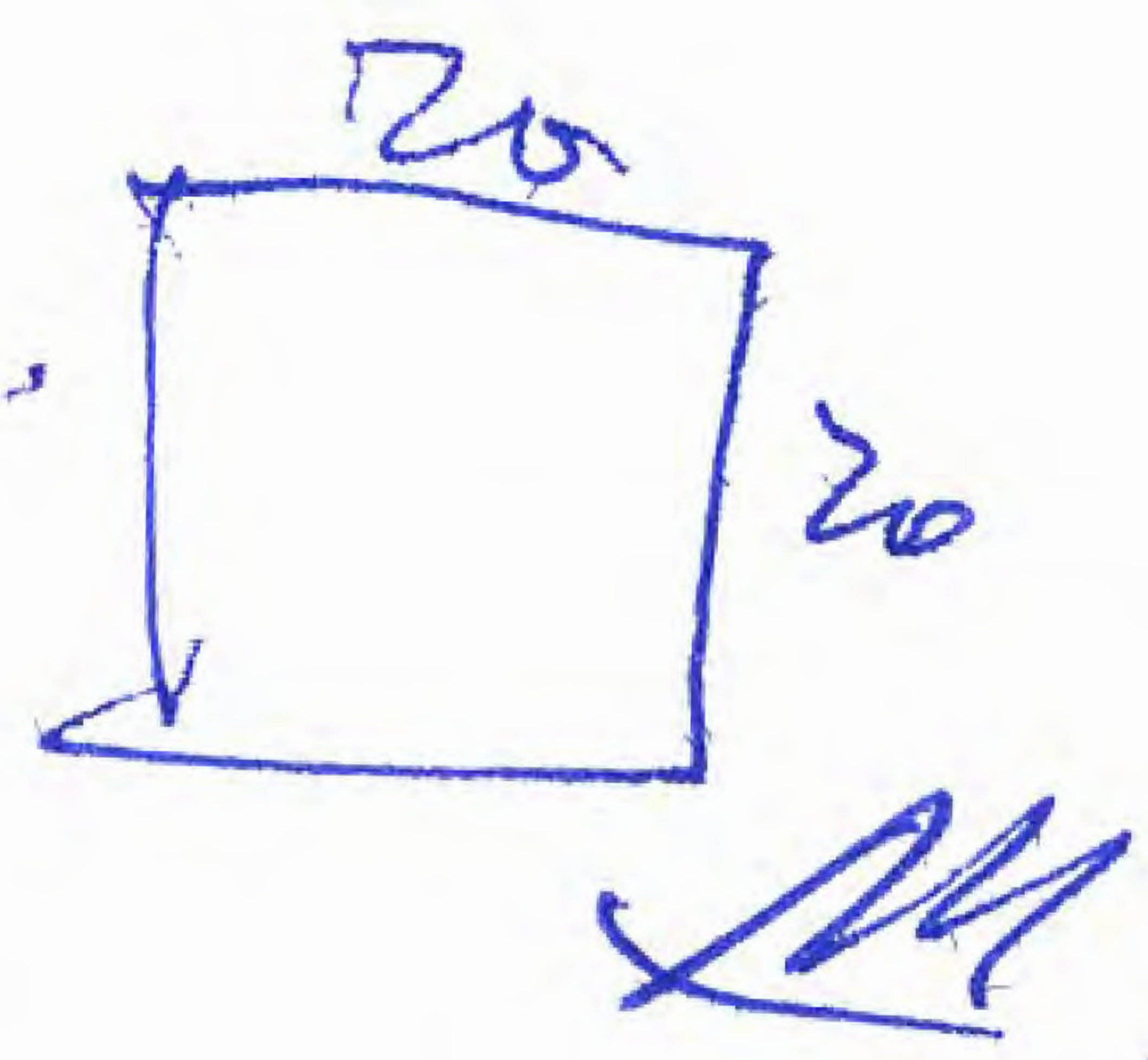
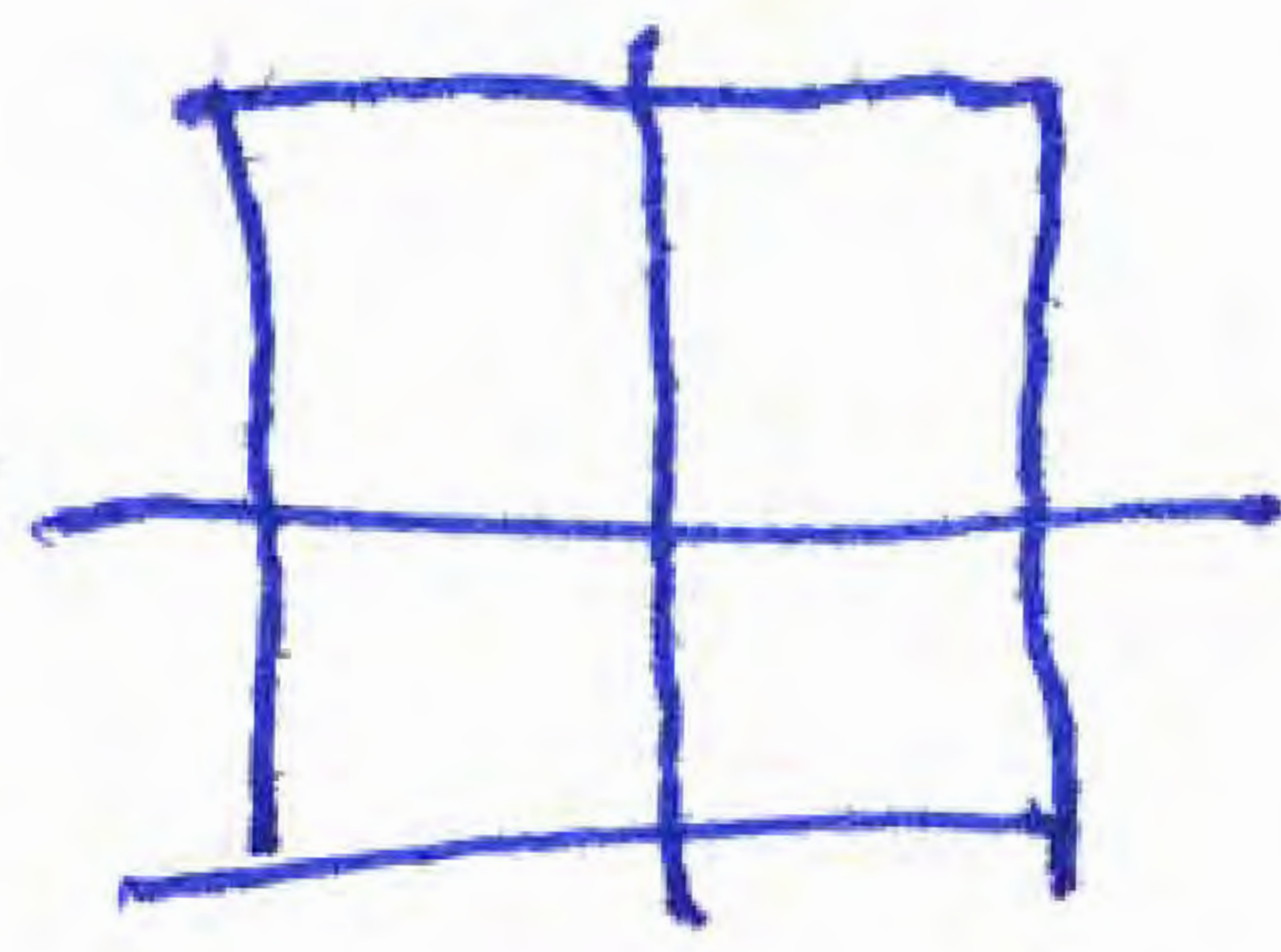
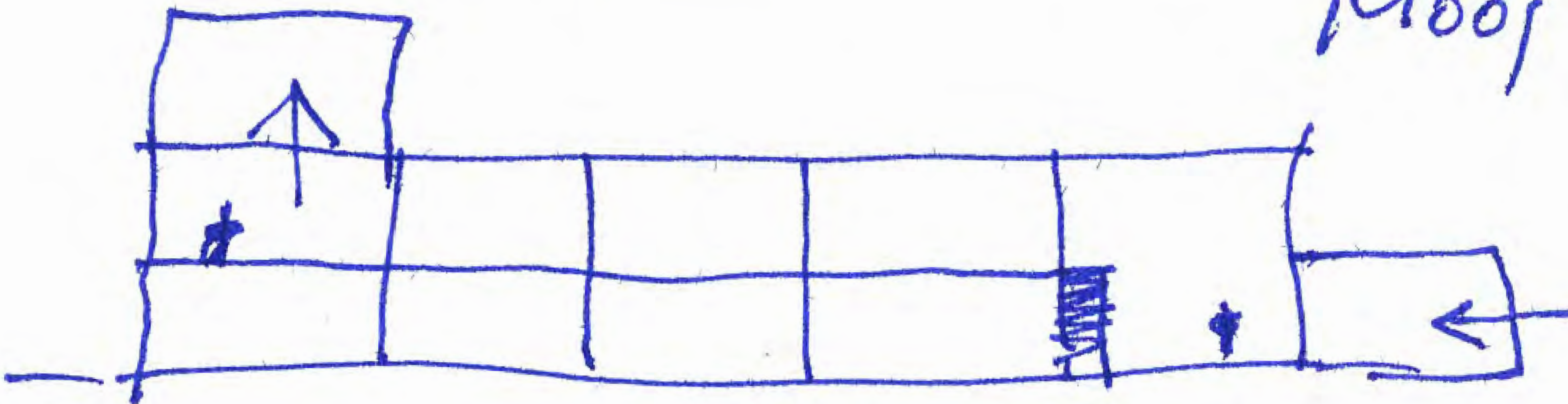

54 19 dic 2010.

M005

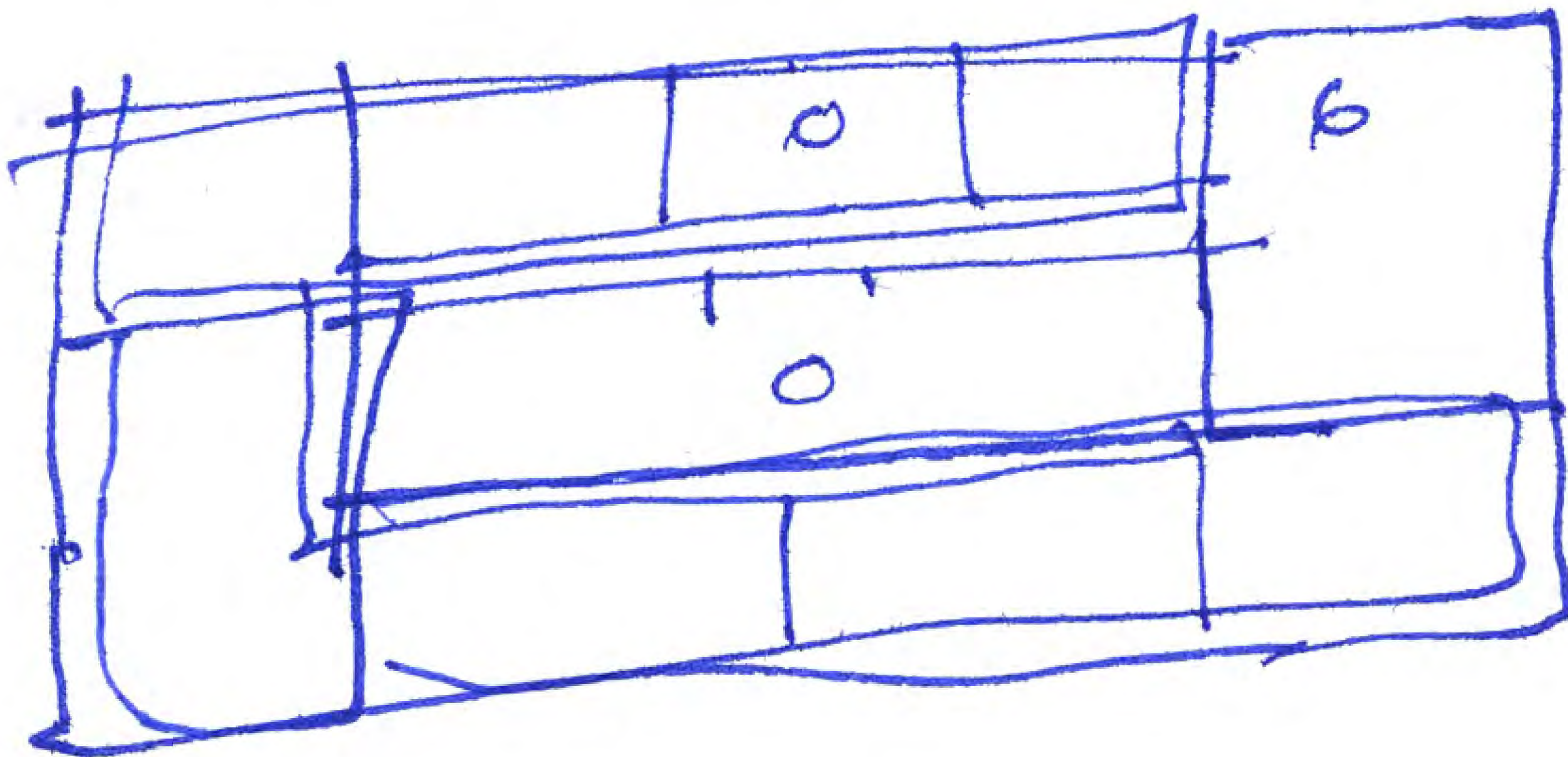
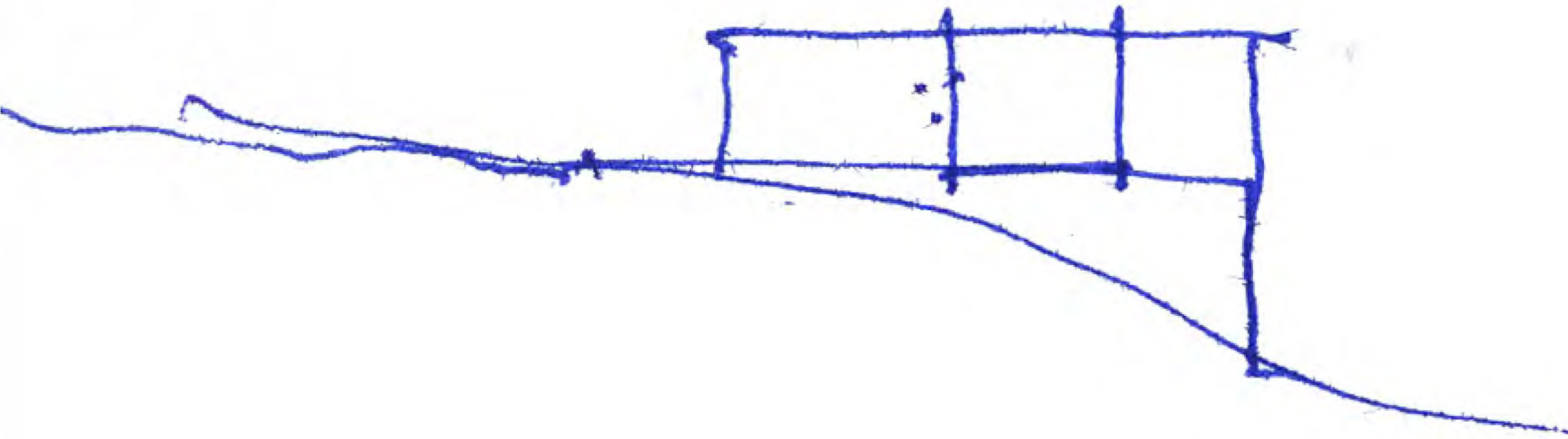

45

M005

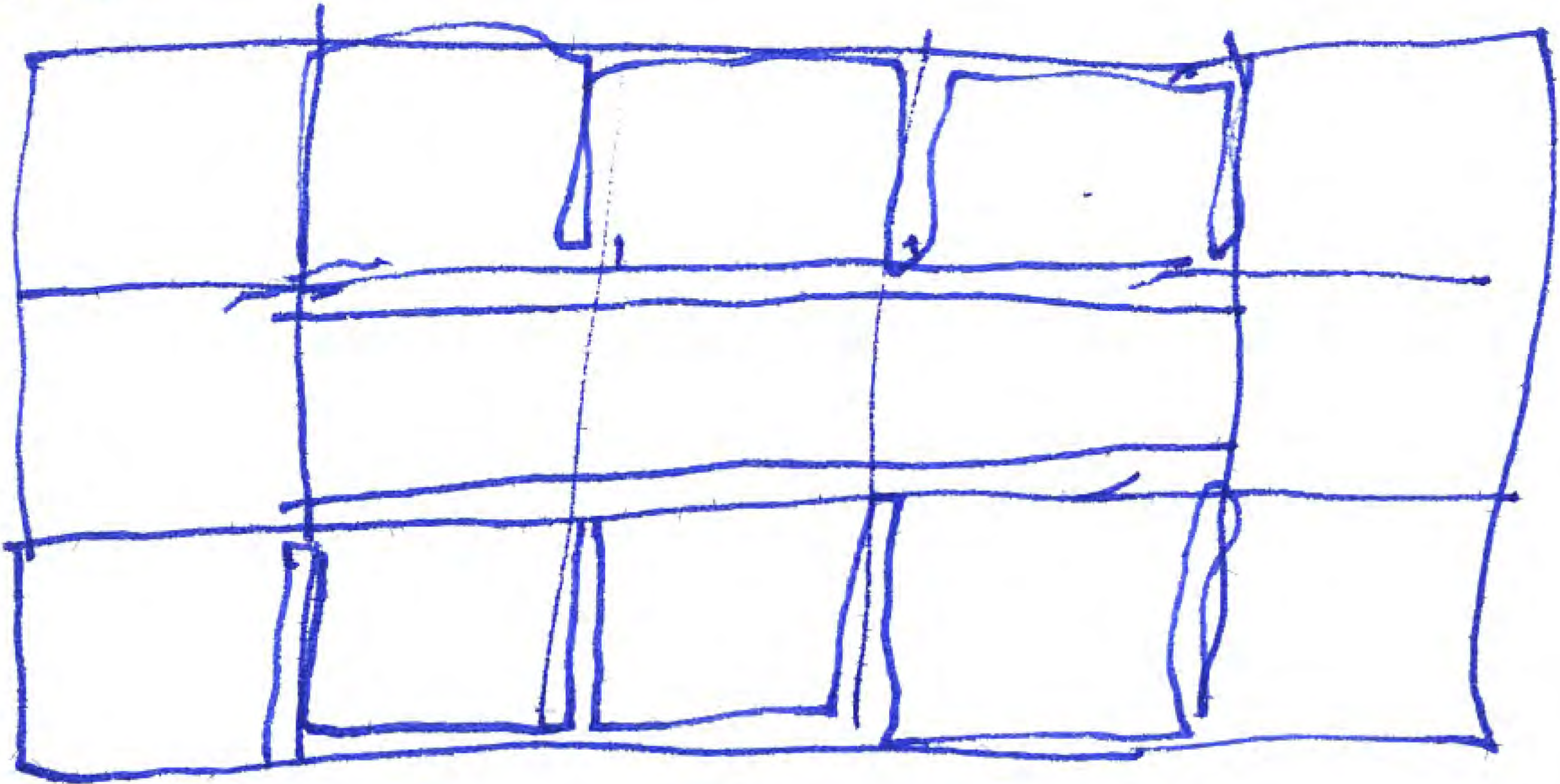

12

1

46

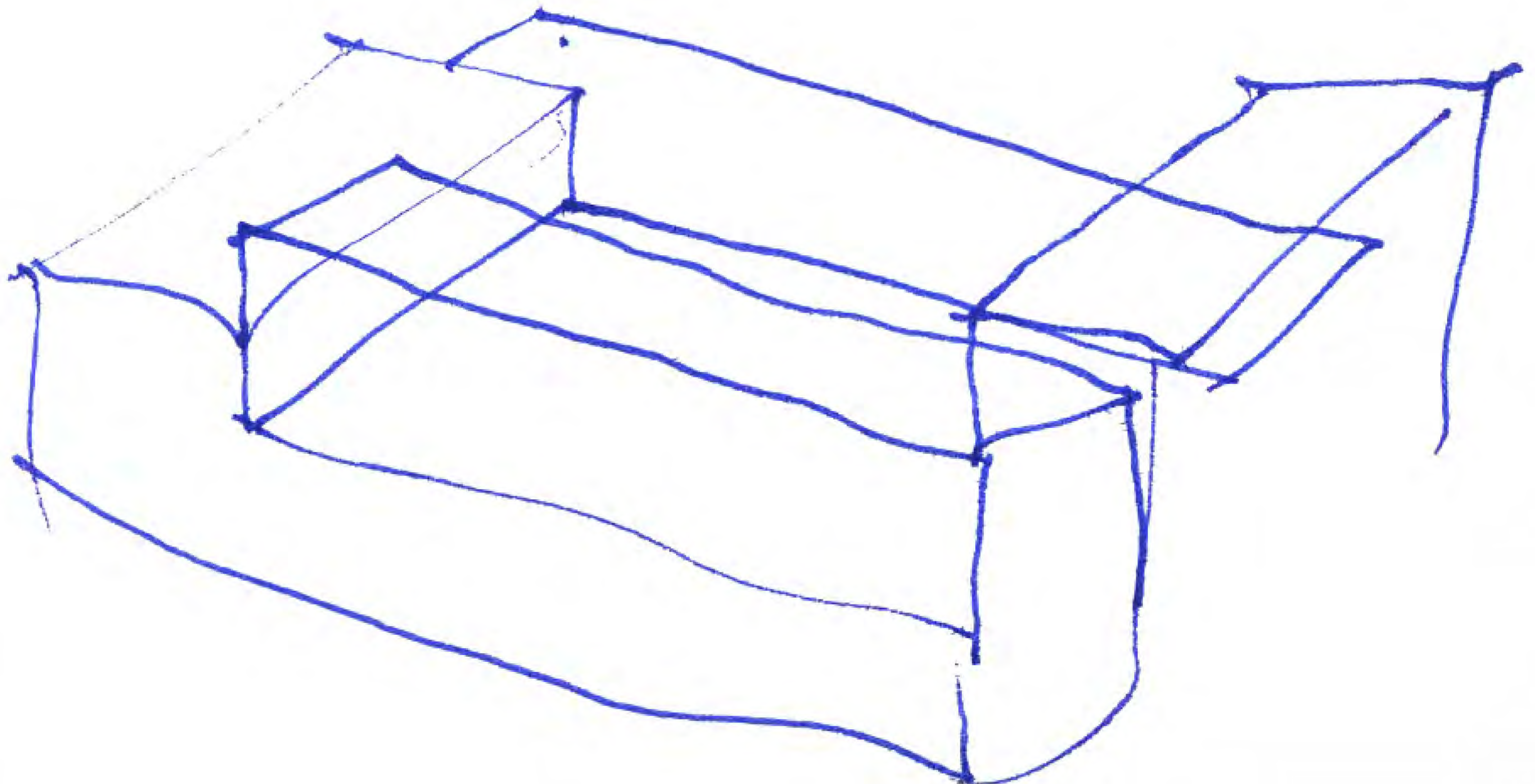



MOOS

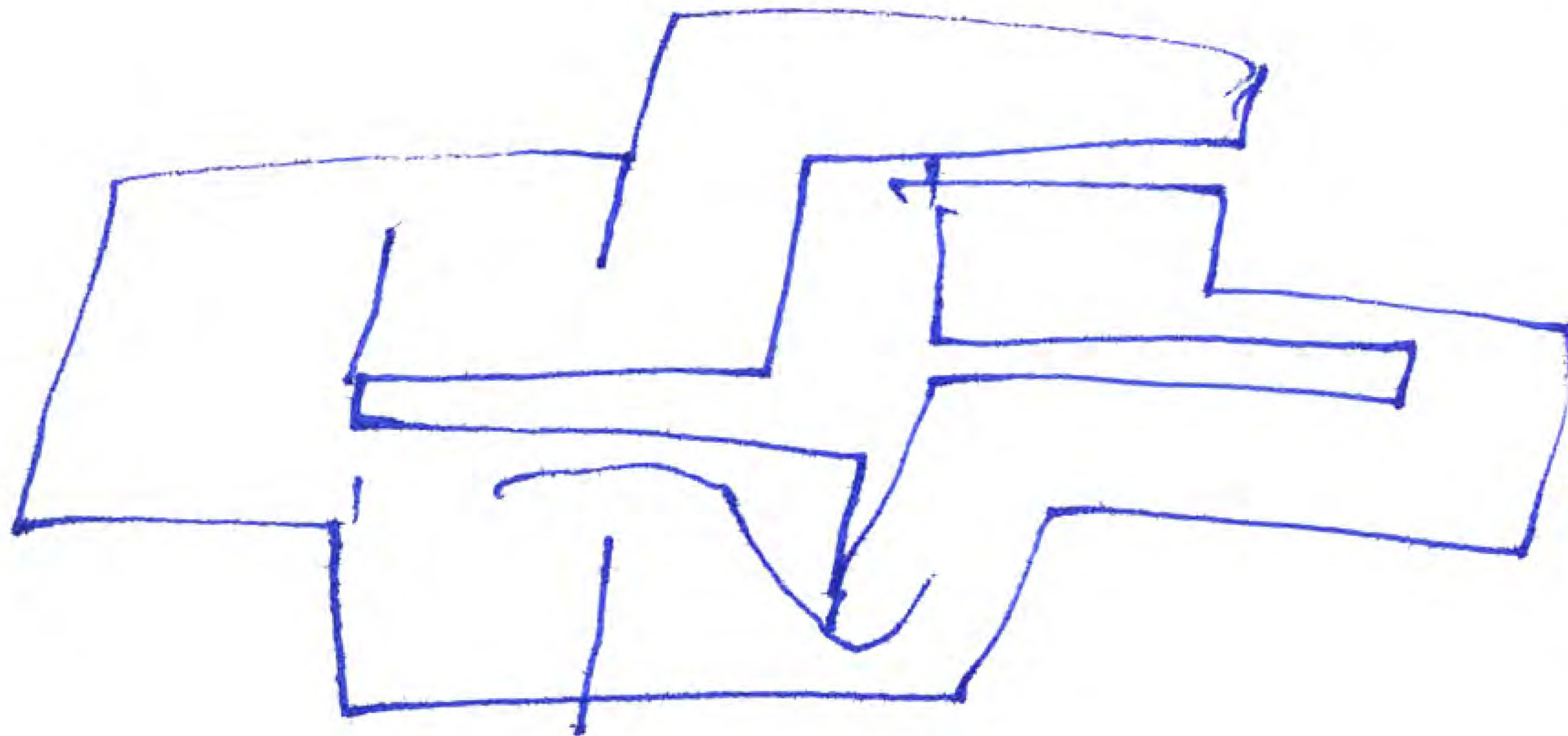

47

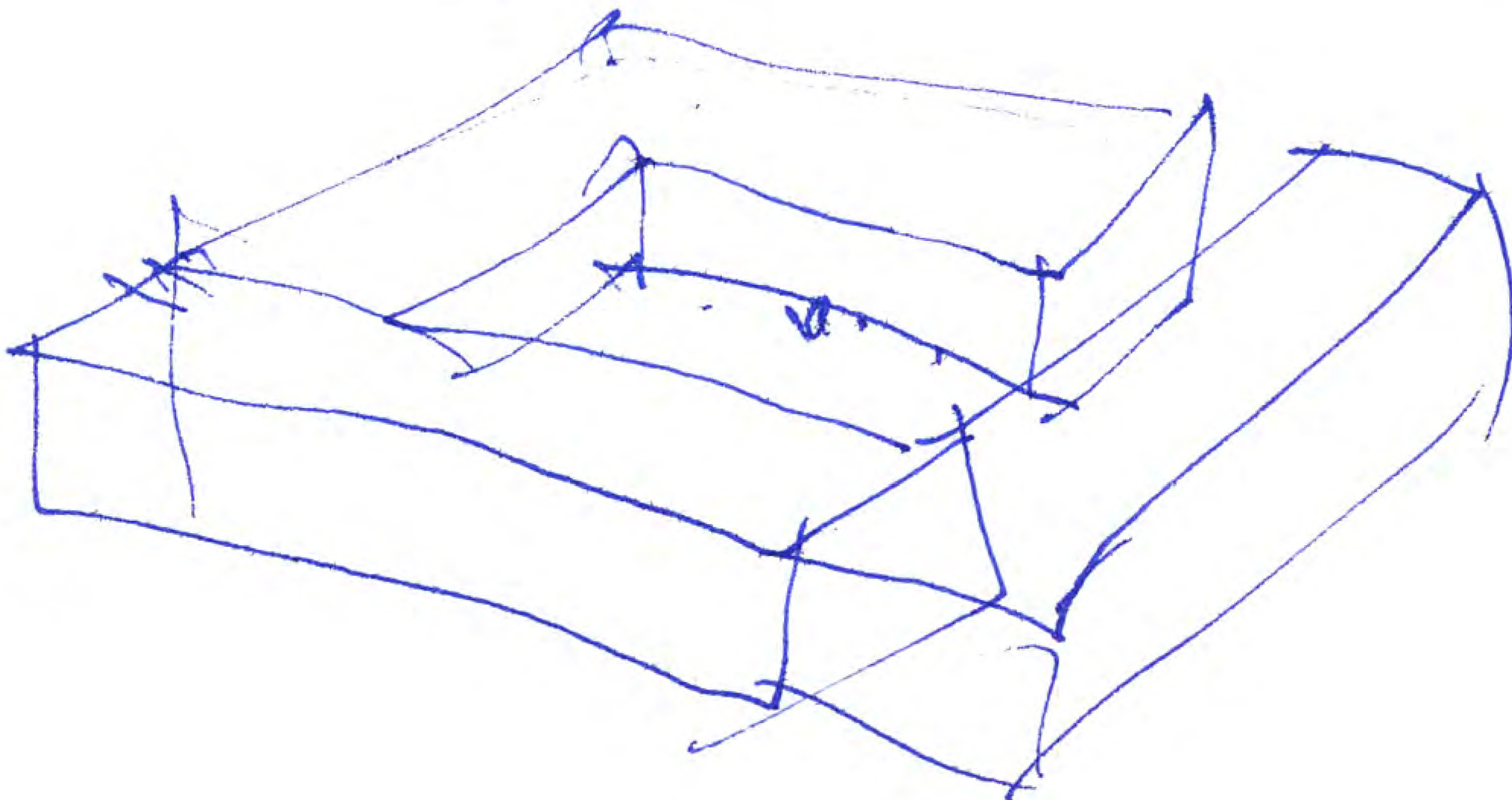

1005

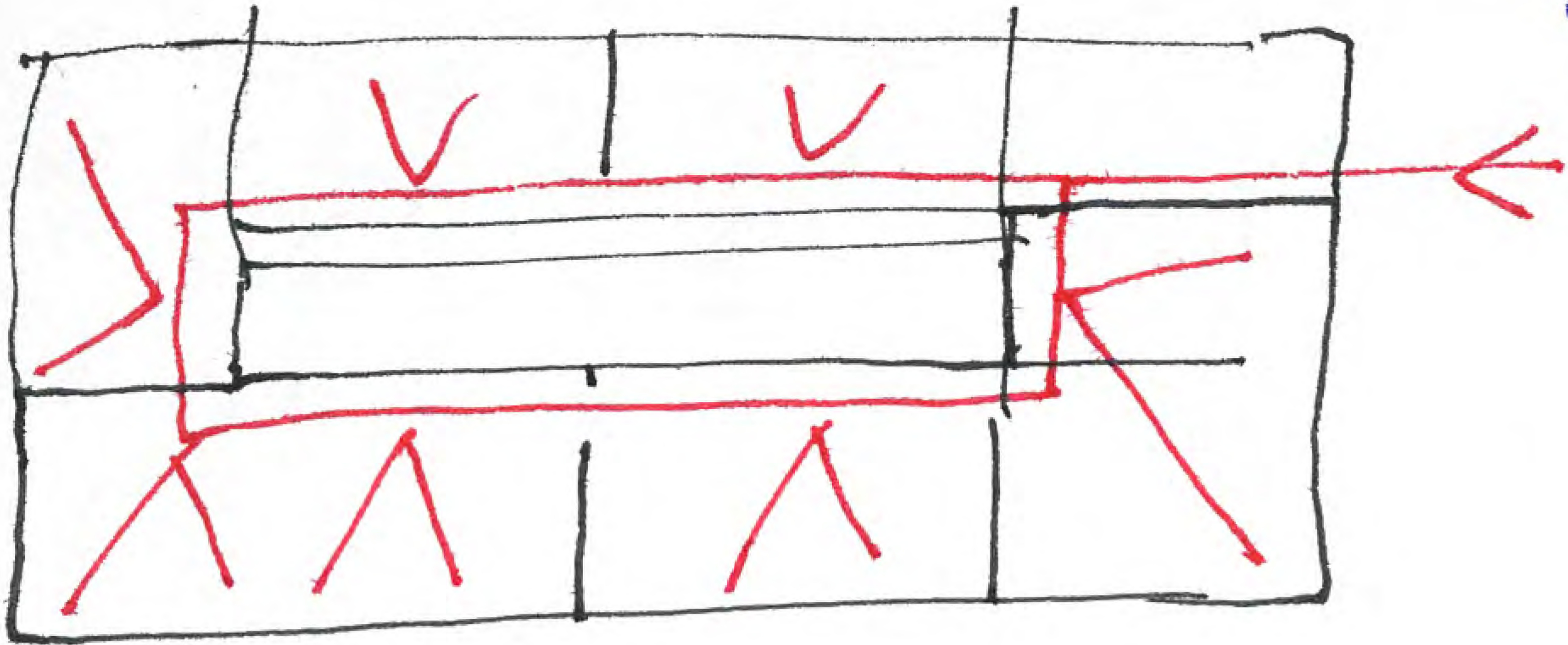

49

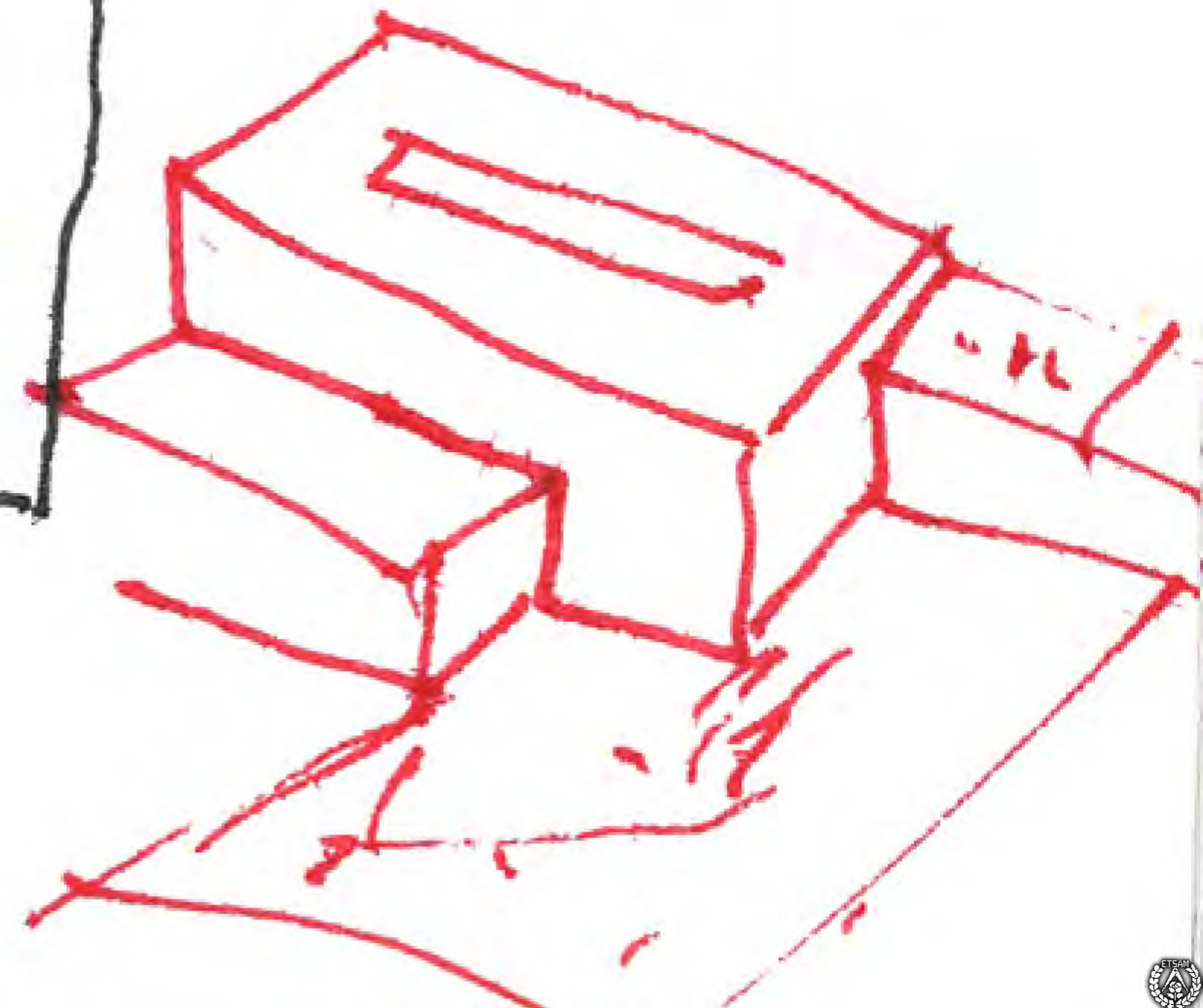
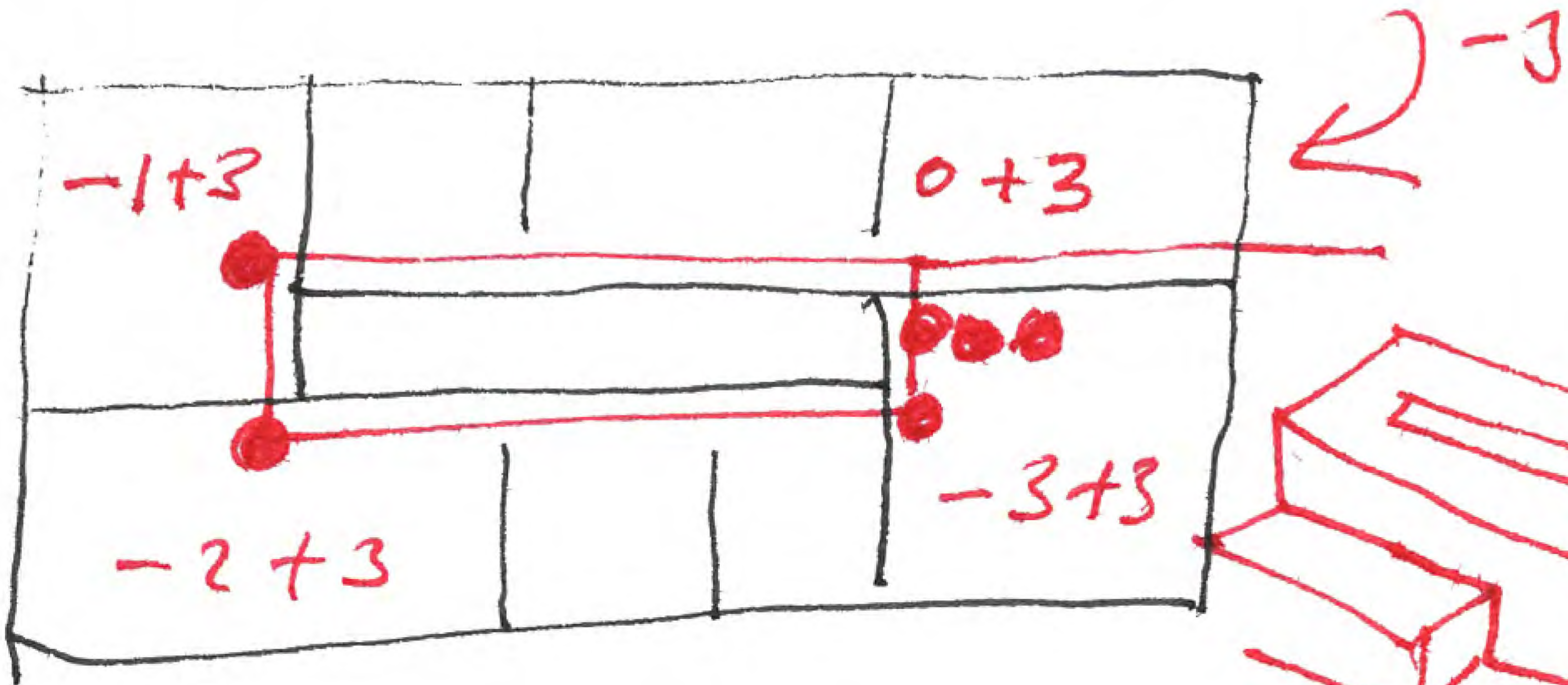

For the 5 meters 20 de la fonda.

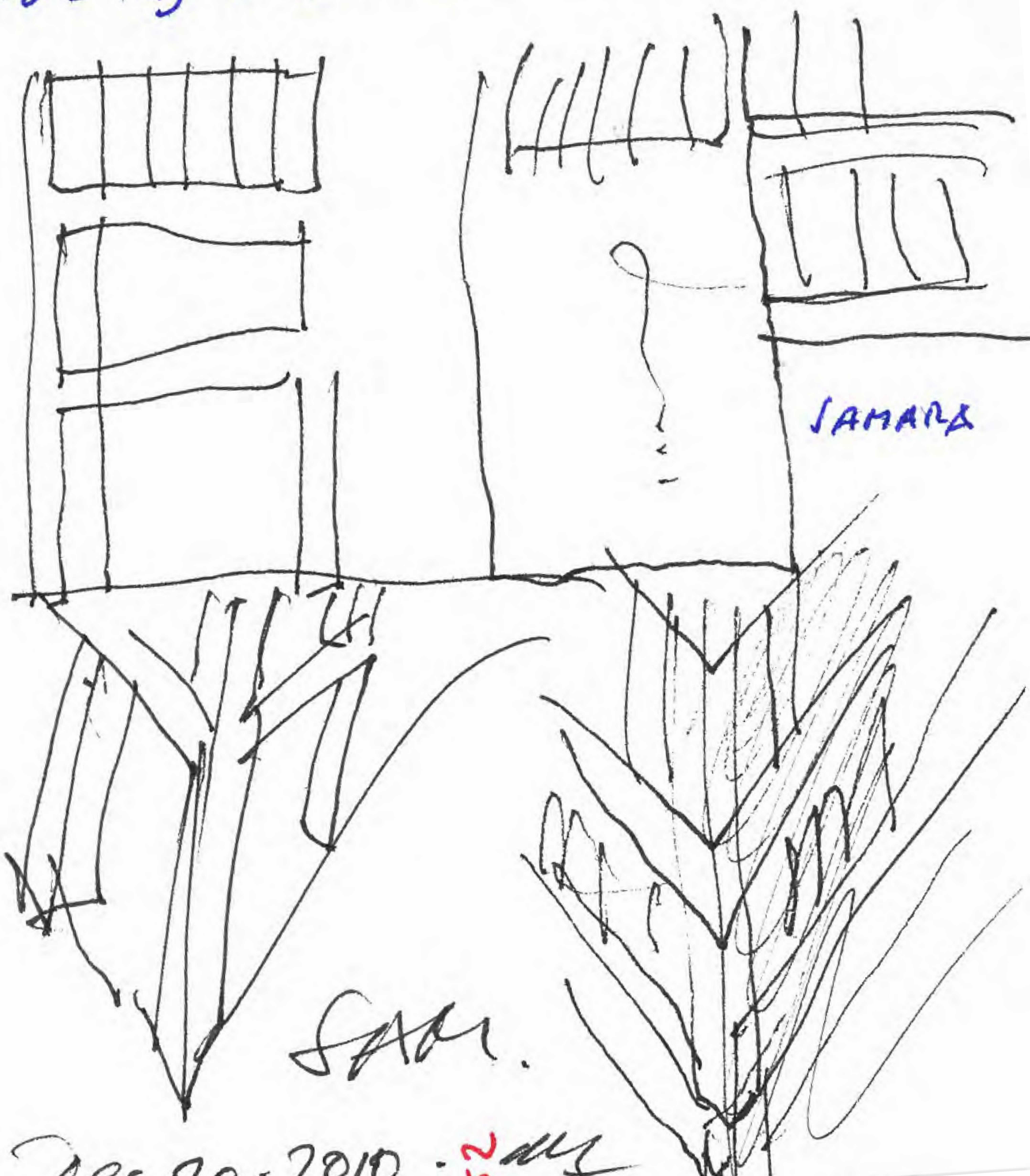

JAMARA

SADA

Dec-20-2010 - 52 m

MOOS

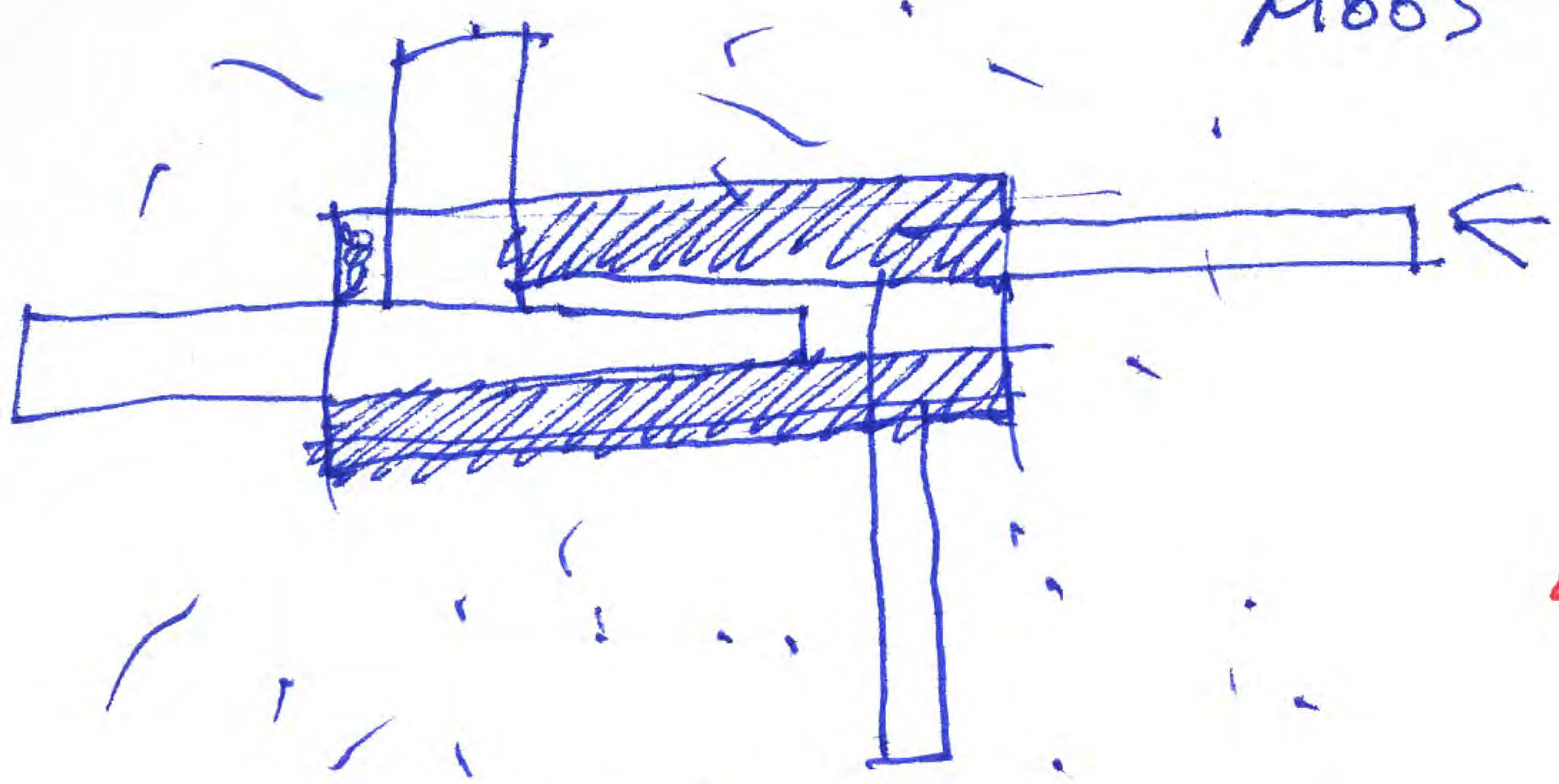

55

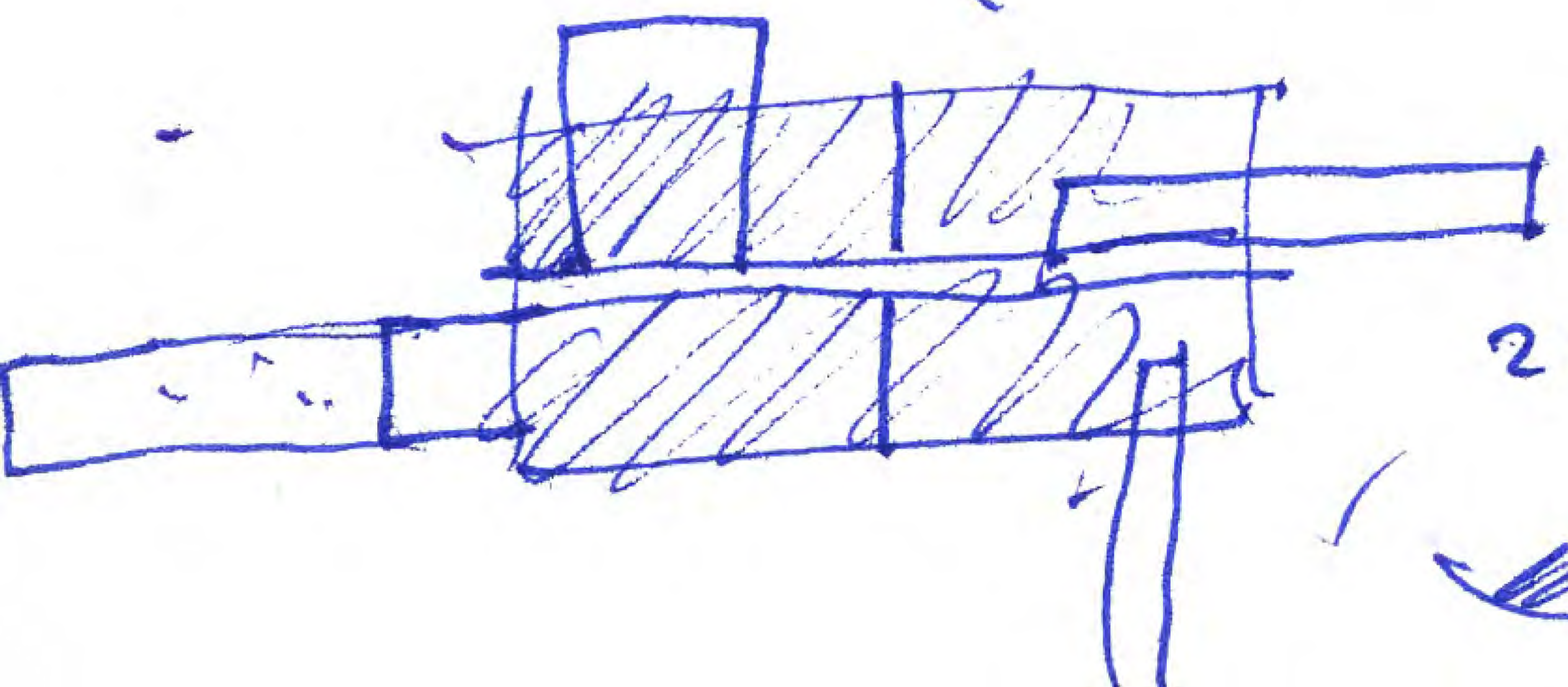

21 dic 2010

VT

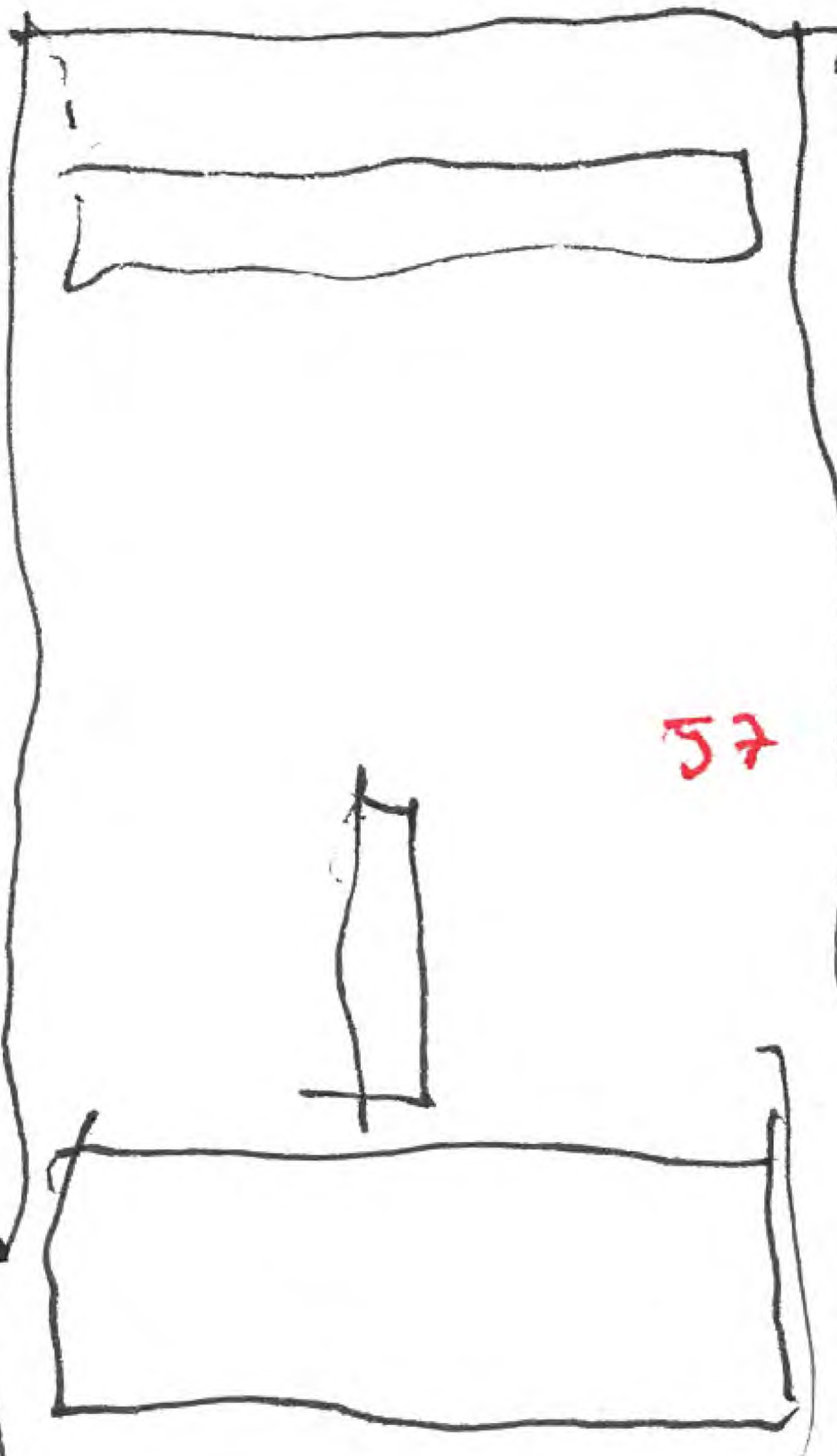
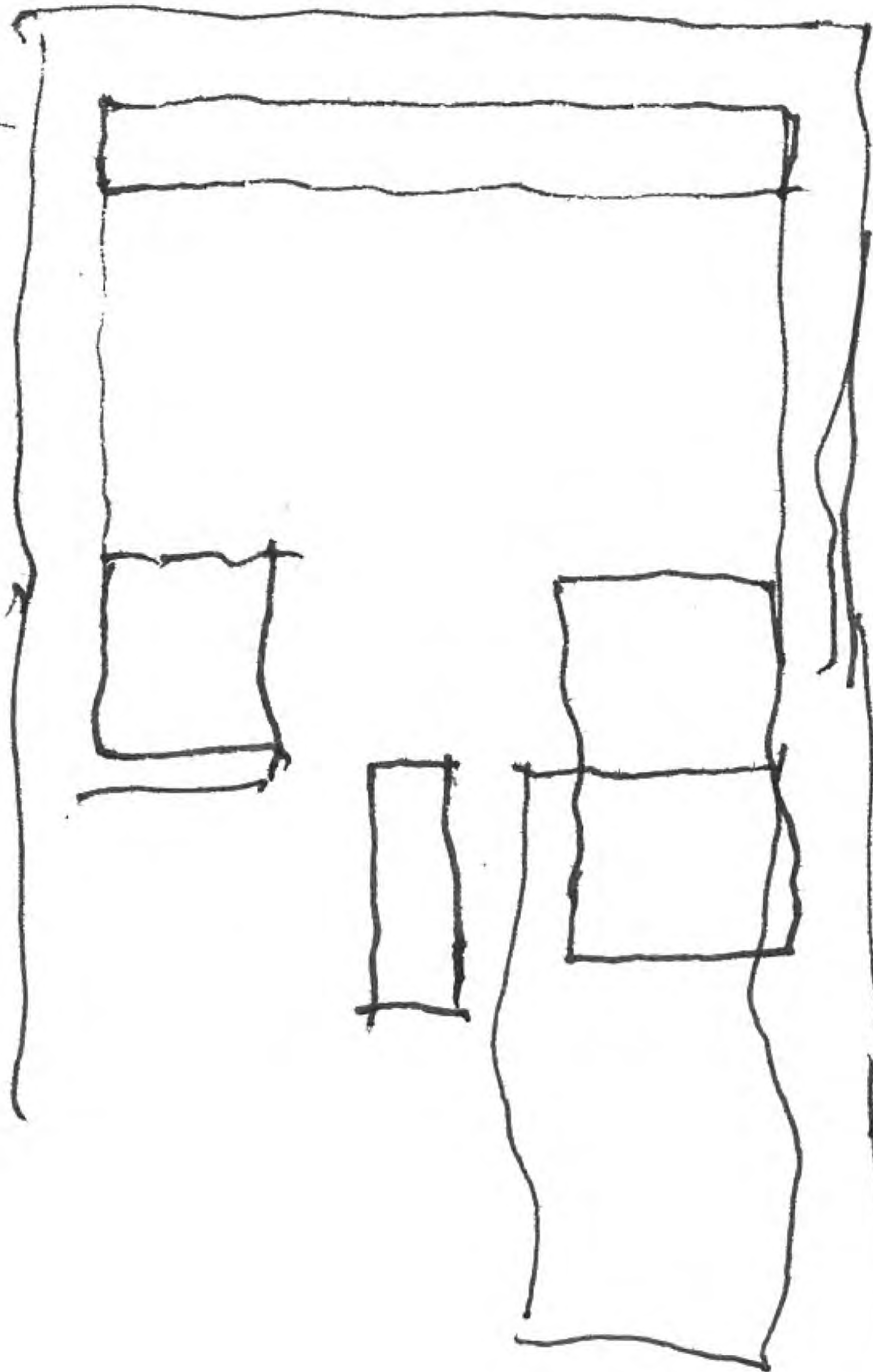

57

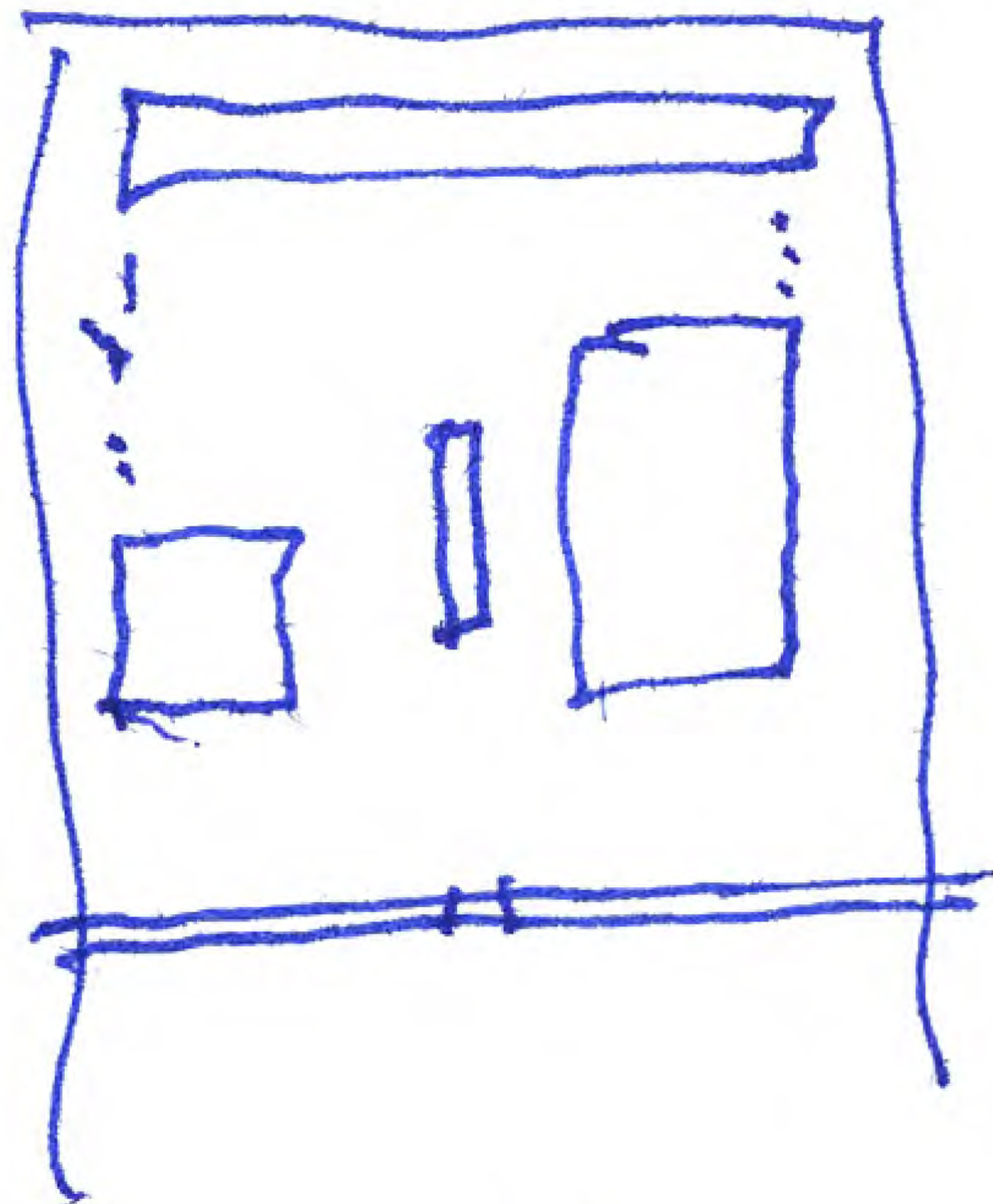
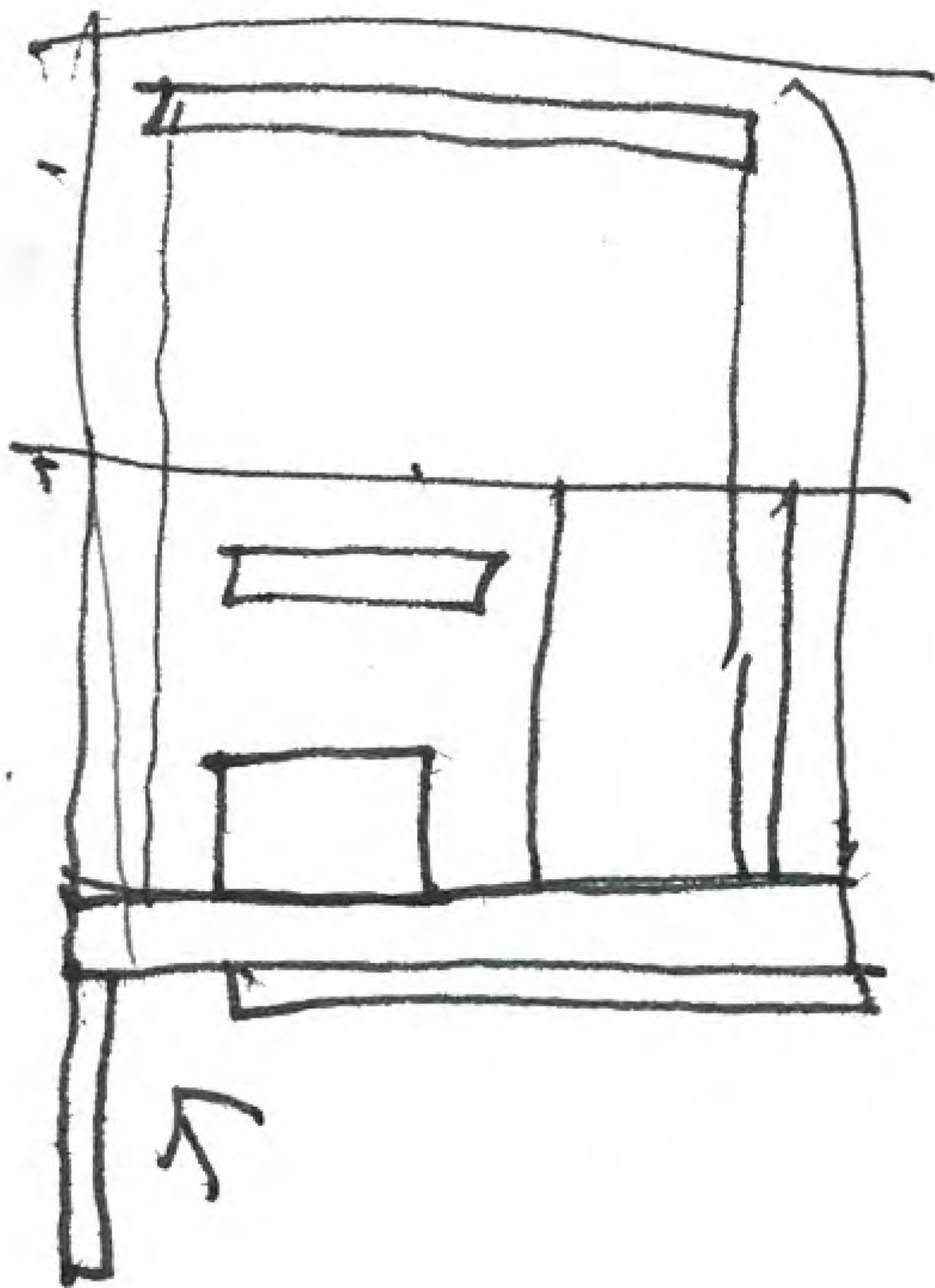

VT

65

à Genève

le 22  
decembre

2010

MOOS

1955

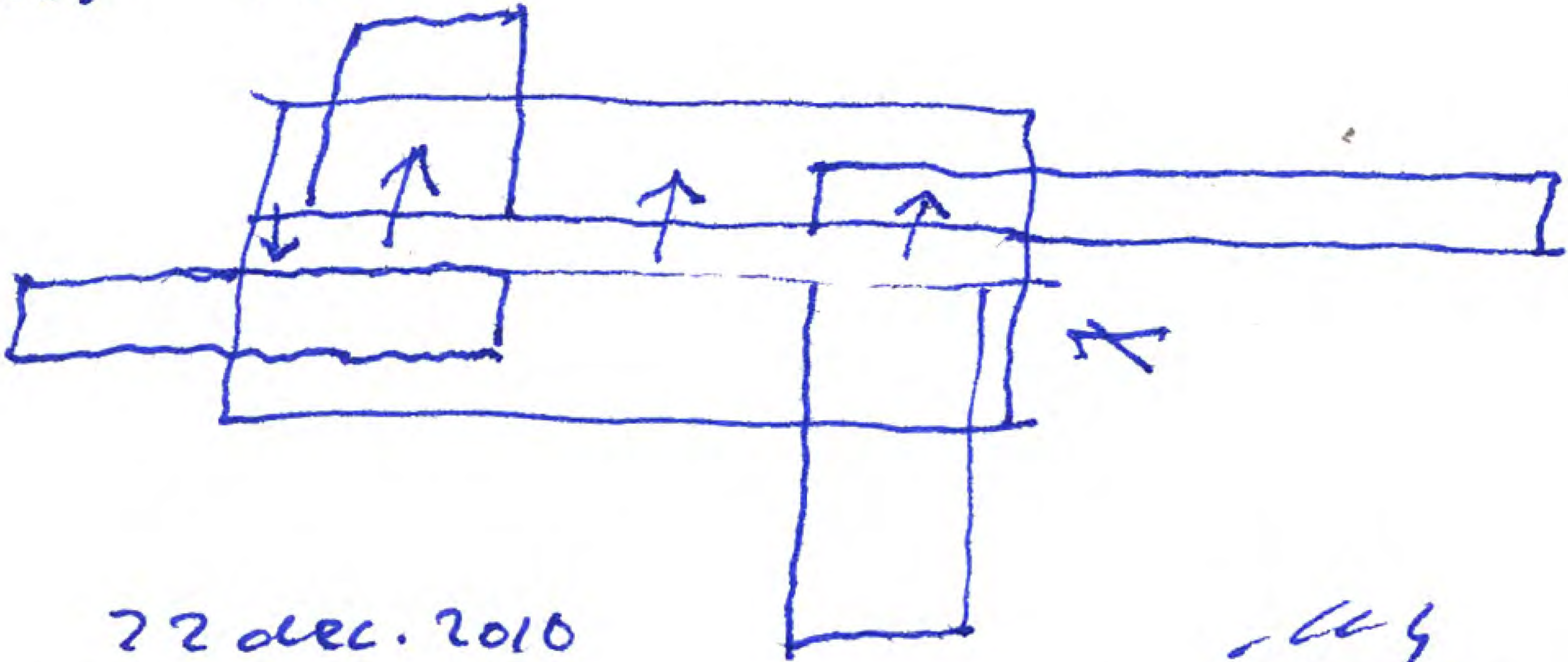

22 dec. 2010

llg

76

M005

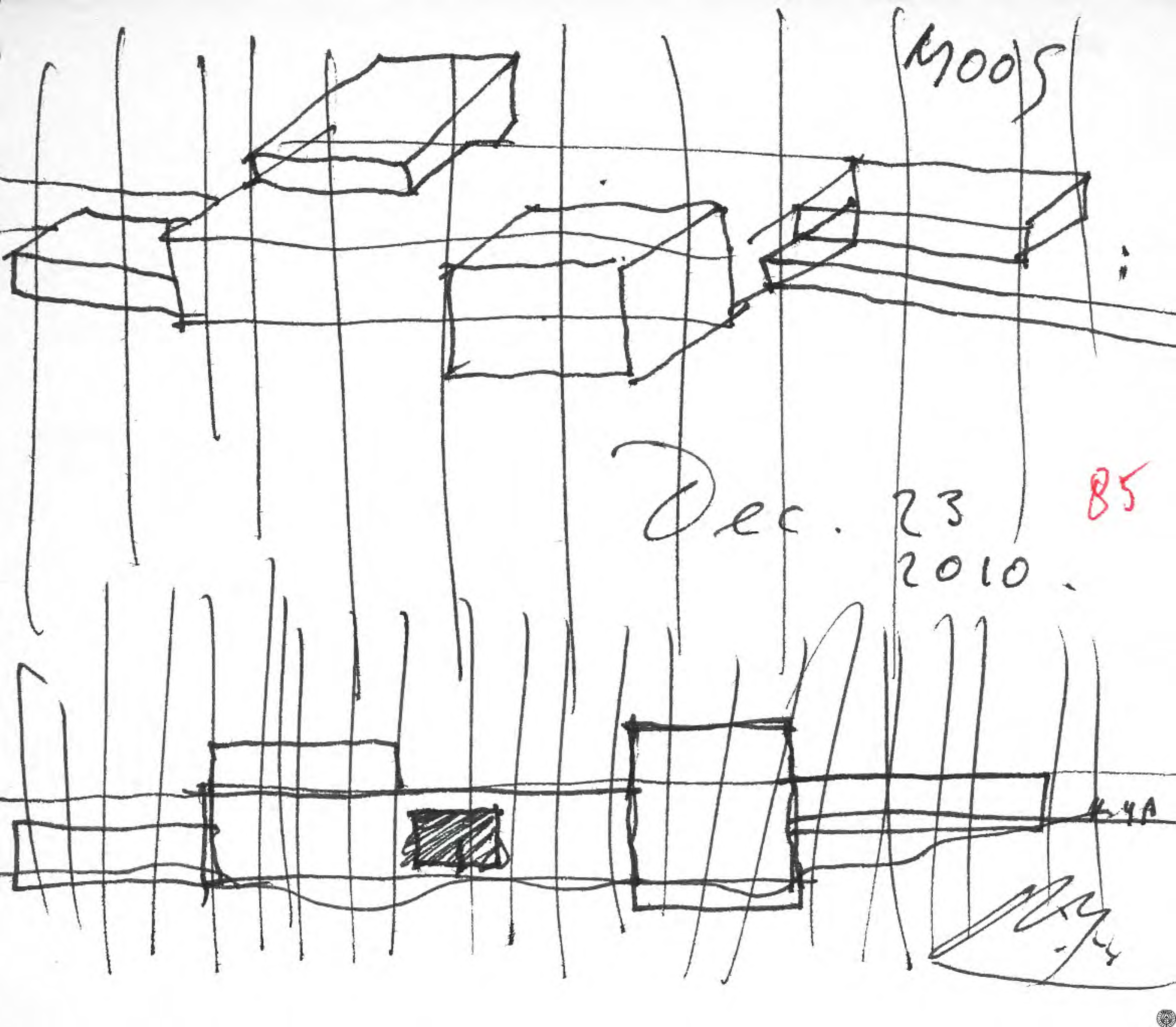

Dec. 23  
2010

85

K-4A

Handwritten signature or initials, possibly "M. J. 4".



M005

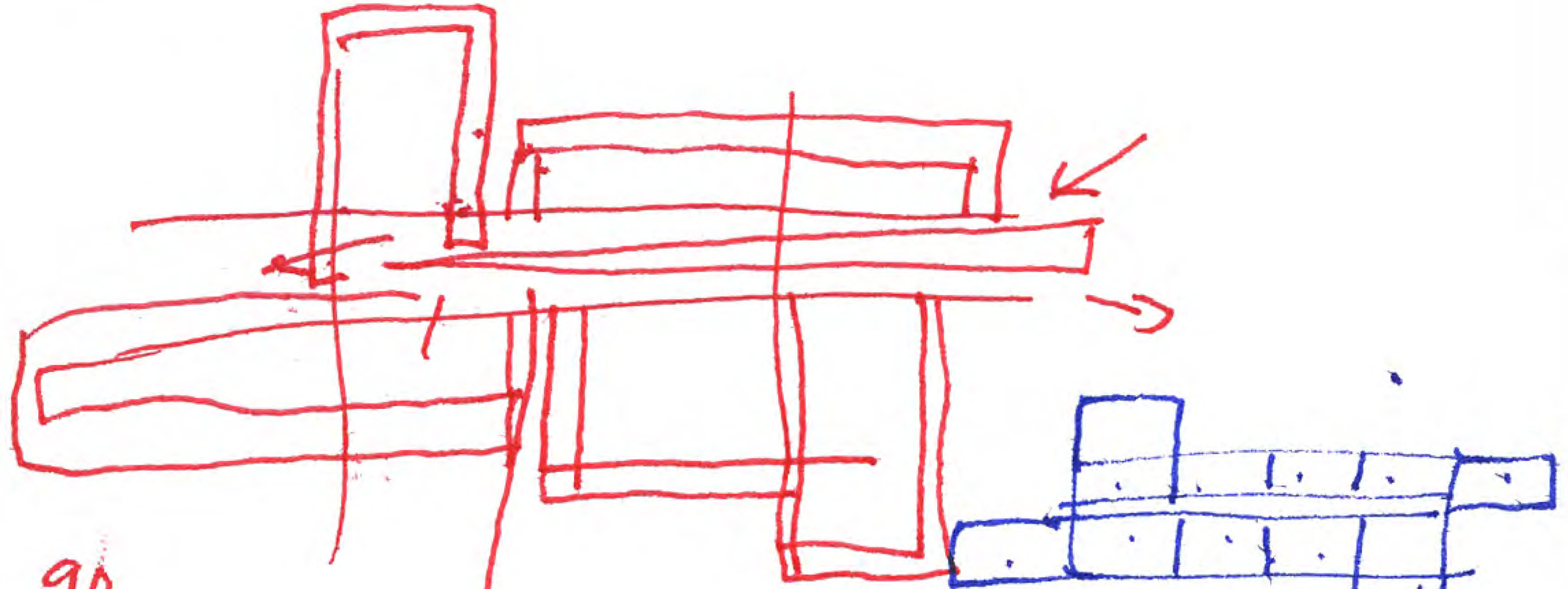

90

10 Salats

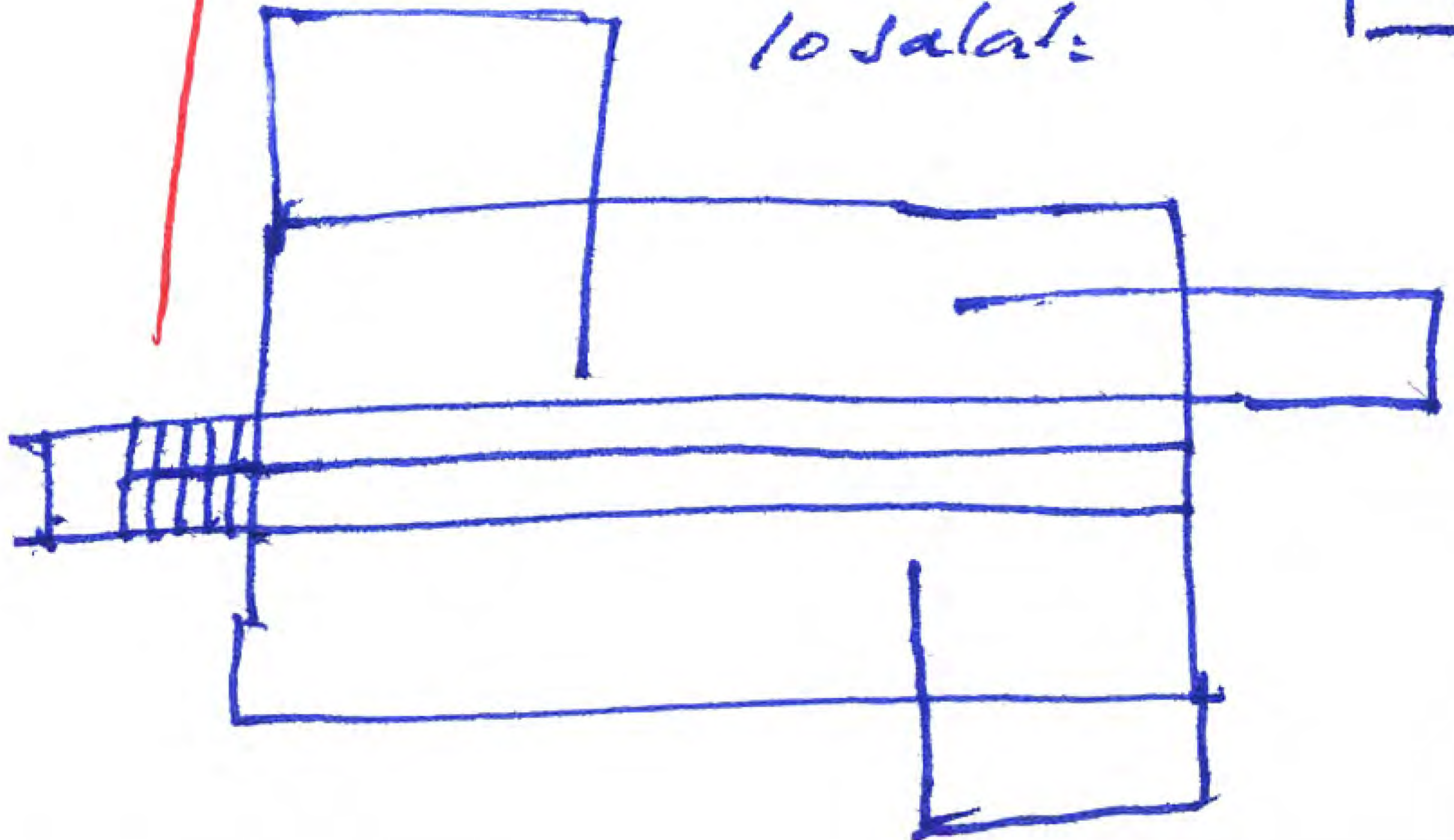

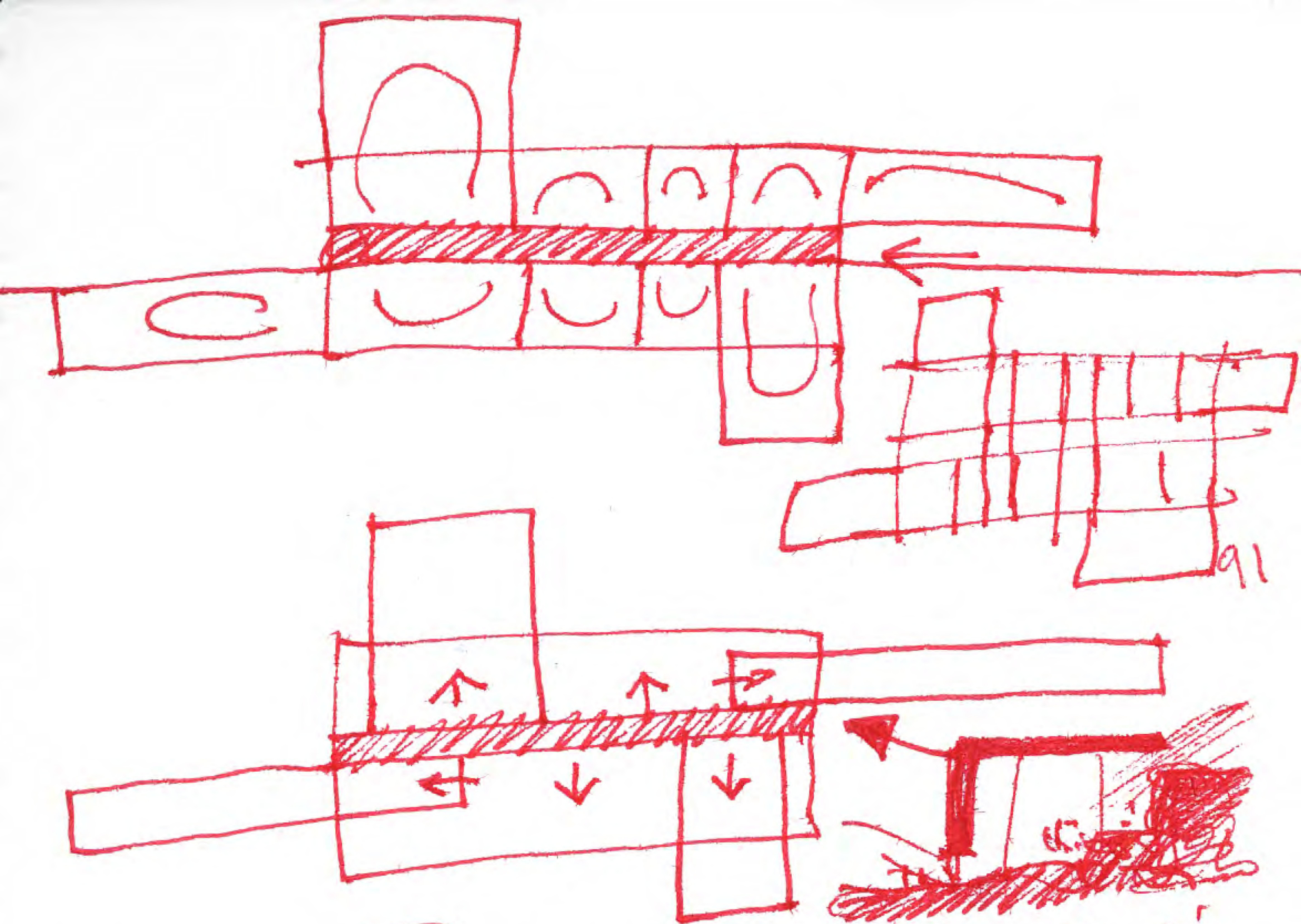

MOOS [ continuidad en la circulación  
 un NATURAL adecuada.  
 espacio polivalente.

Moos

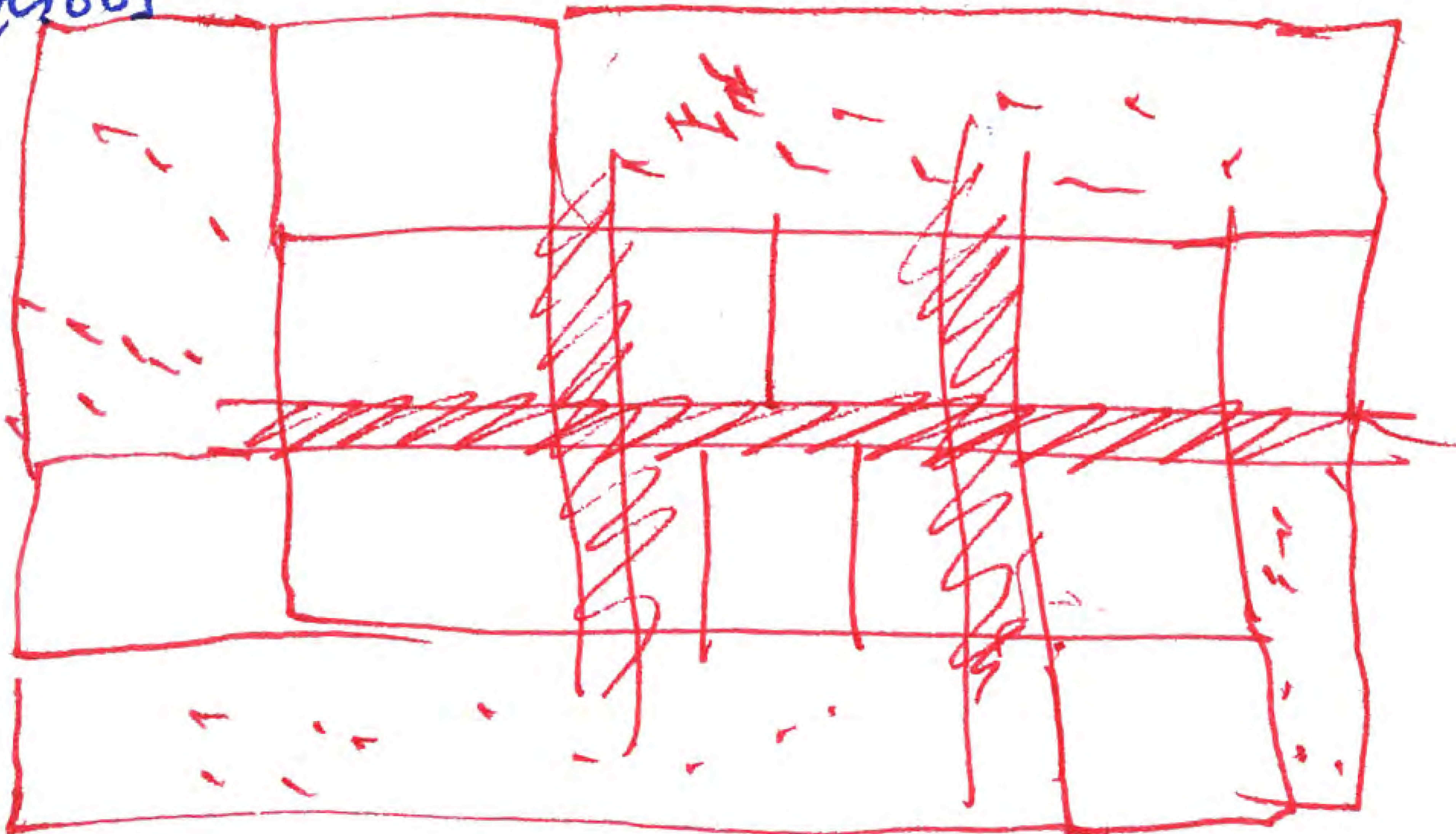

92

IN A WILD FLOWER

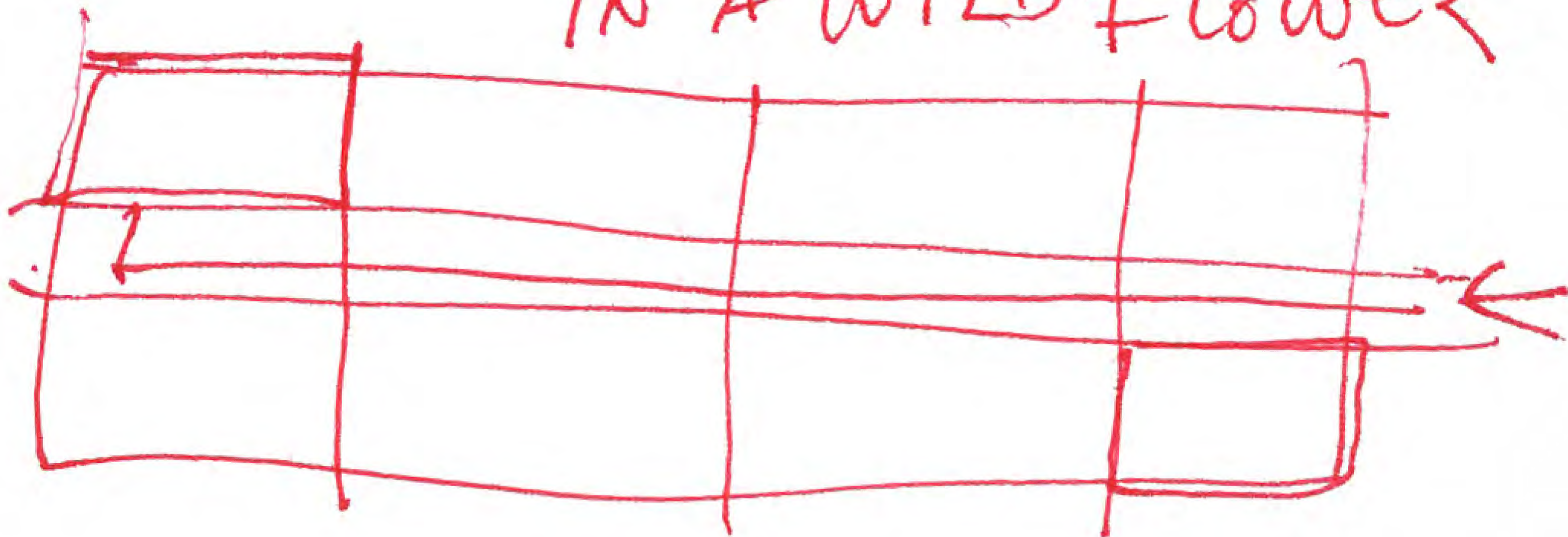

1005

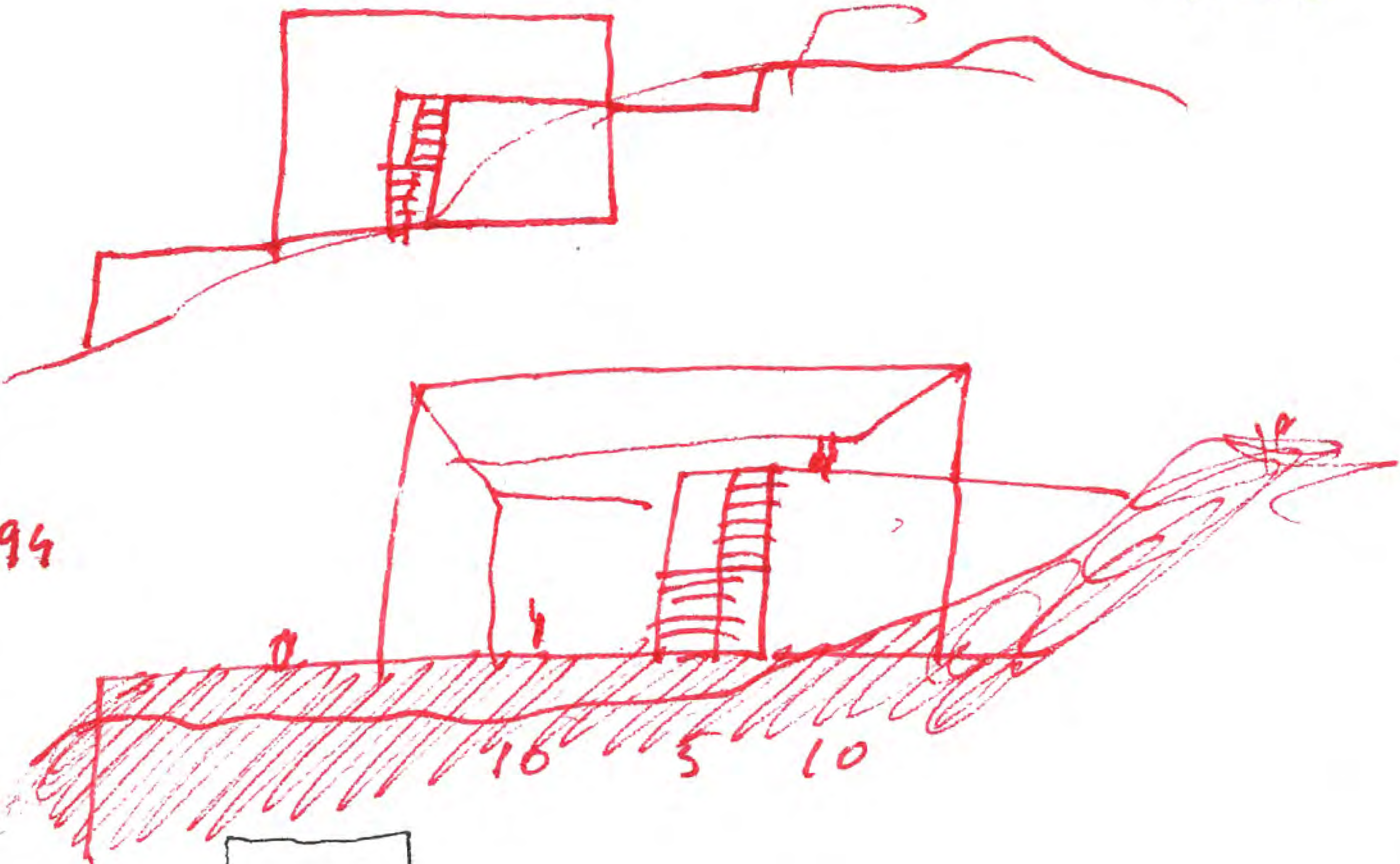

94

10 5 10

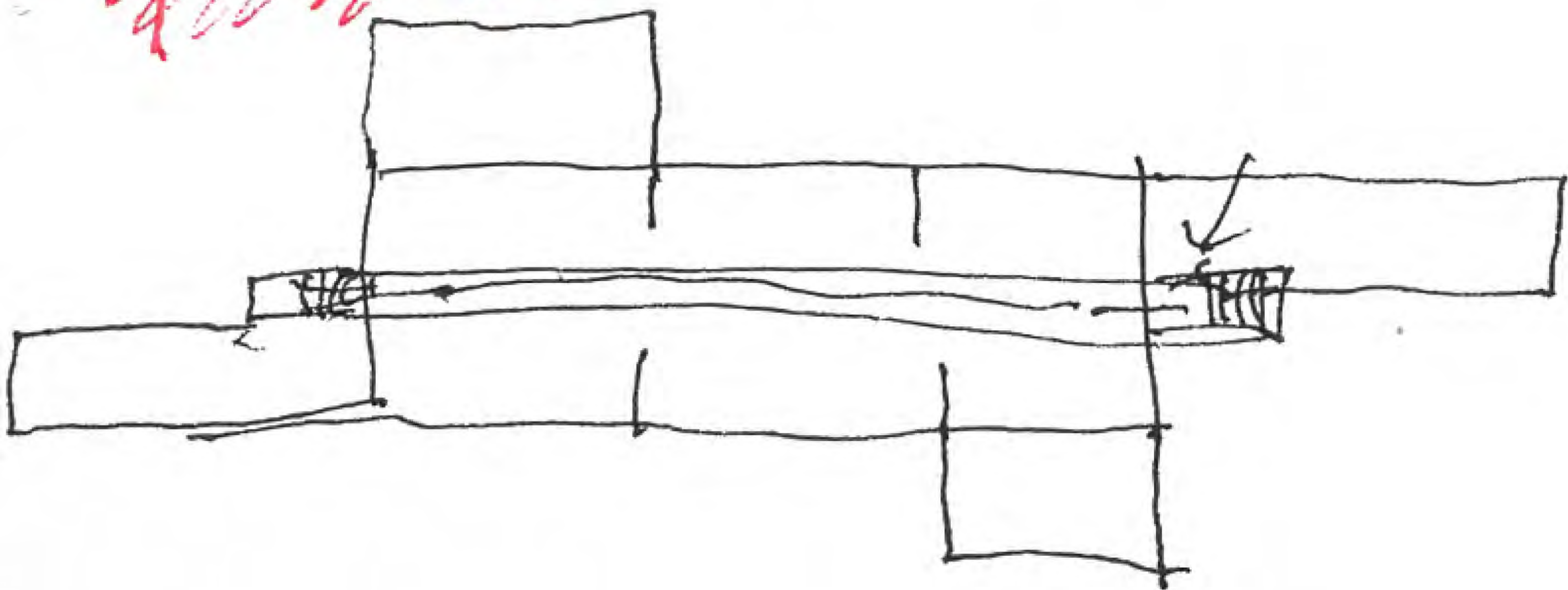

1000

30.

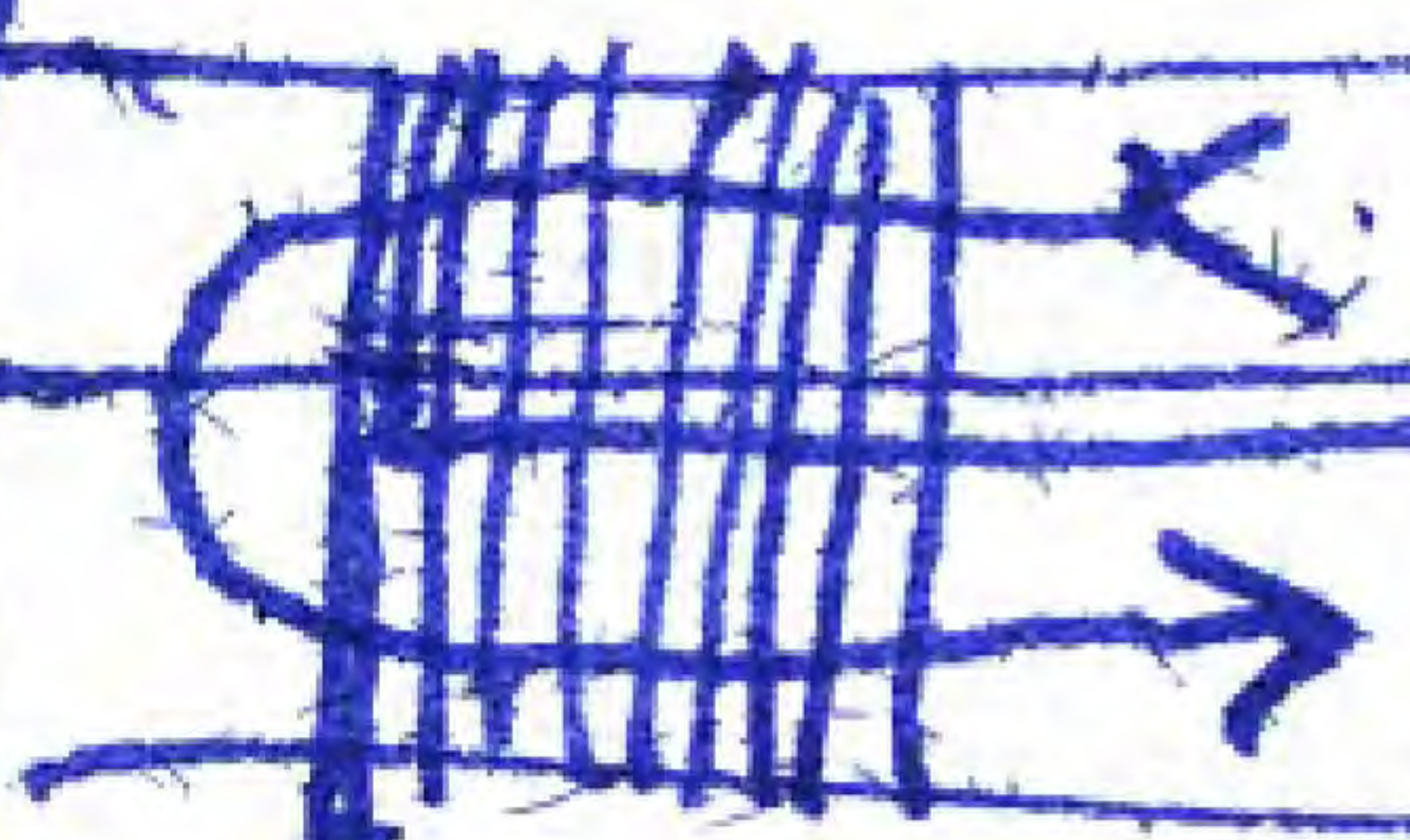

95

$$250. \rightarrow 3000 = 12.$$

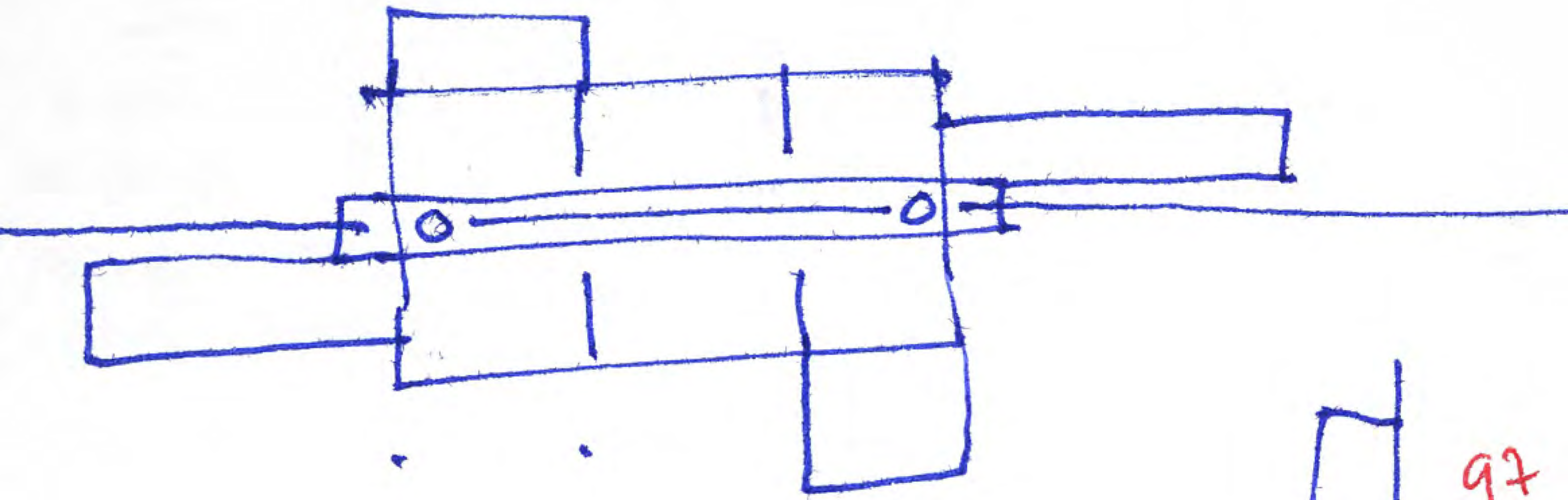

97



M005

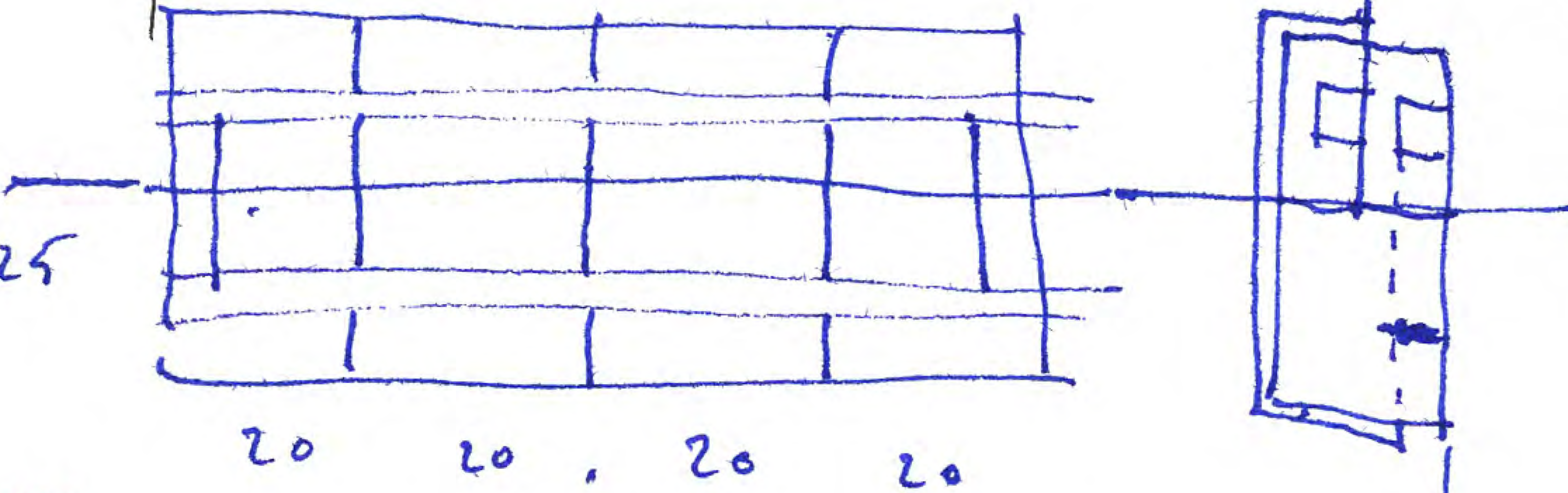

100

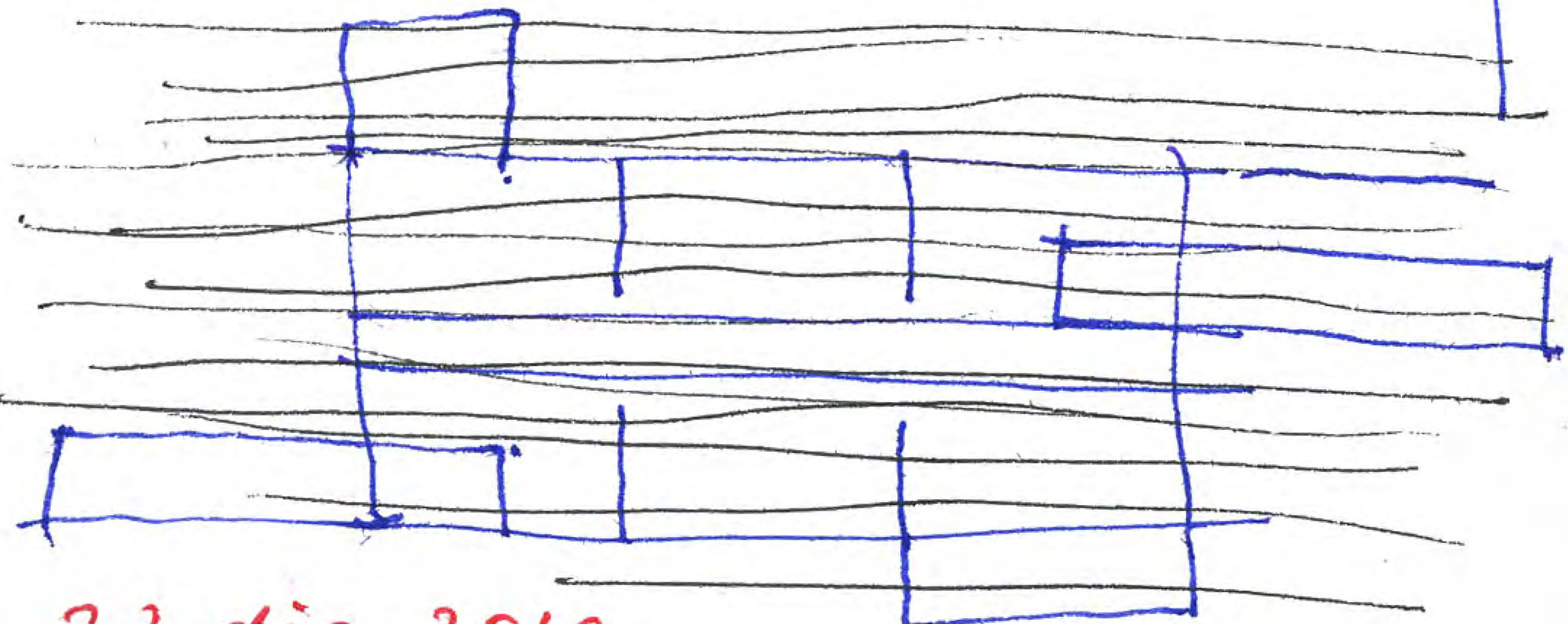

27 dic. 2010.

MOOS

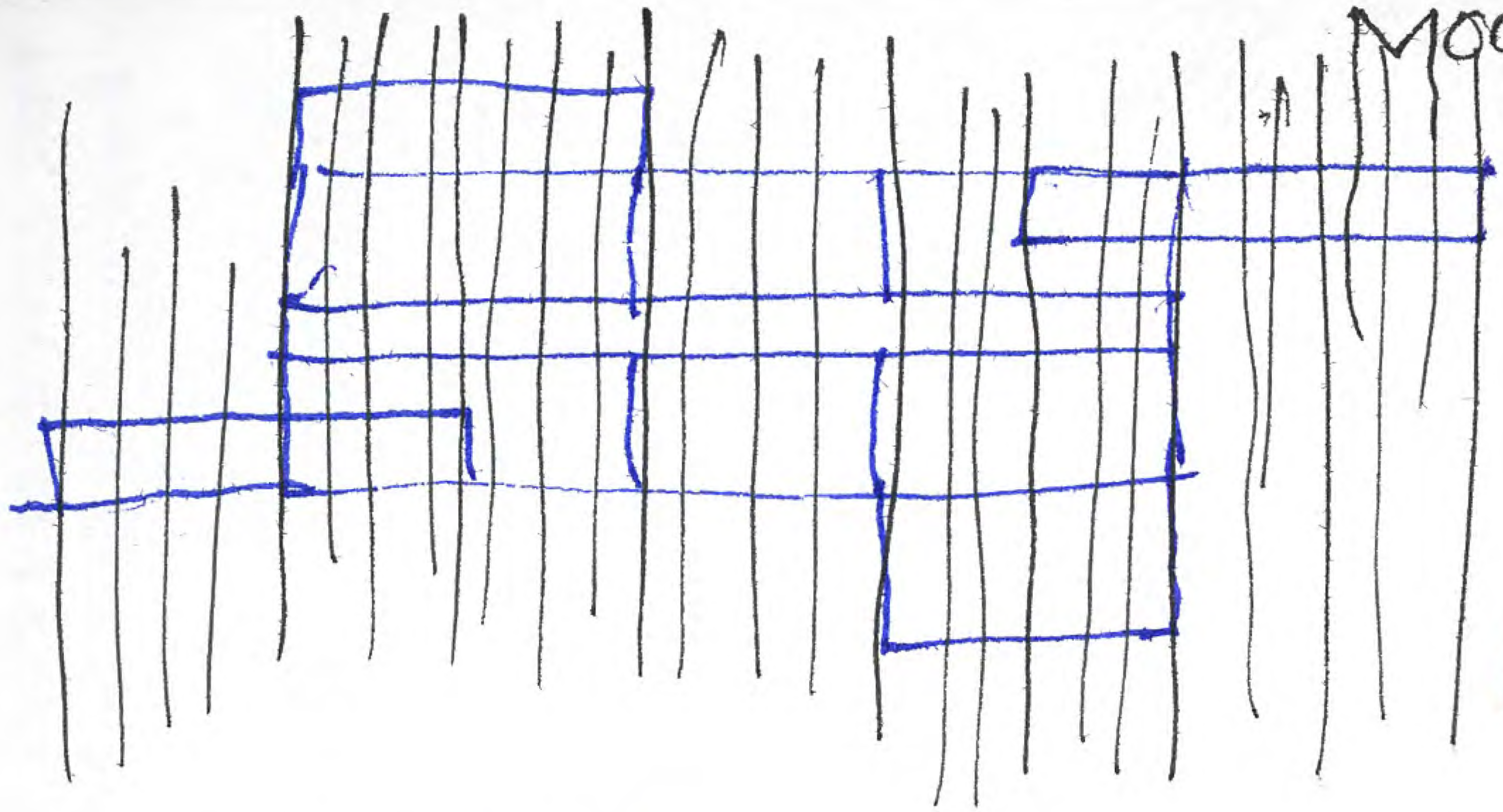

101

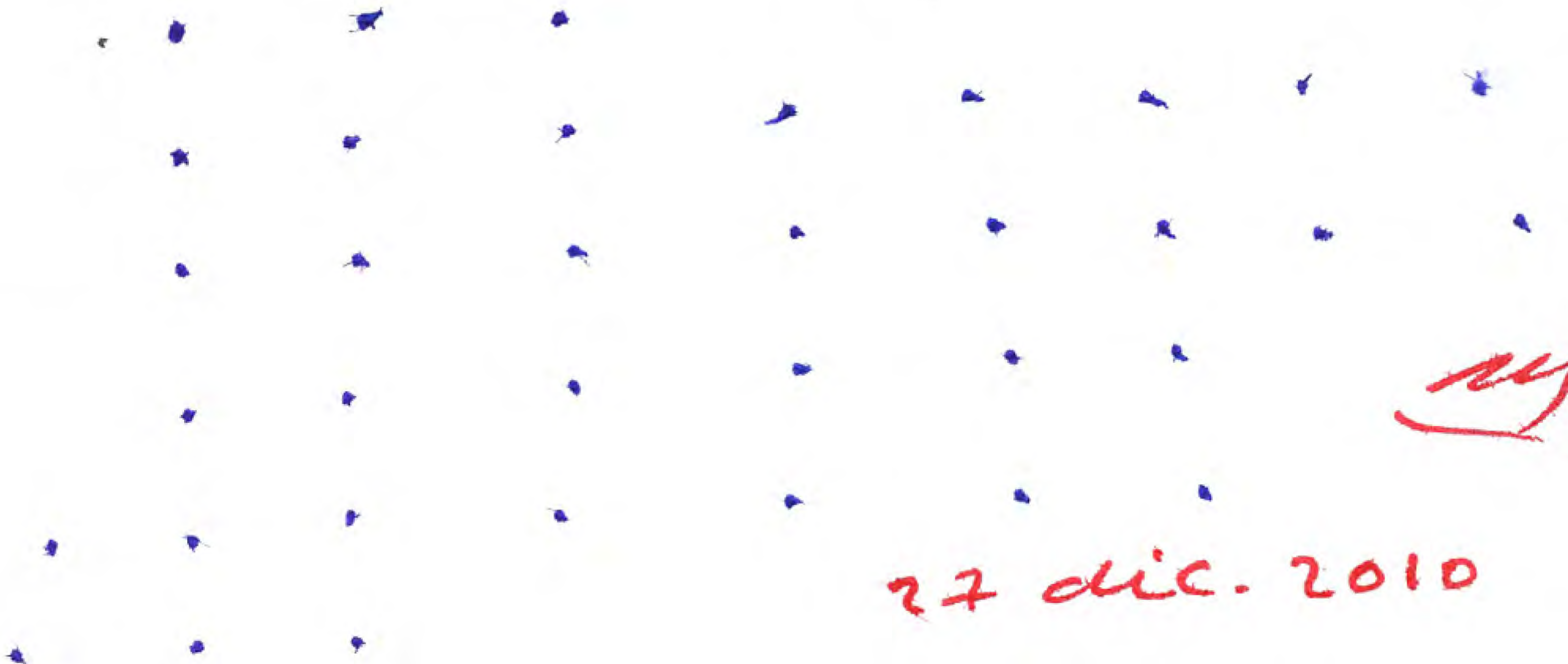

ny

27 dic. 2010



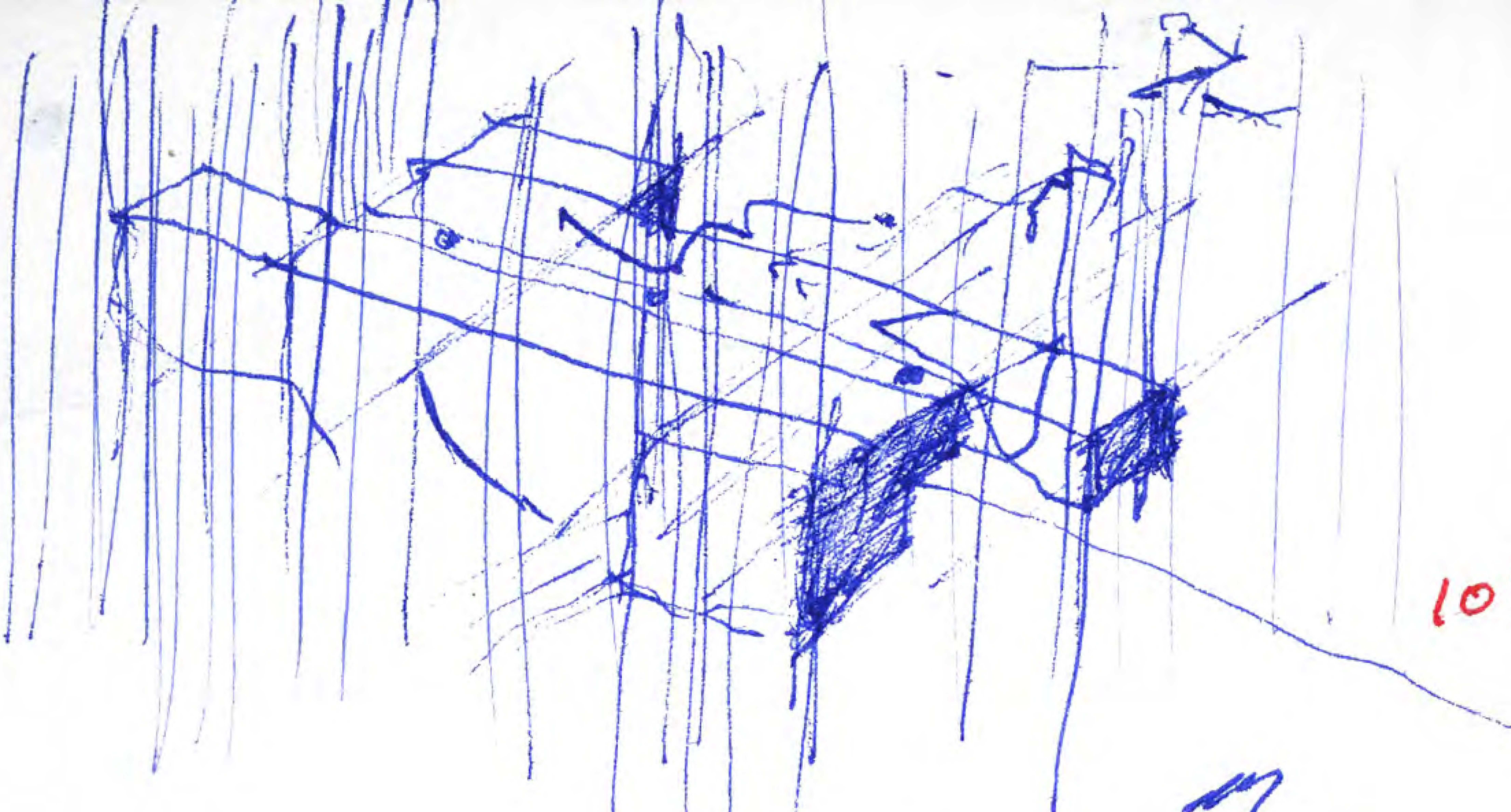

103

17  
Dec. 28. 2010 -

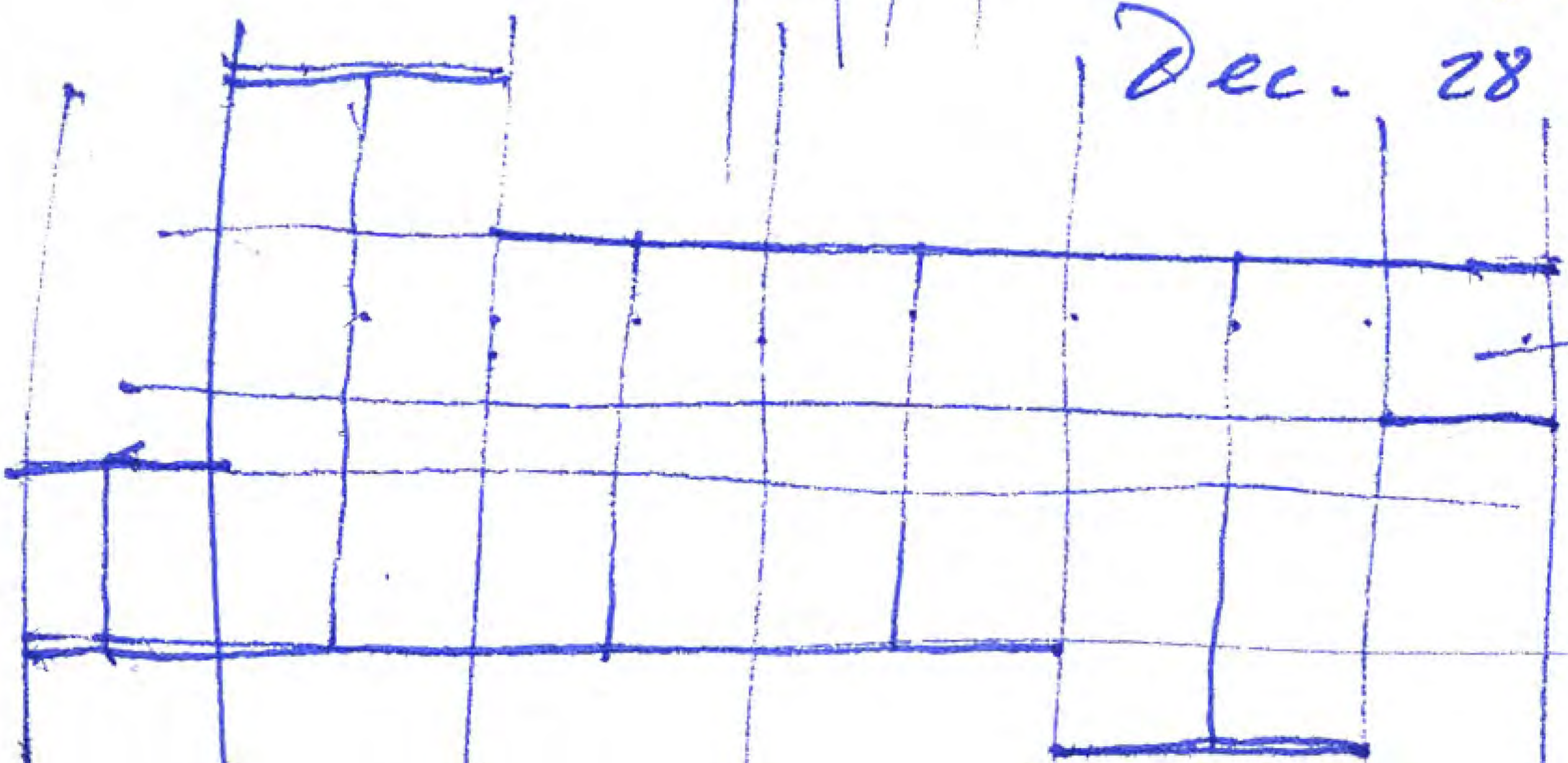

100 m<sup>2</sup>.

2700 m<sup>2</sup>.

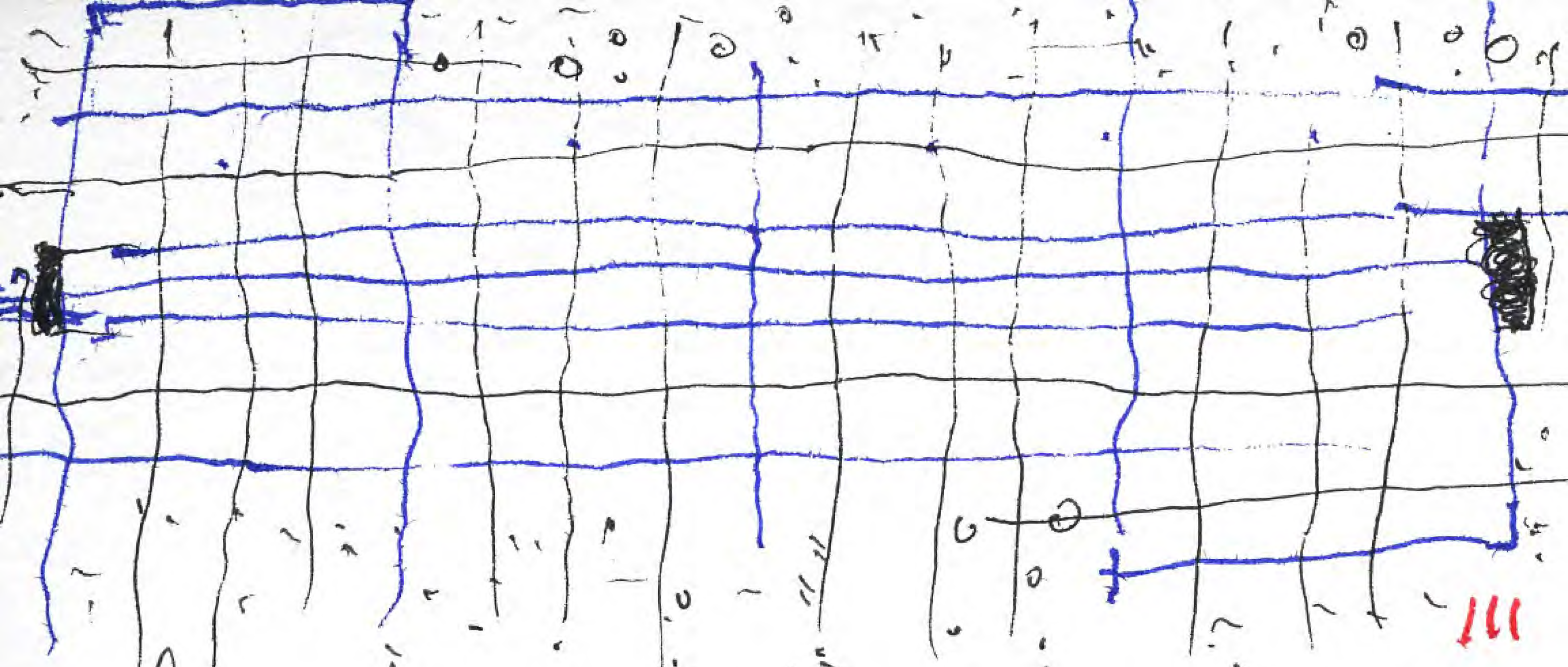

111

woods

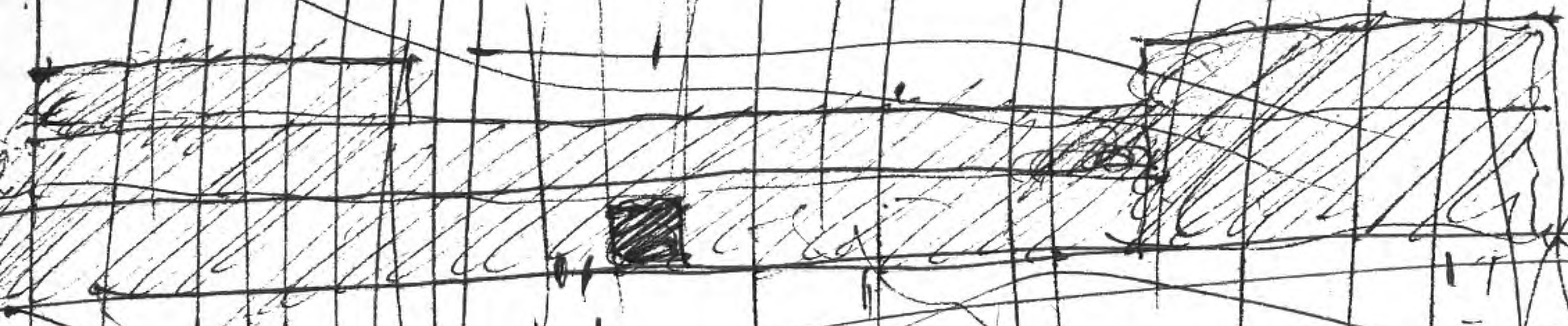

January 1, 2011

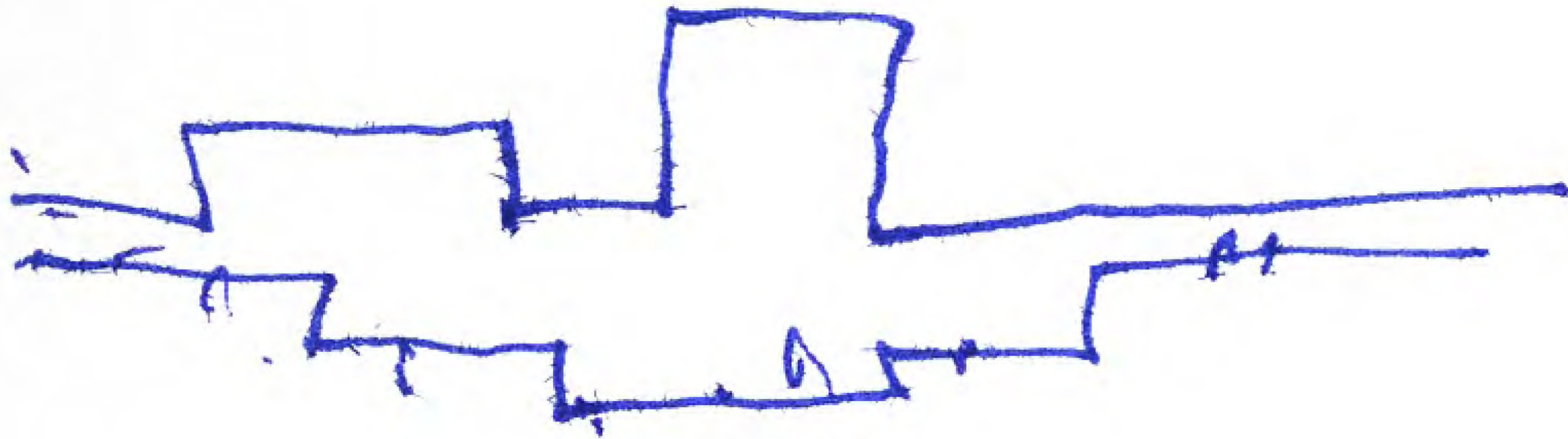

113

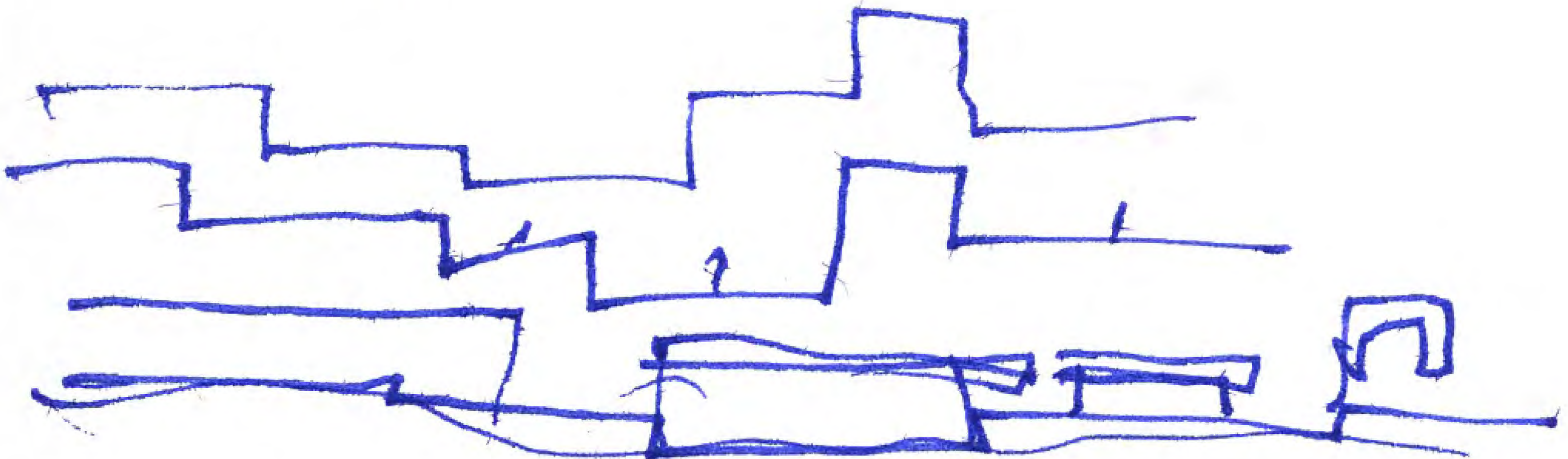
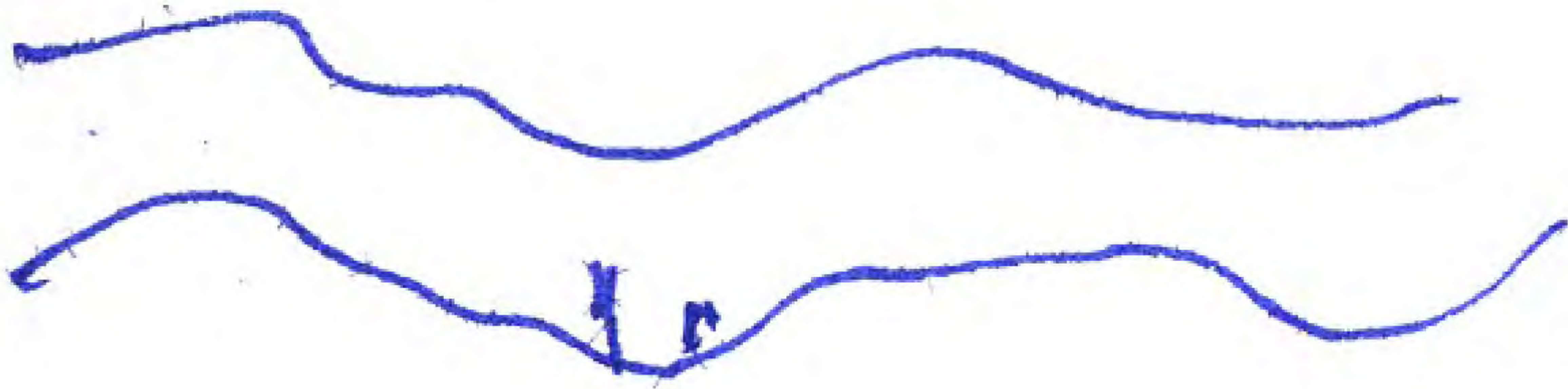

• PEZO

January 4, 2011

CHILE

COBQUECURA

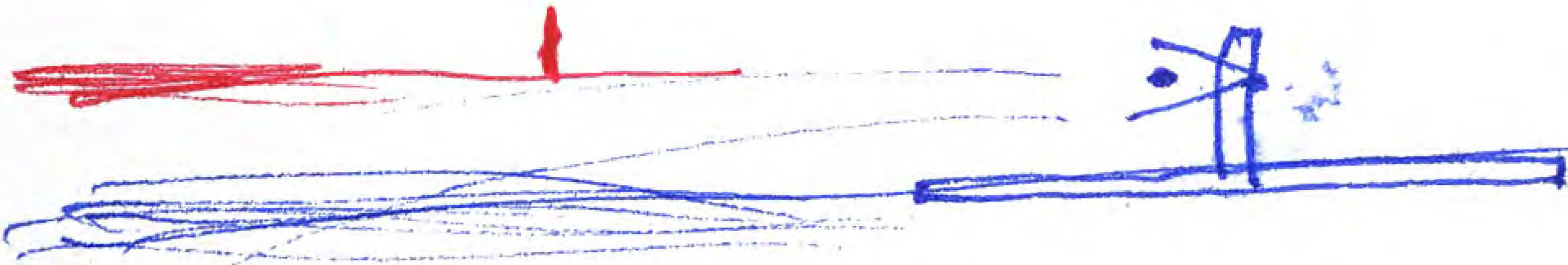

115



- referencia
- ojo
- faro
- mirador.
- antena
- pantalla

- plataforma (de agua)
- 200 m<sup>2</sup>
- función.
- suelo sólido
- cielo. aire



CHUTE

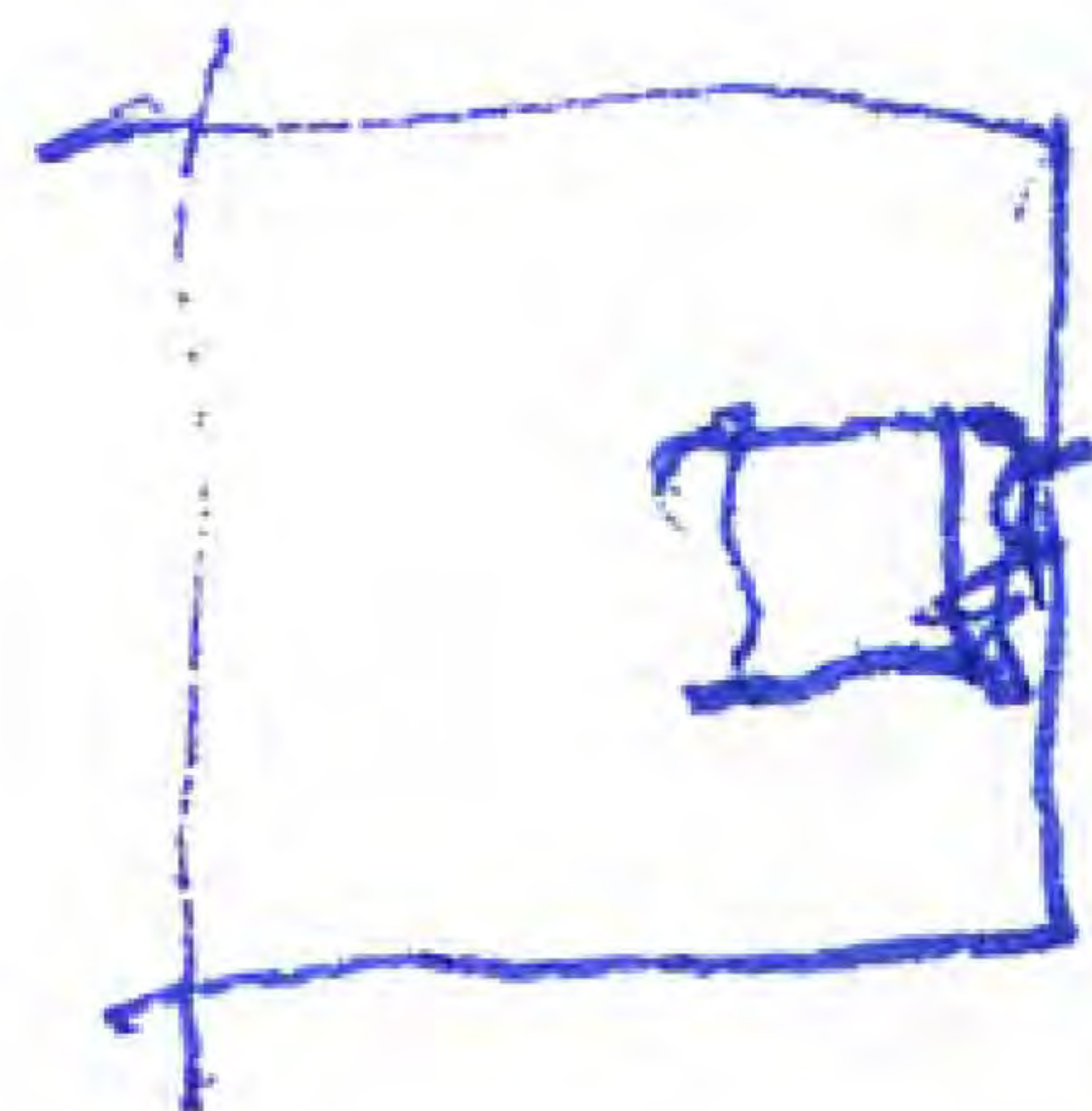
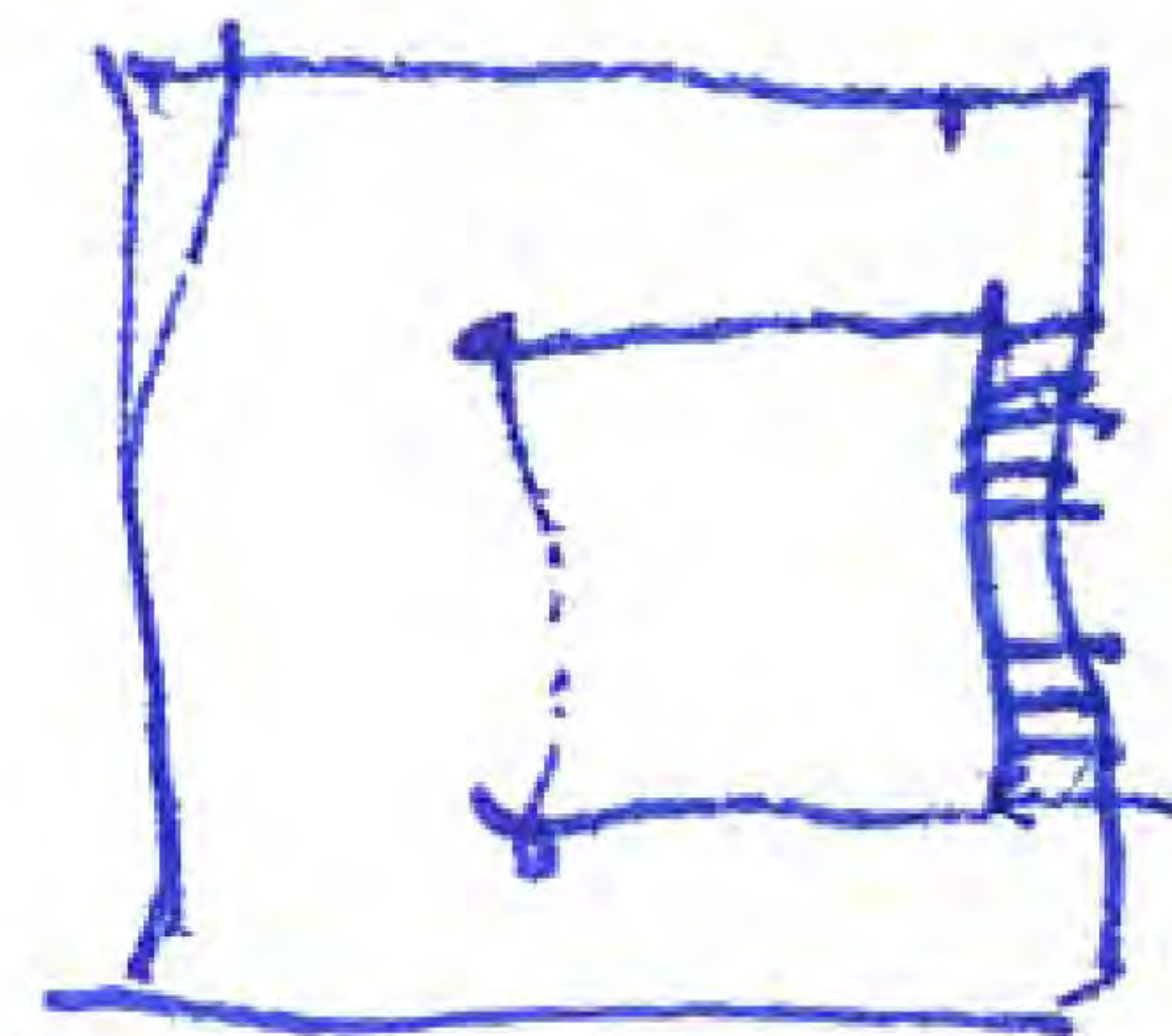
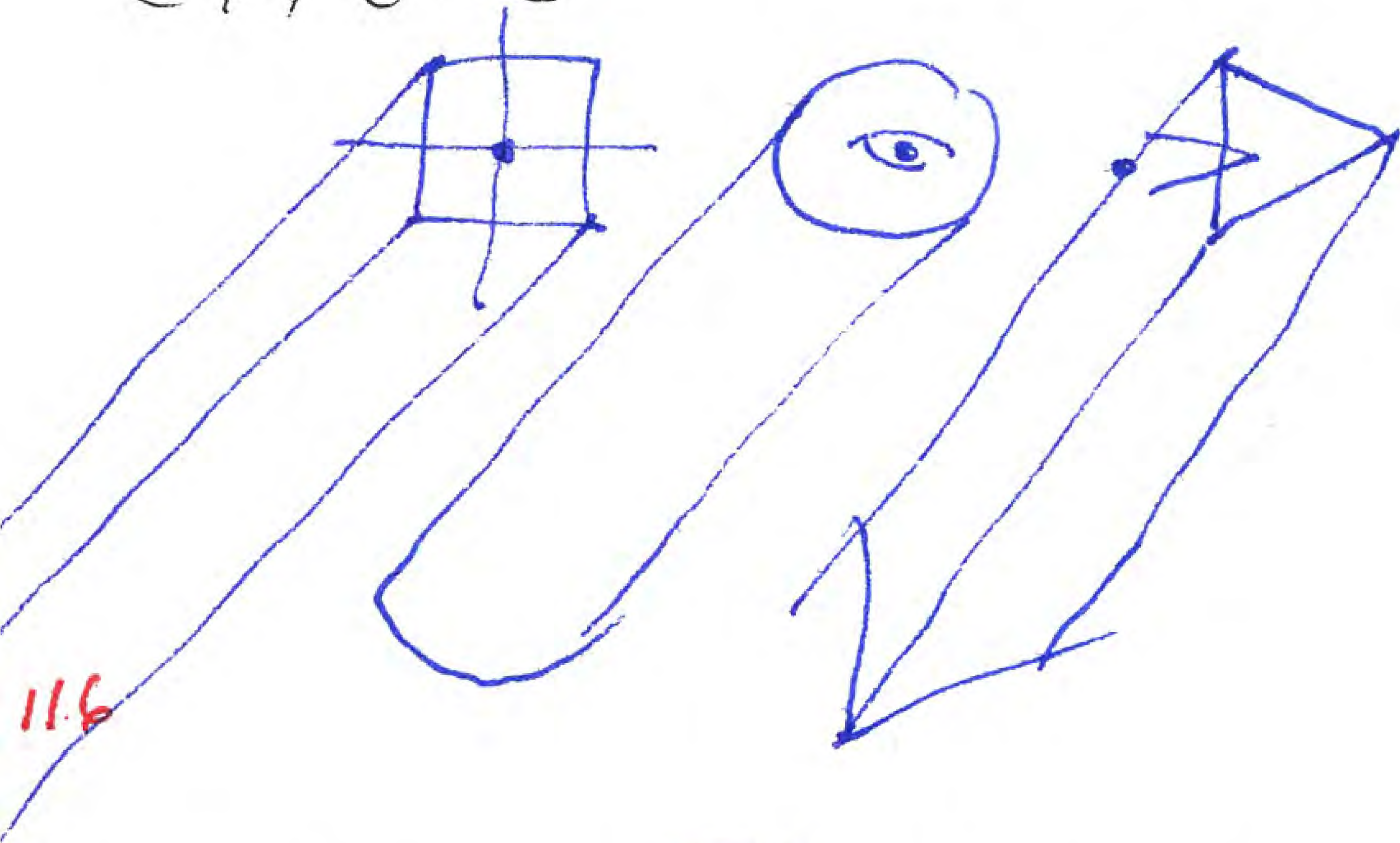

11.6

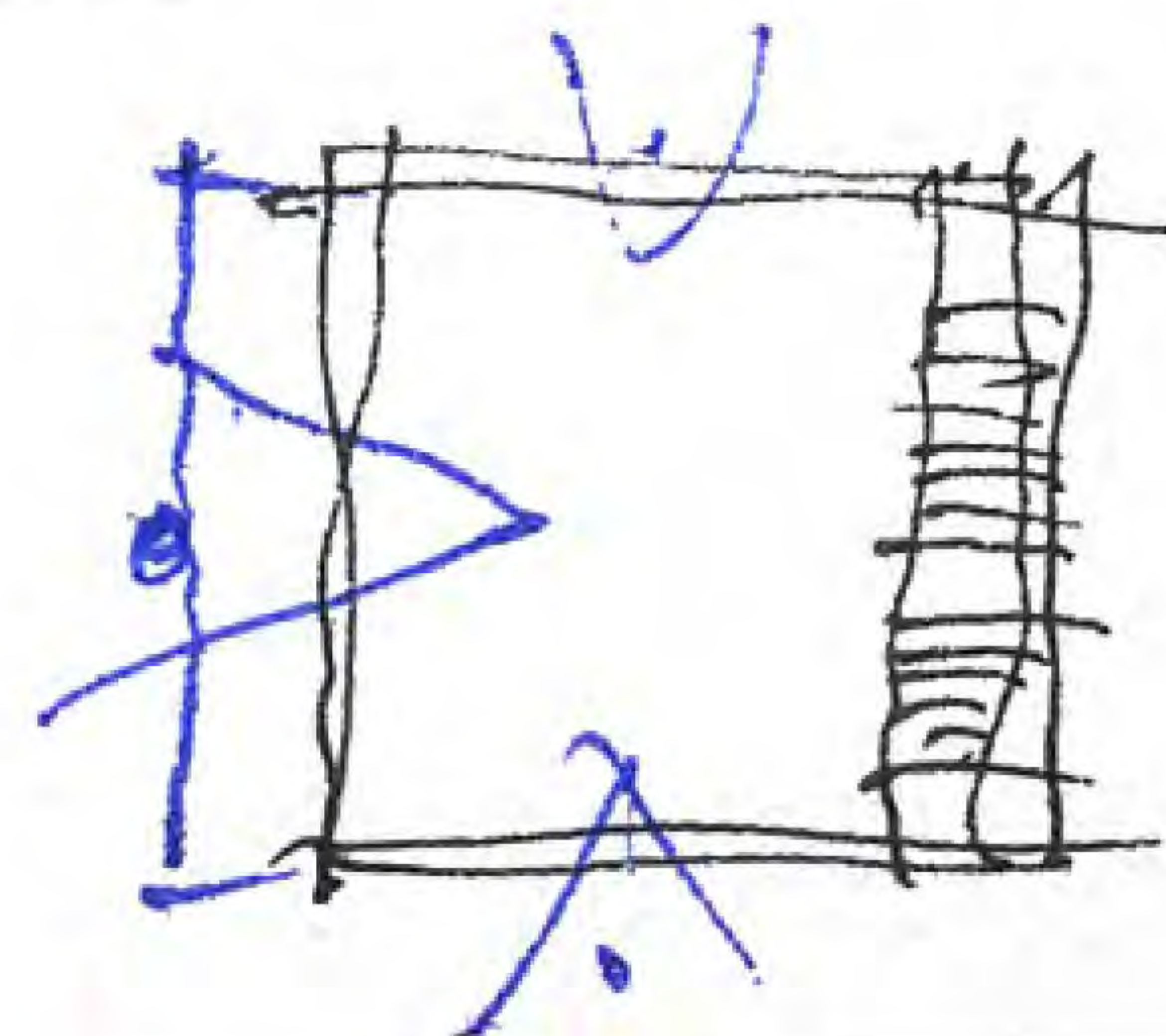
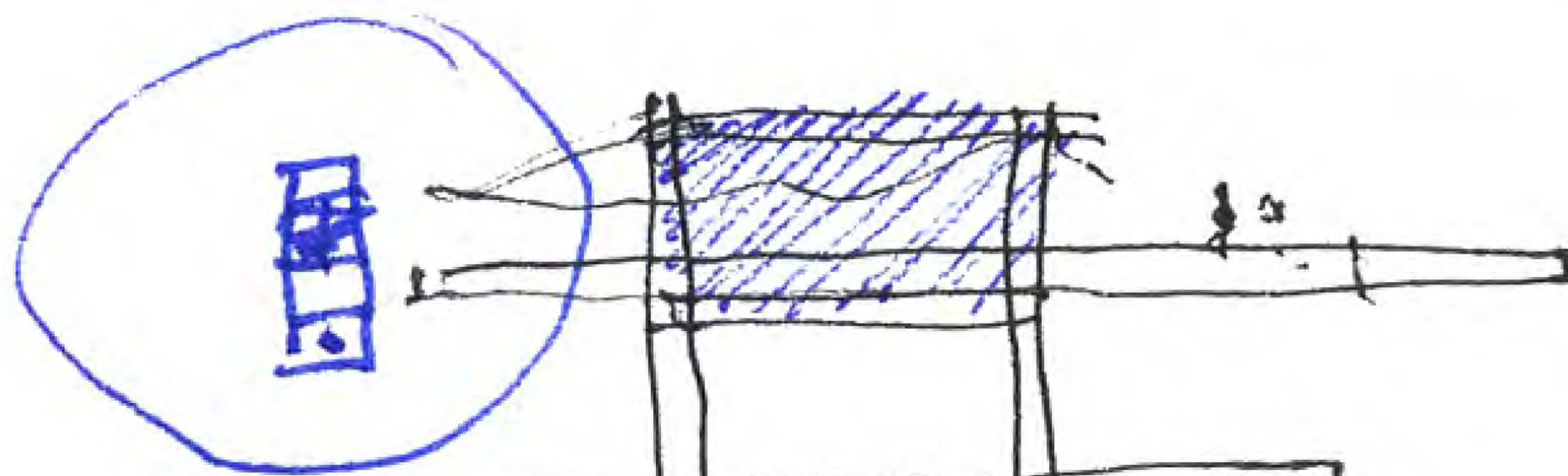
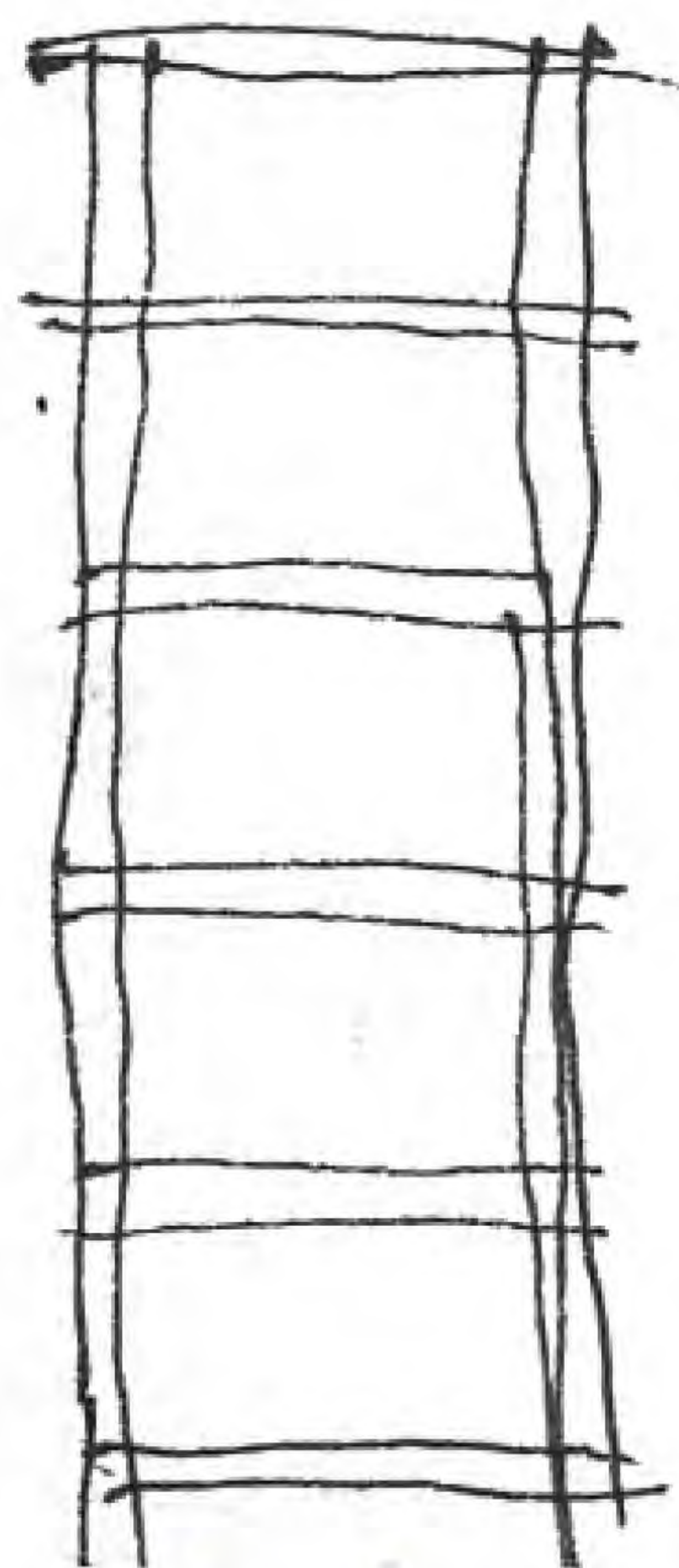

6 enero 2011

a las 13:10 en Recoletos

→ Musfardulhonola!

Comiars en casa del Tere!

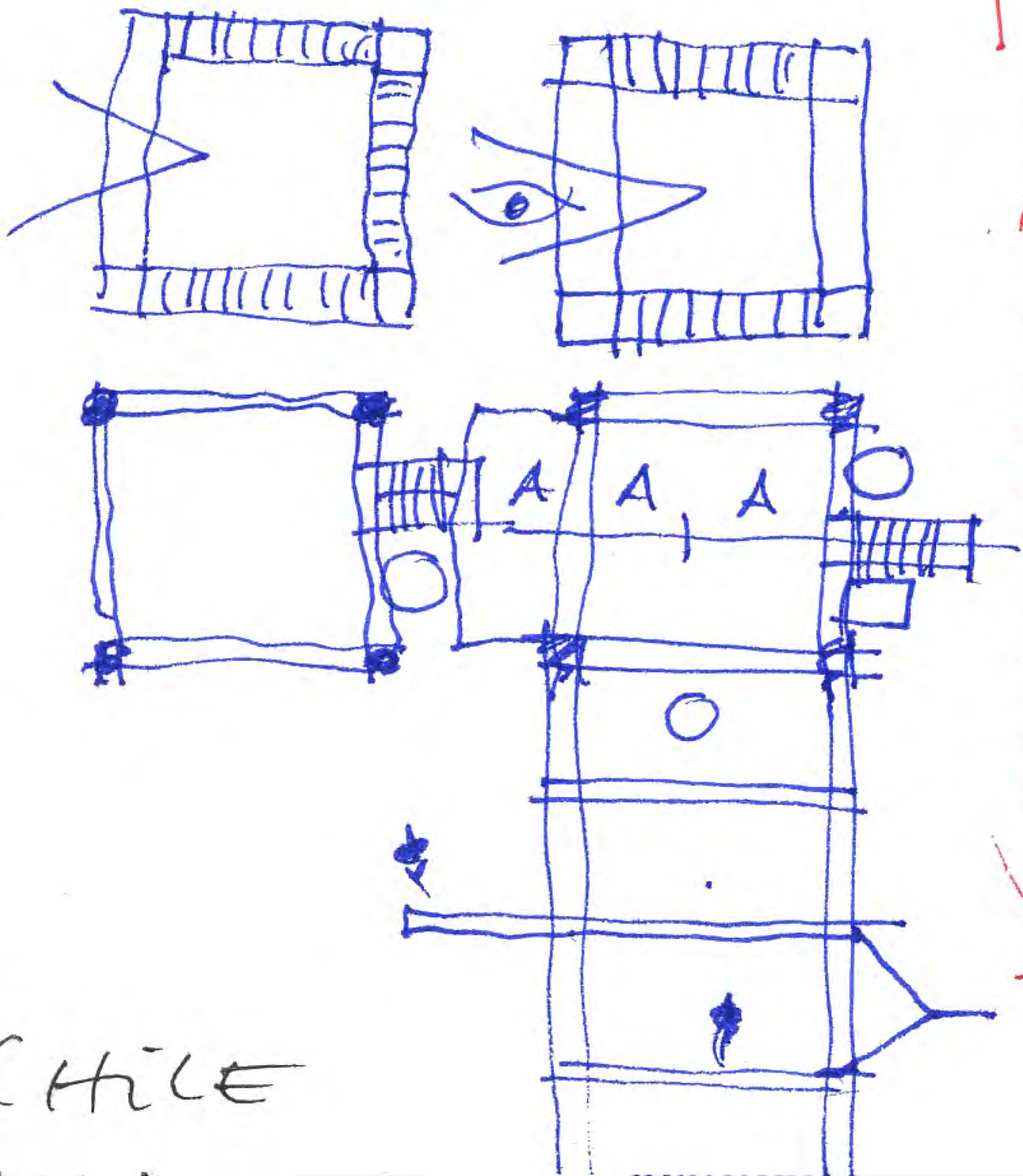

118

Chile

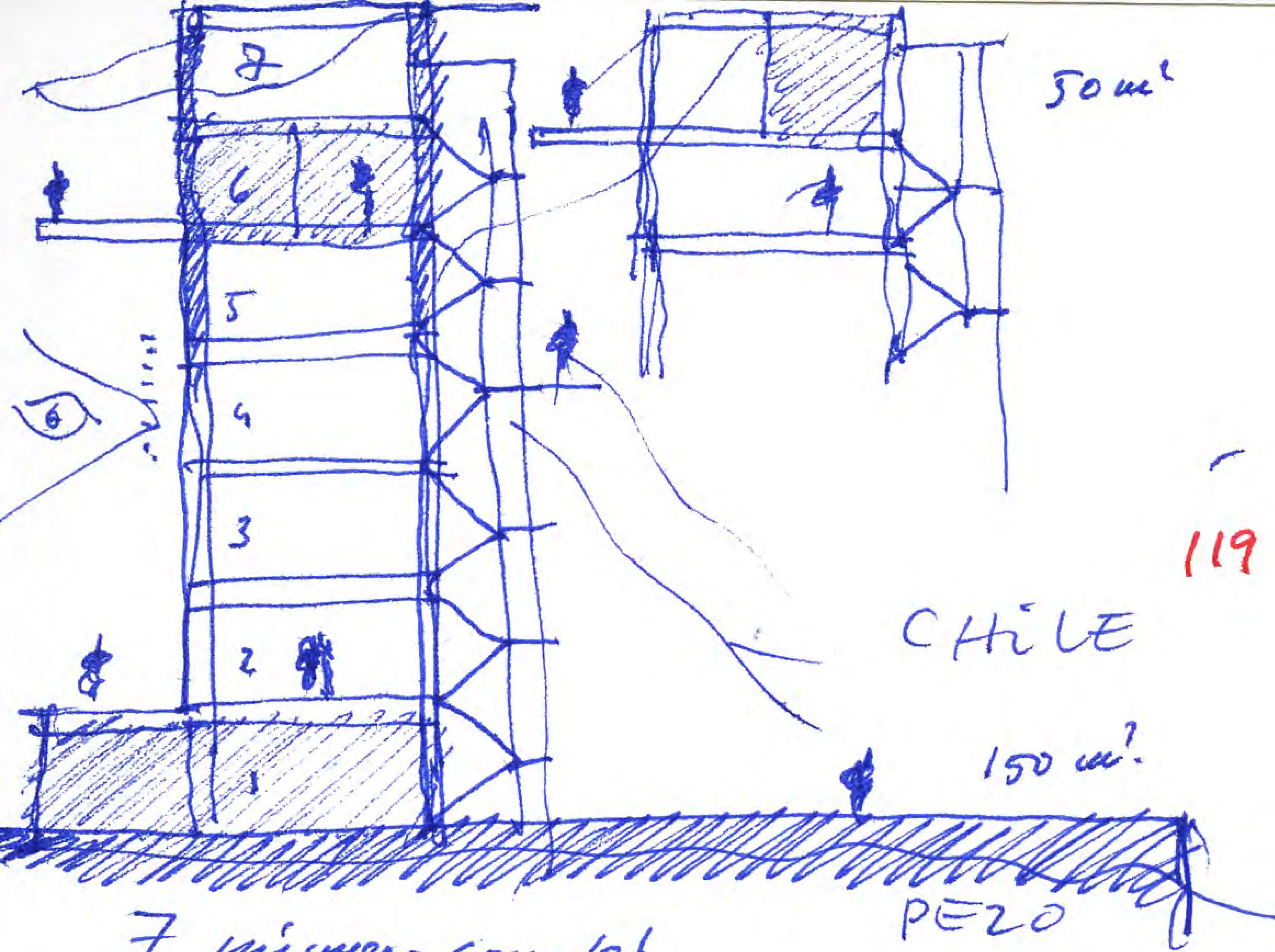

7 número completo.

abajo 150 m<sup>2</sup>

arriba 50 m<sup>2</sup>.

CHIZE

10

10

10

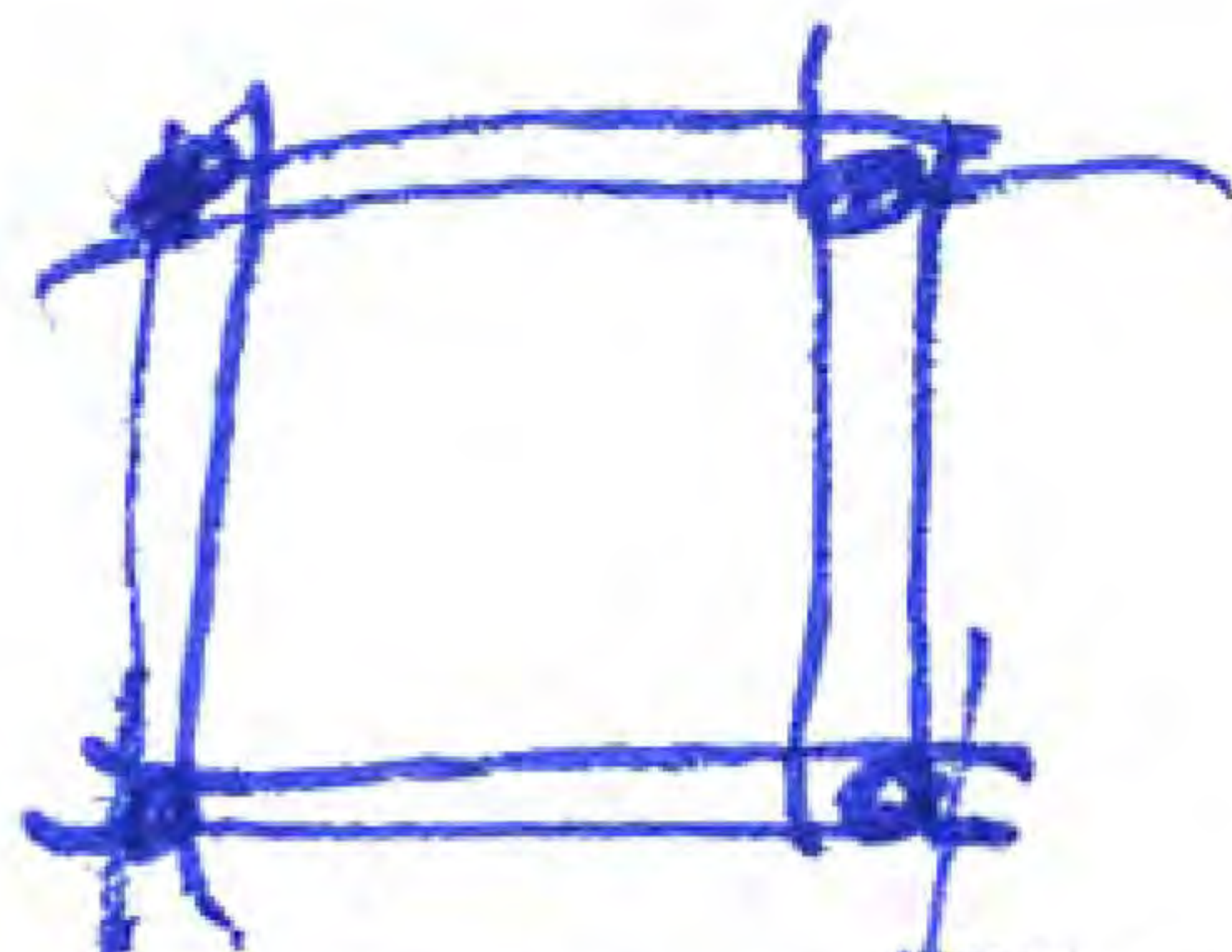

120

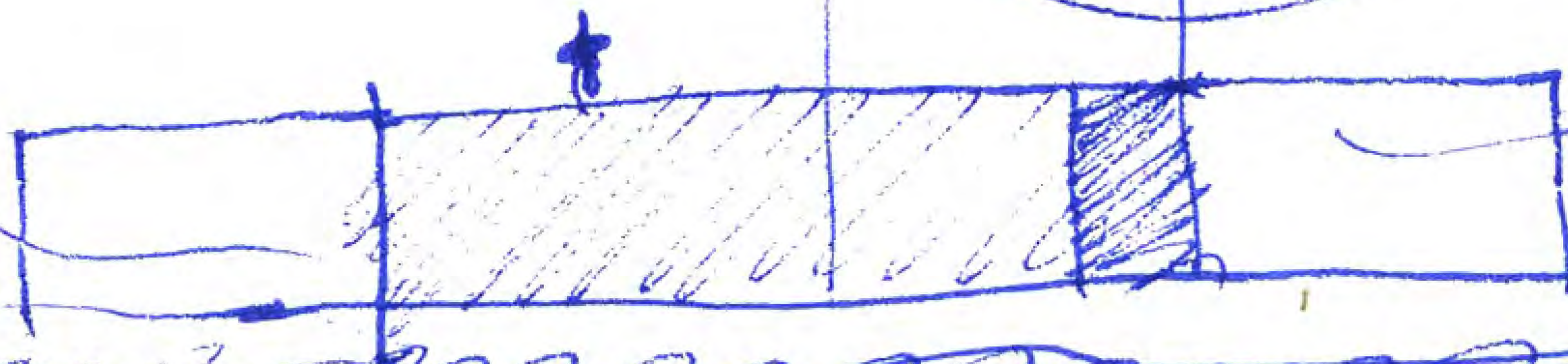

January 8, 2011  
Djere my.



• *unavoid*. 7 January 2011 ~ Coy  
 19<sup>30</sup> after much PFL (gracias!)  
 S. ad. muy feliz. A cuércolez 12 uer  
 onelcoo a NY. NY. Feliz.

'inmediata'

CHILE

OMIT. NEEDLES. WORDS

Stuck + white.

SOBER. STABLE. CALM <sup>121</sup>

una estructura.

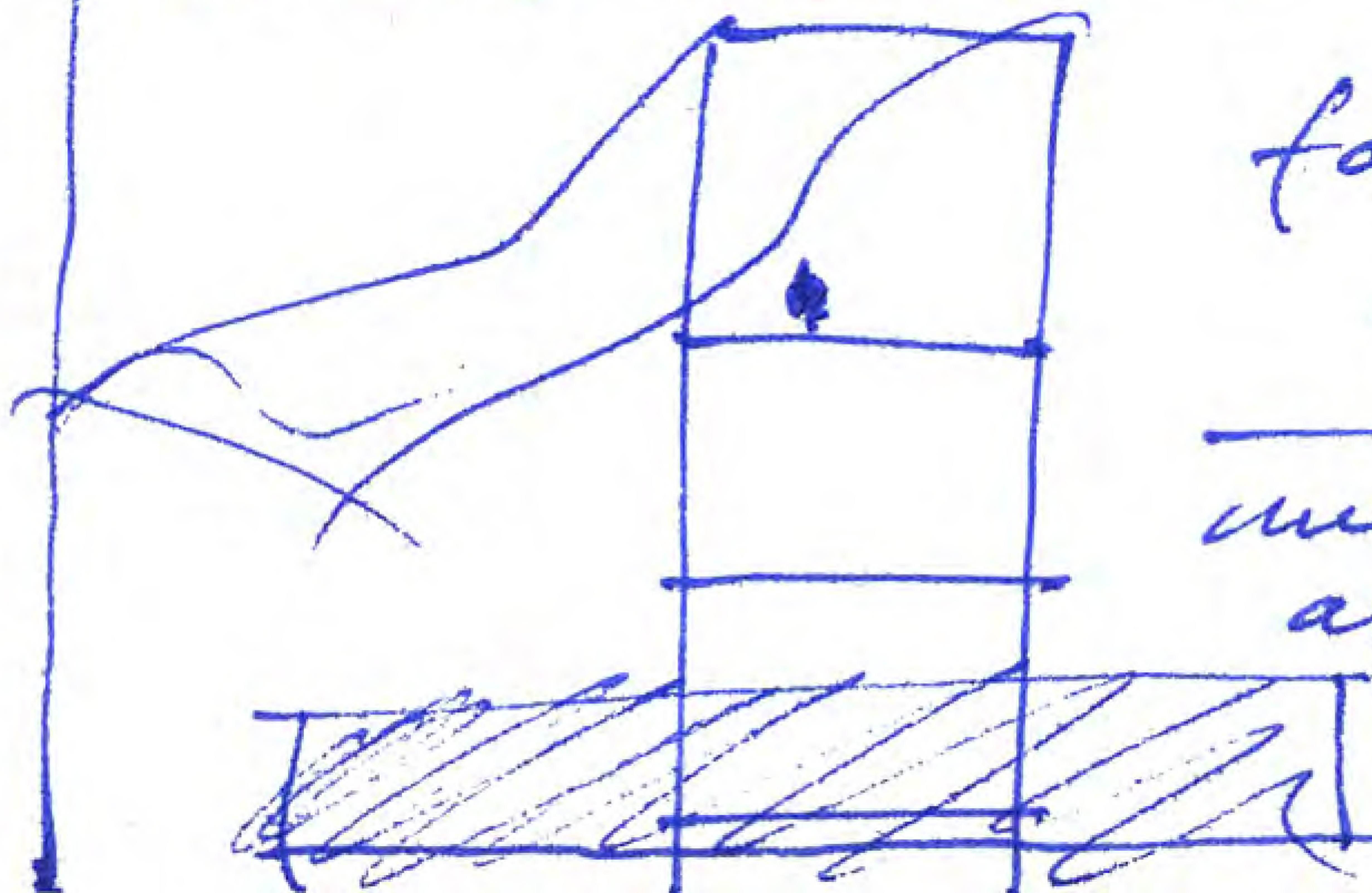

farola 5 50 h<sup>g</sup>  
 $5 \times 1'5 = 7'5$

maestro 12.  
 al nuevo 9  
 m. h.

M005.

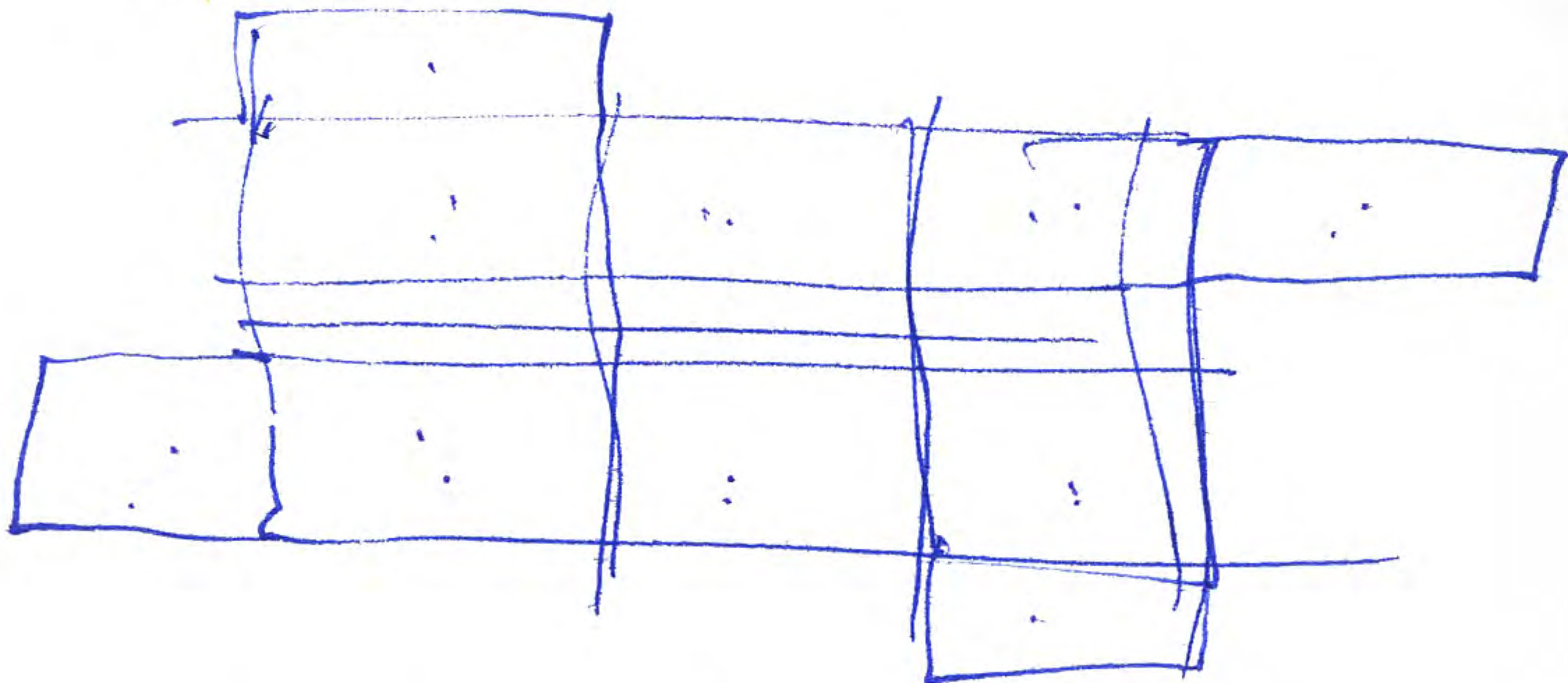

$$9 \times 12 = 108$$

$$9 \times 18 = 162$$

$$9 \times 27 = 243$$

10 + 1<sup>15</sup> unidades

consultar con unipuel  
P.

18

M005

9

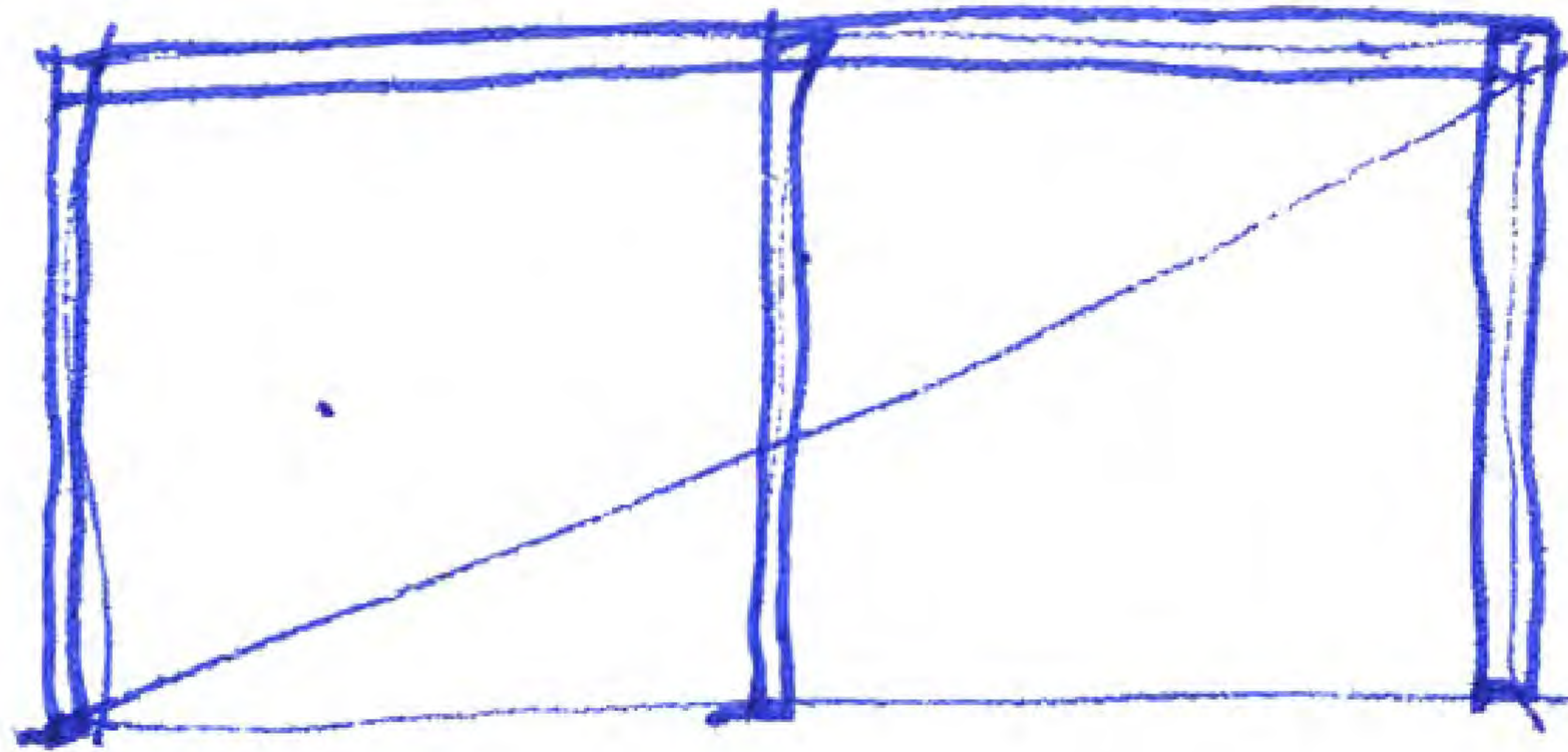

123

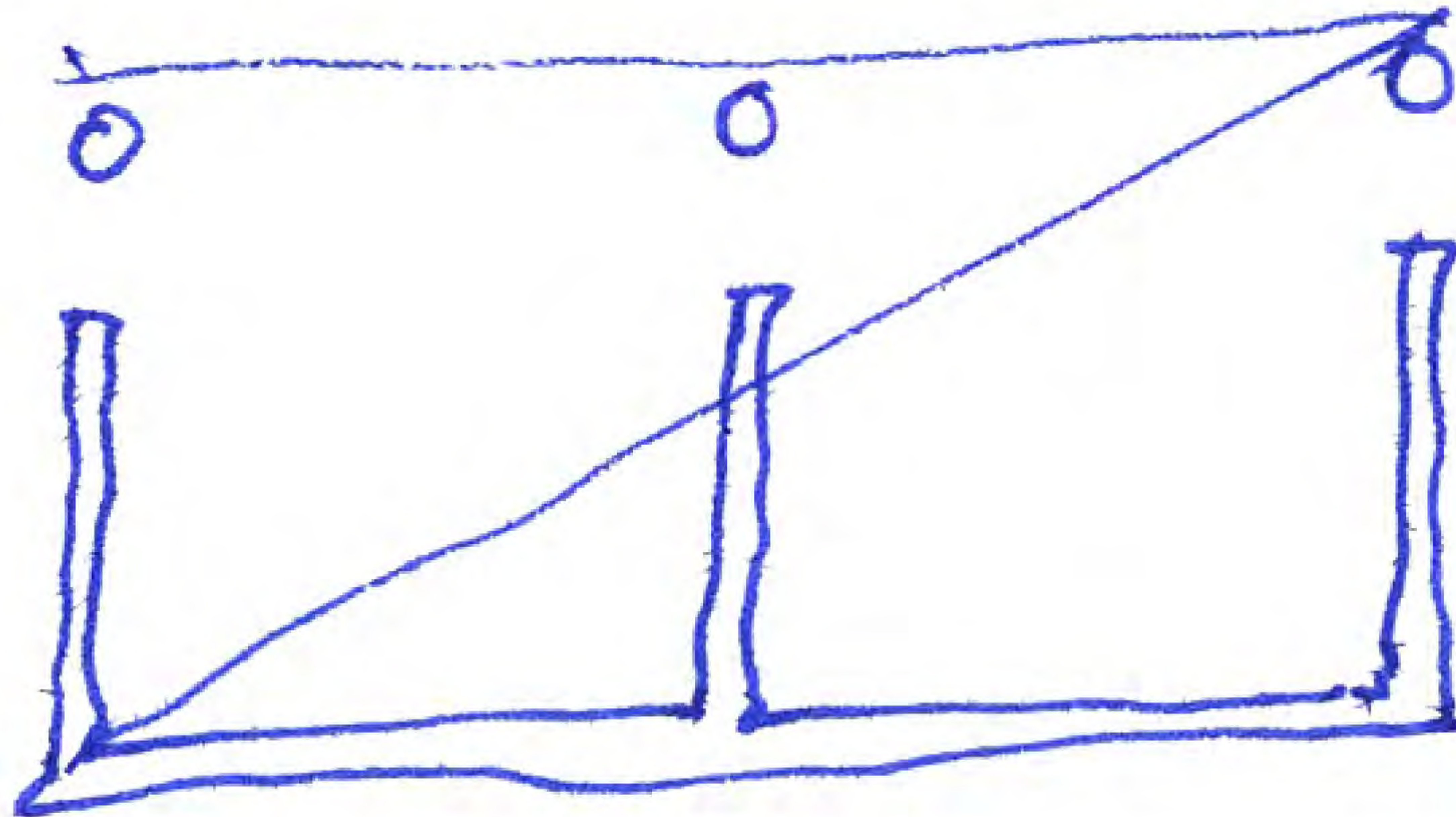

*my*

Jan 8  
2011

COBQUECURA  
 Jan. 11. 2011

$$A^2 + A \cdot B = 200$$

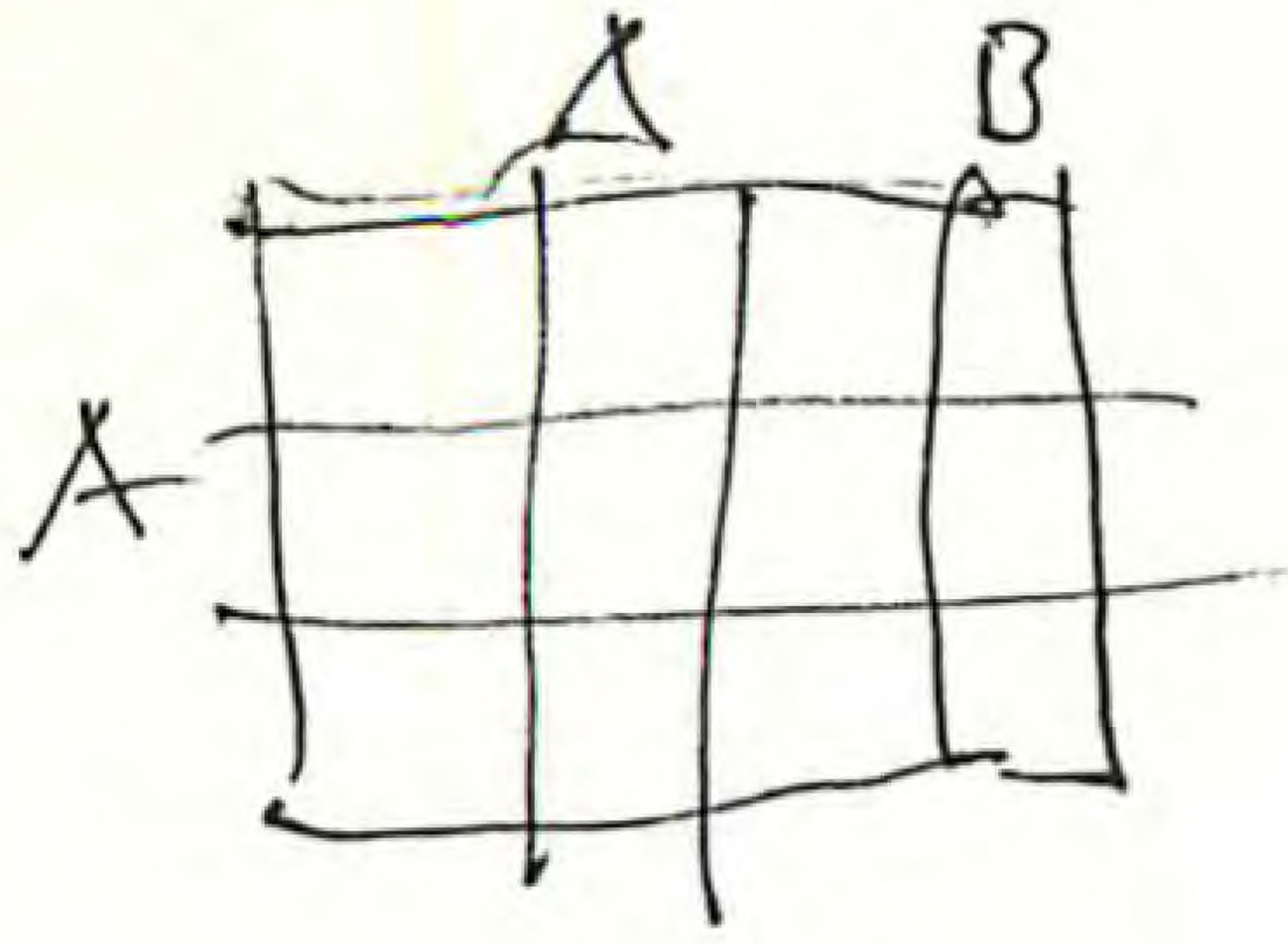

$$12 \times 12 = 144$$

$$12 \times 4 = 48$$

---

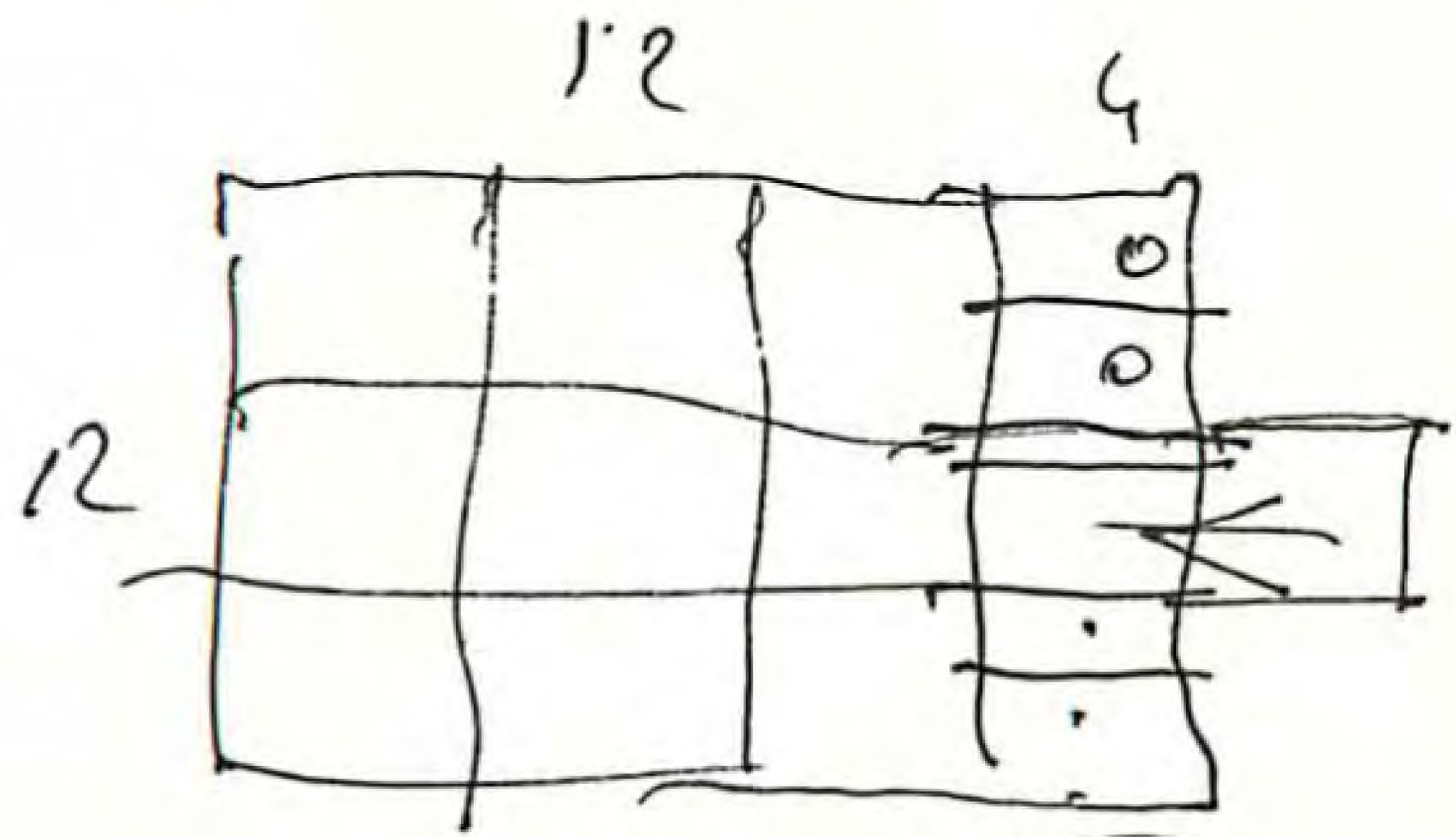

$$192$$



125

160

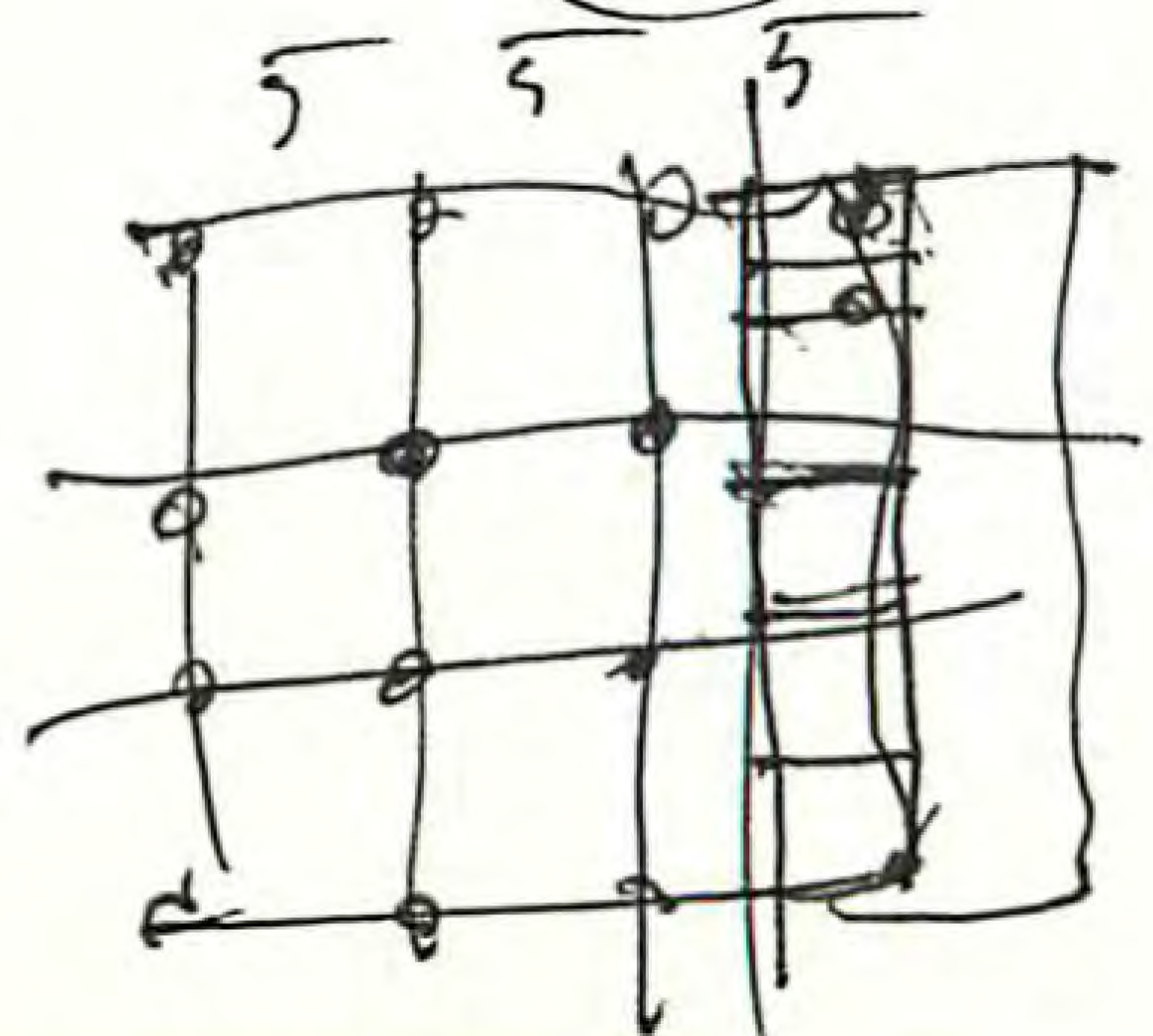
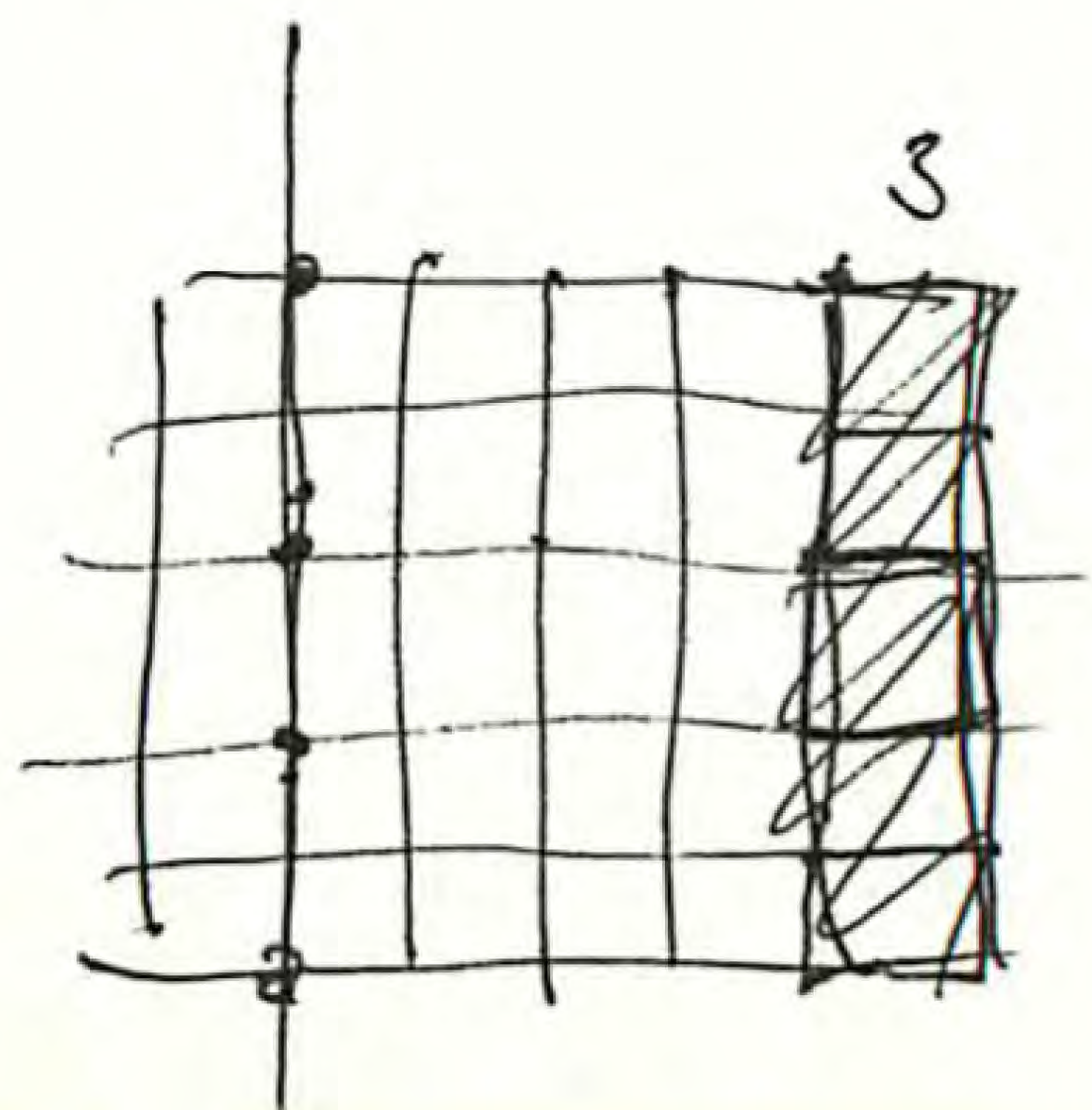
40



$$16$$

$$12$$

---



$$32$$

$$16$$

---

$$192$$

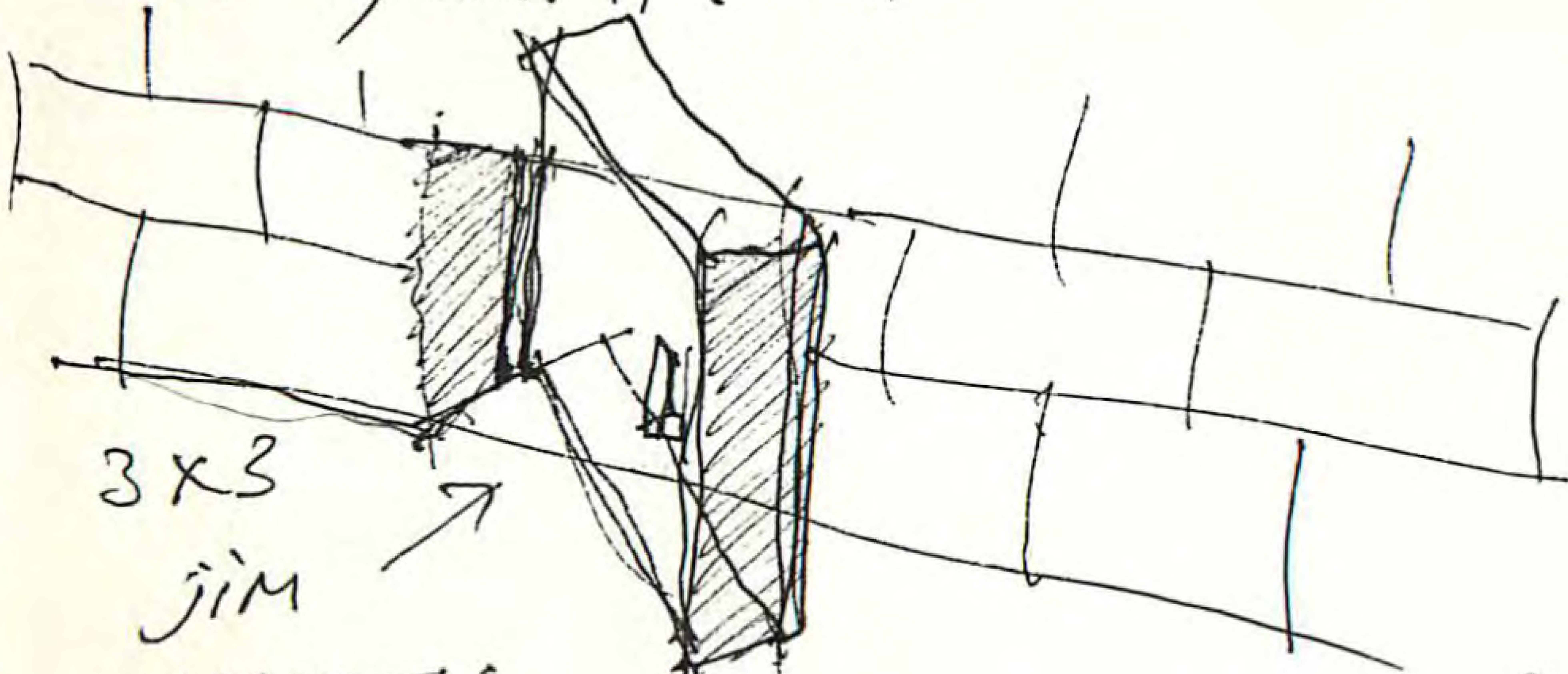
2A Jan. 11, 2011



3x3

jim

CAMPBELL

1x1

puente 3x3 x 0'50

CUBITO

240-260

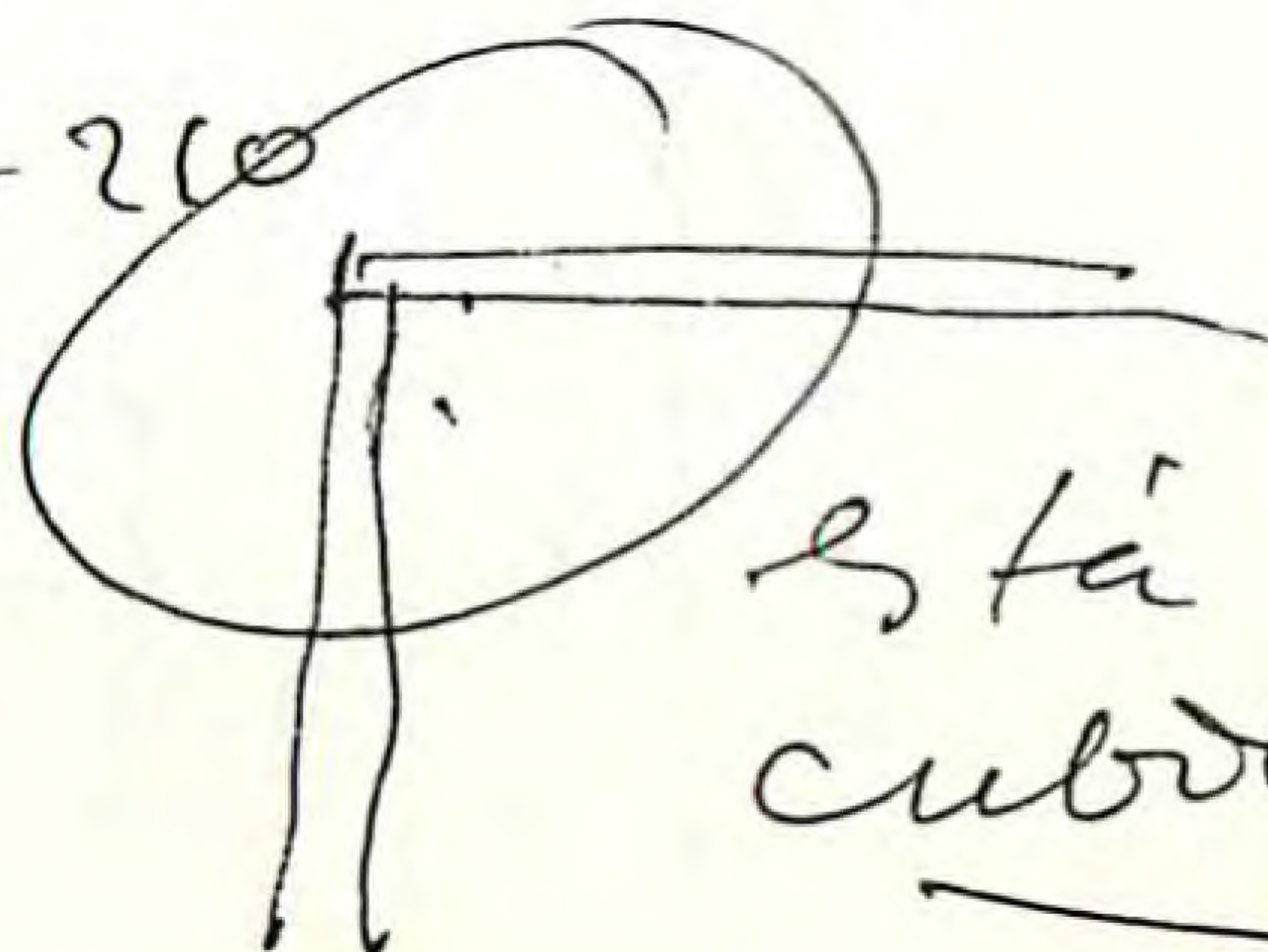
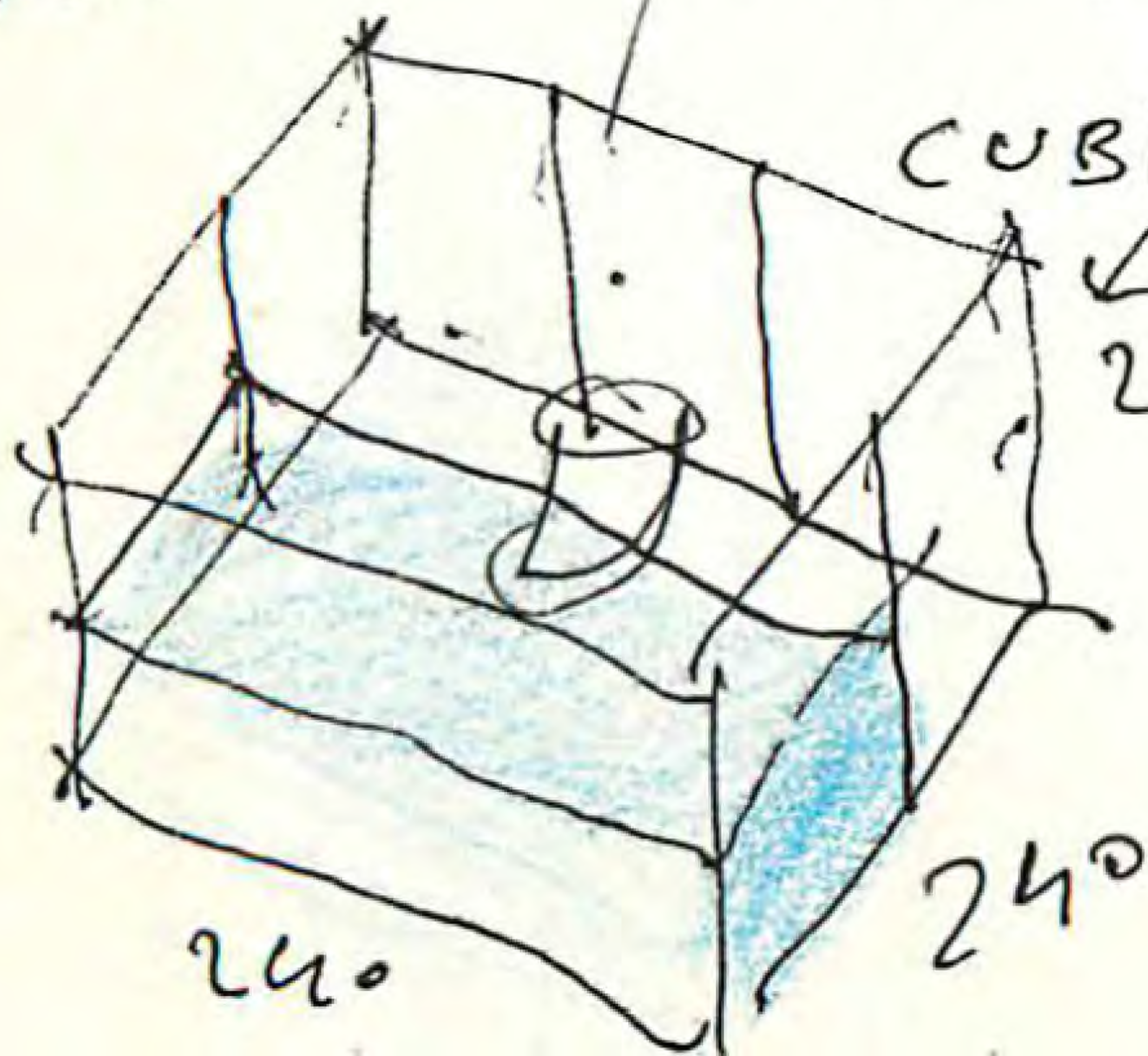

esta cubo de

árboles

castaño. ? ZA

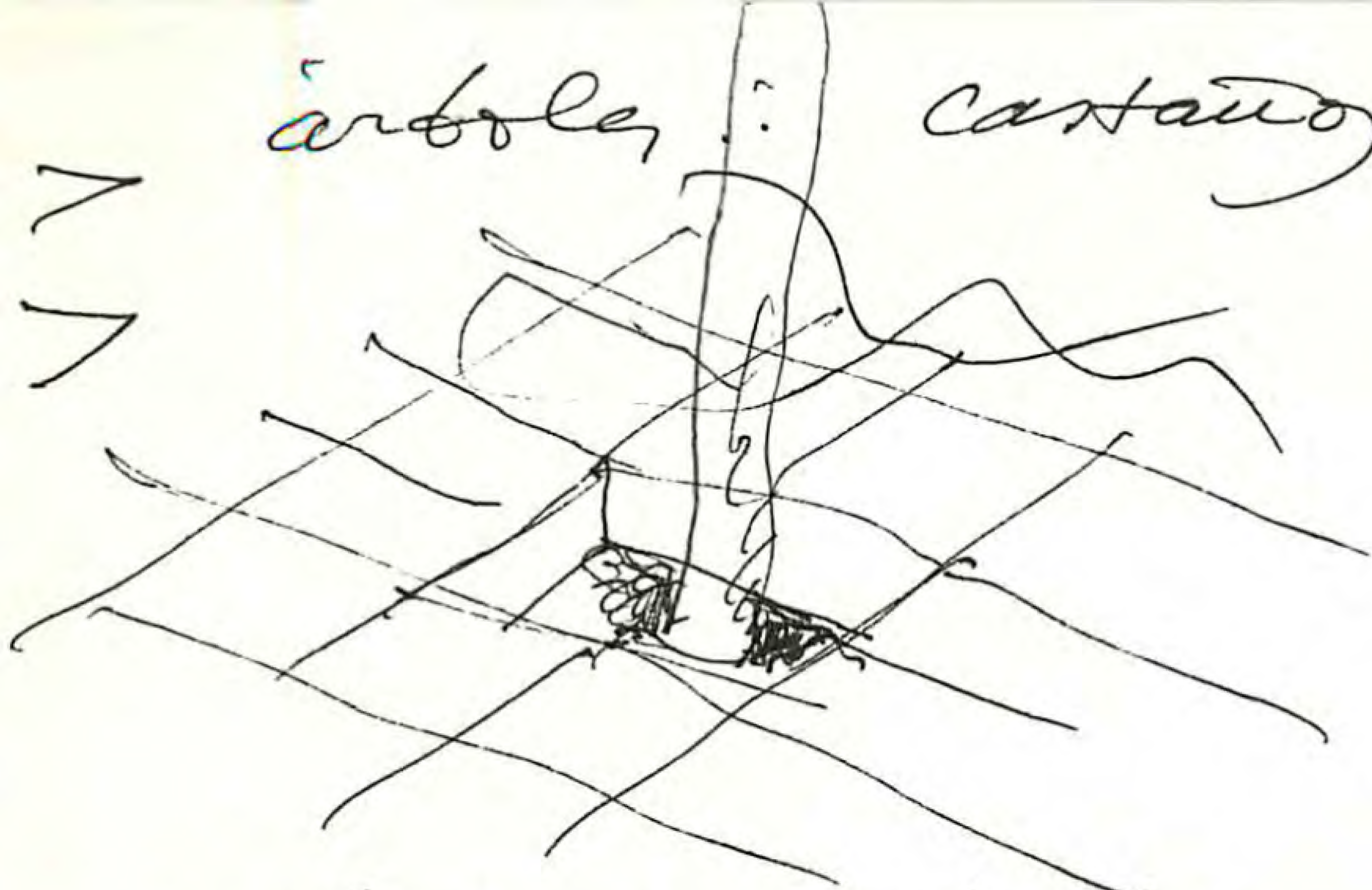

127

alcarque piedra.

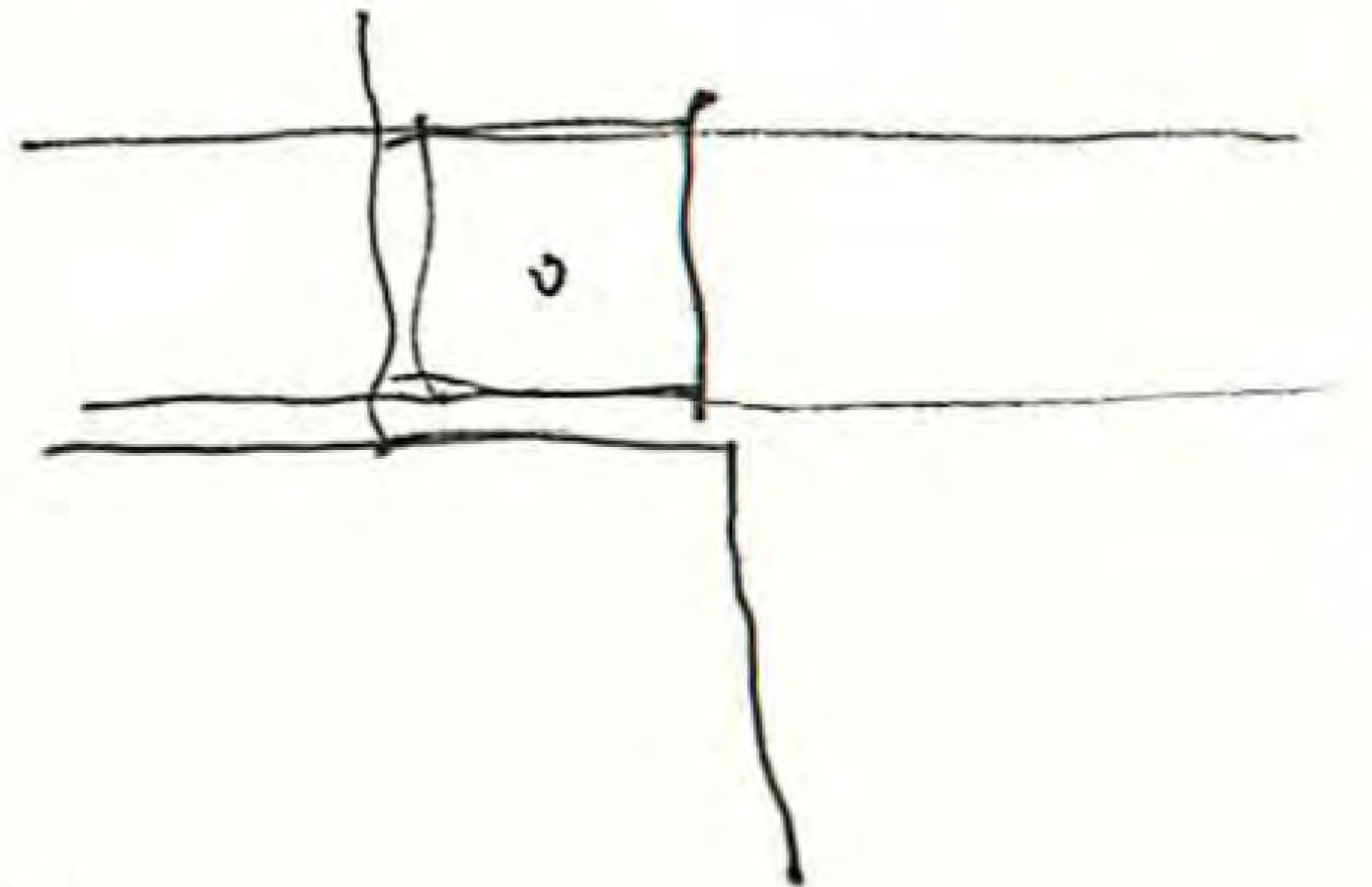
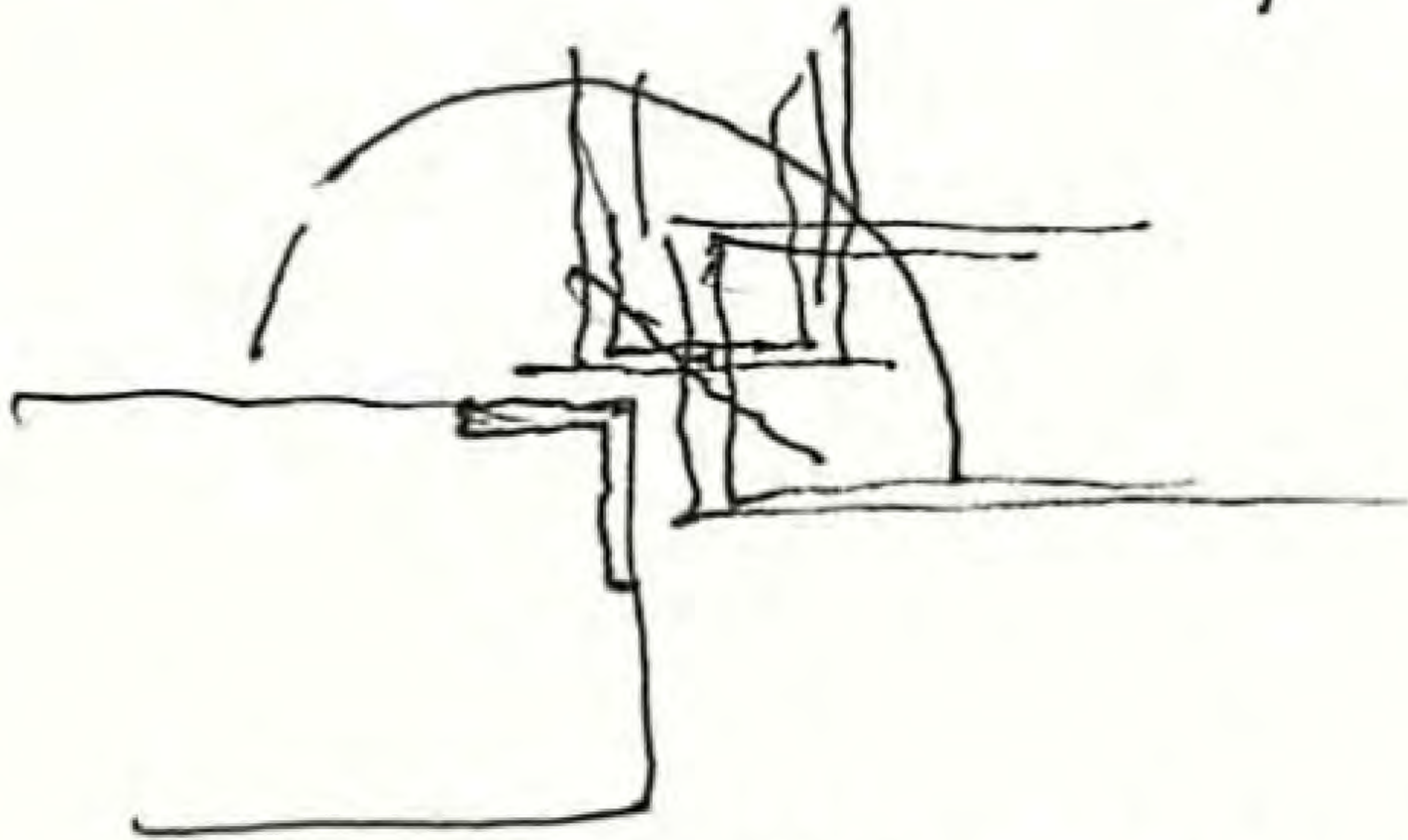

13 enero 2011

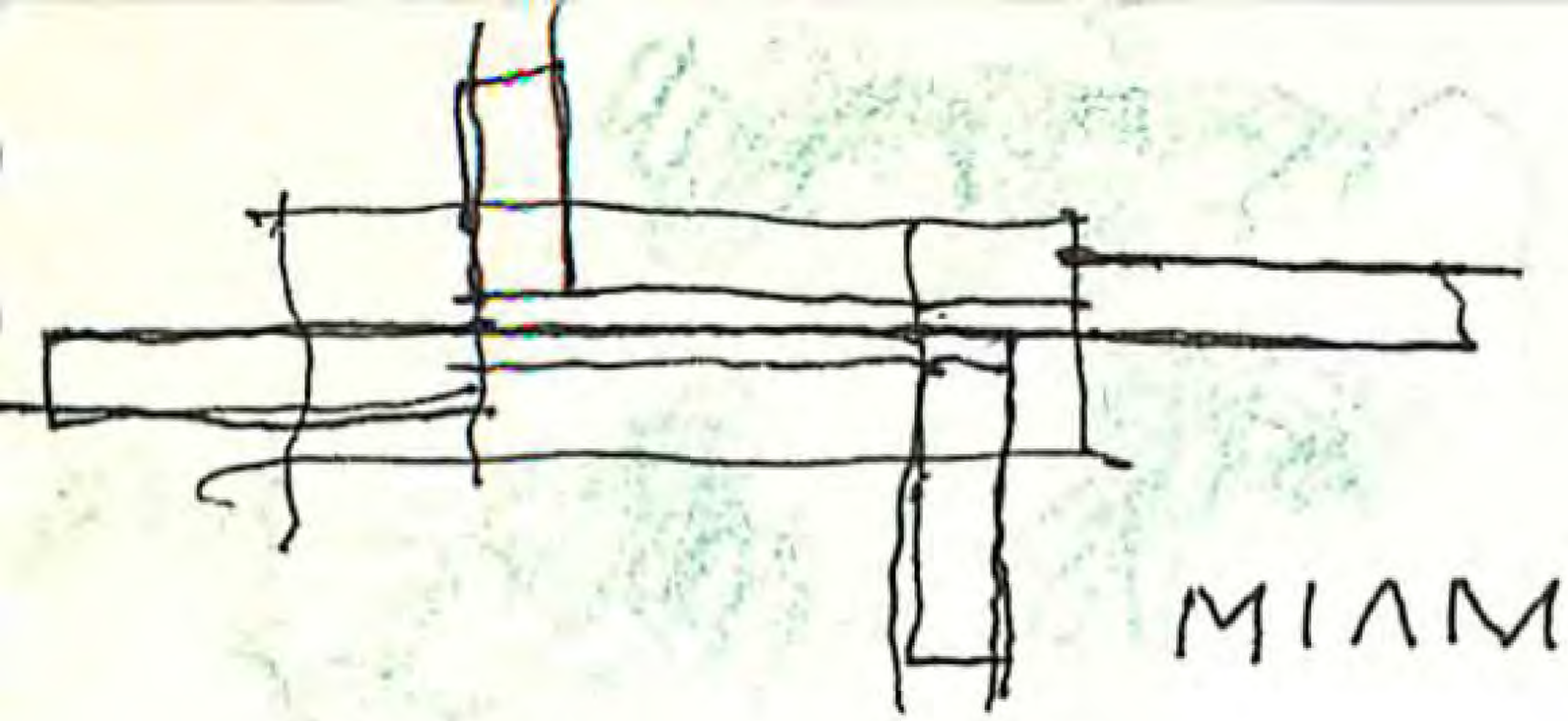

MIAM



CHILE

W

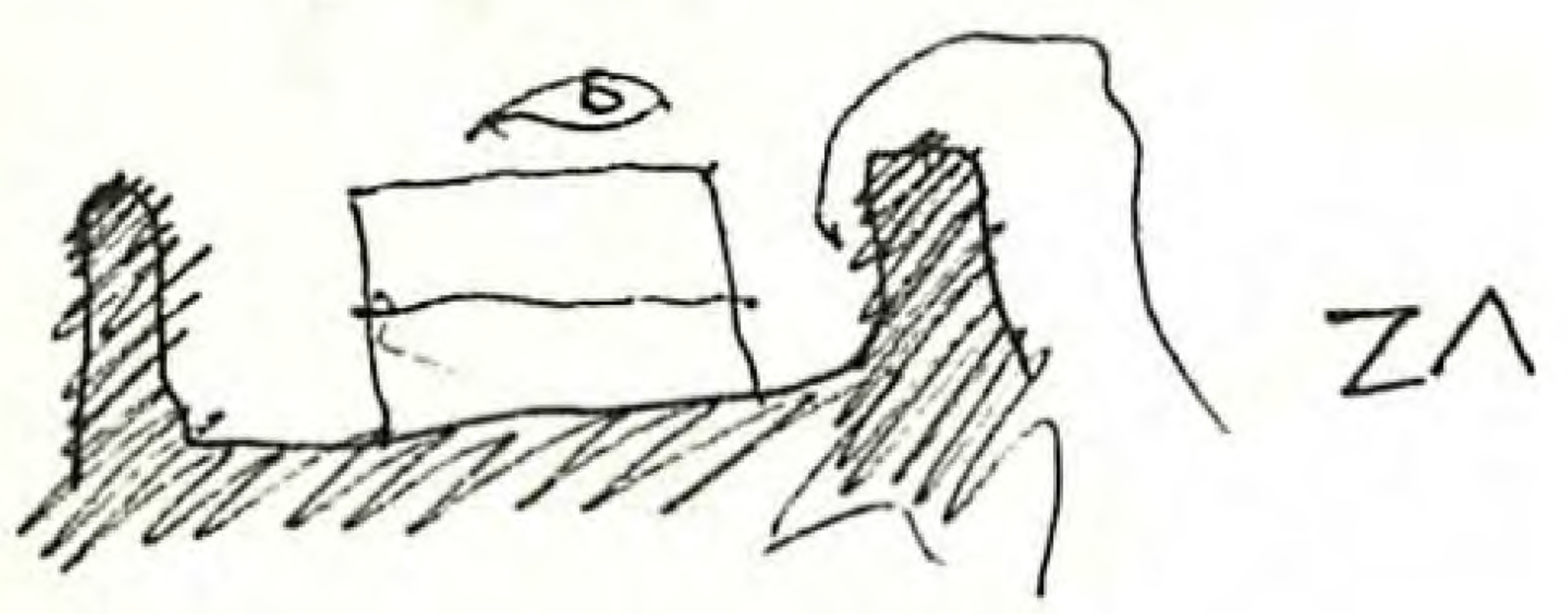

ZΛ

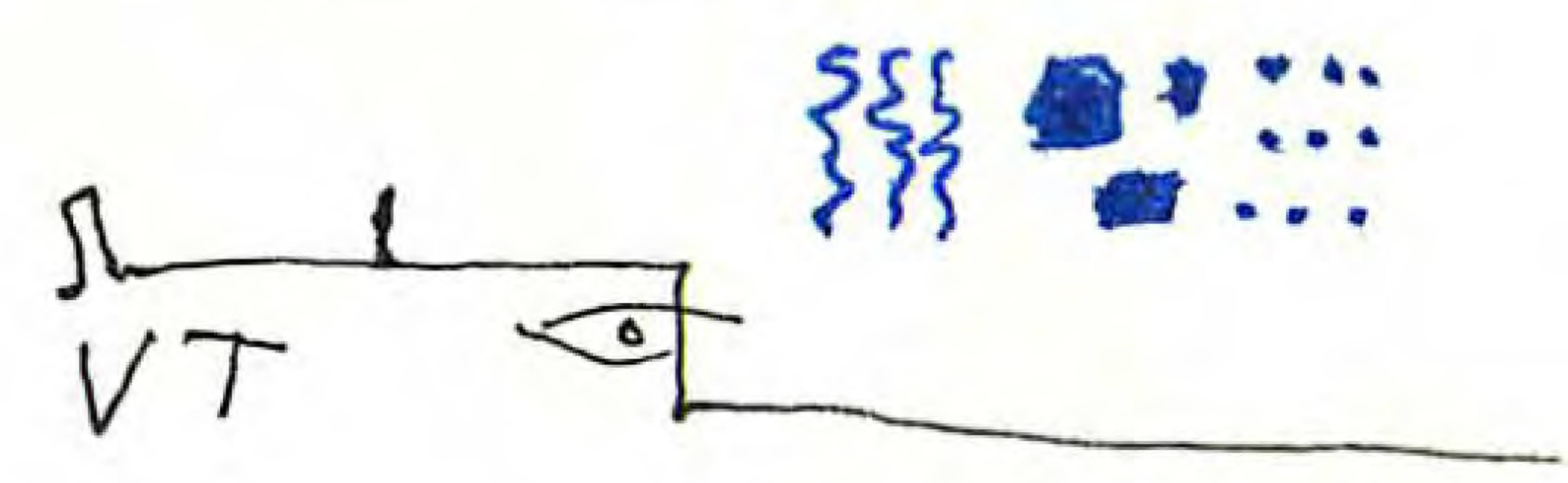

VT

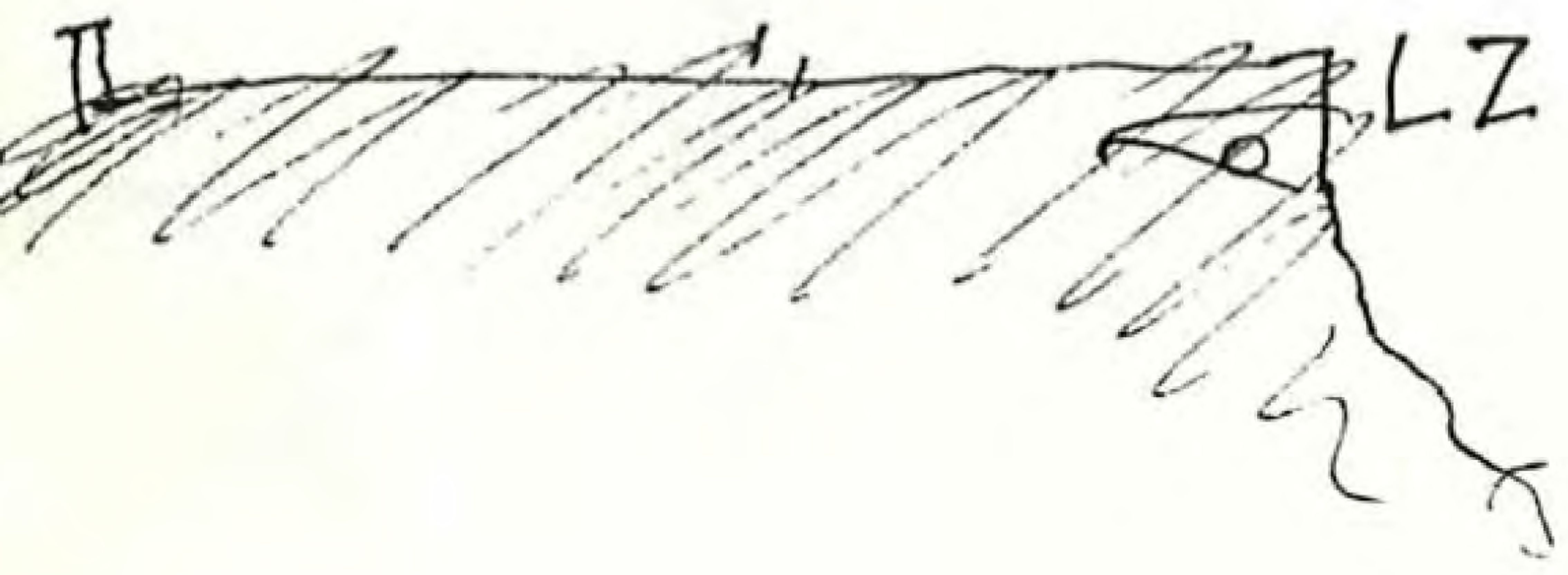

LZ



SA

131

Philip. NOYCE  
Suglia Tower

Jan 13 - 2011



COBQUECURA



VT



132

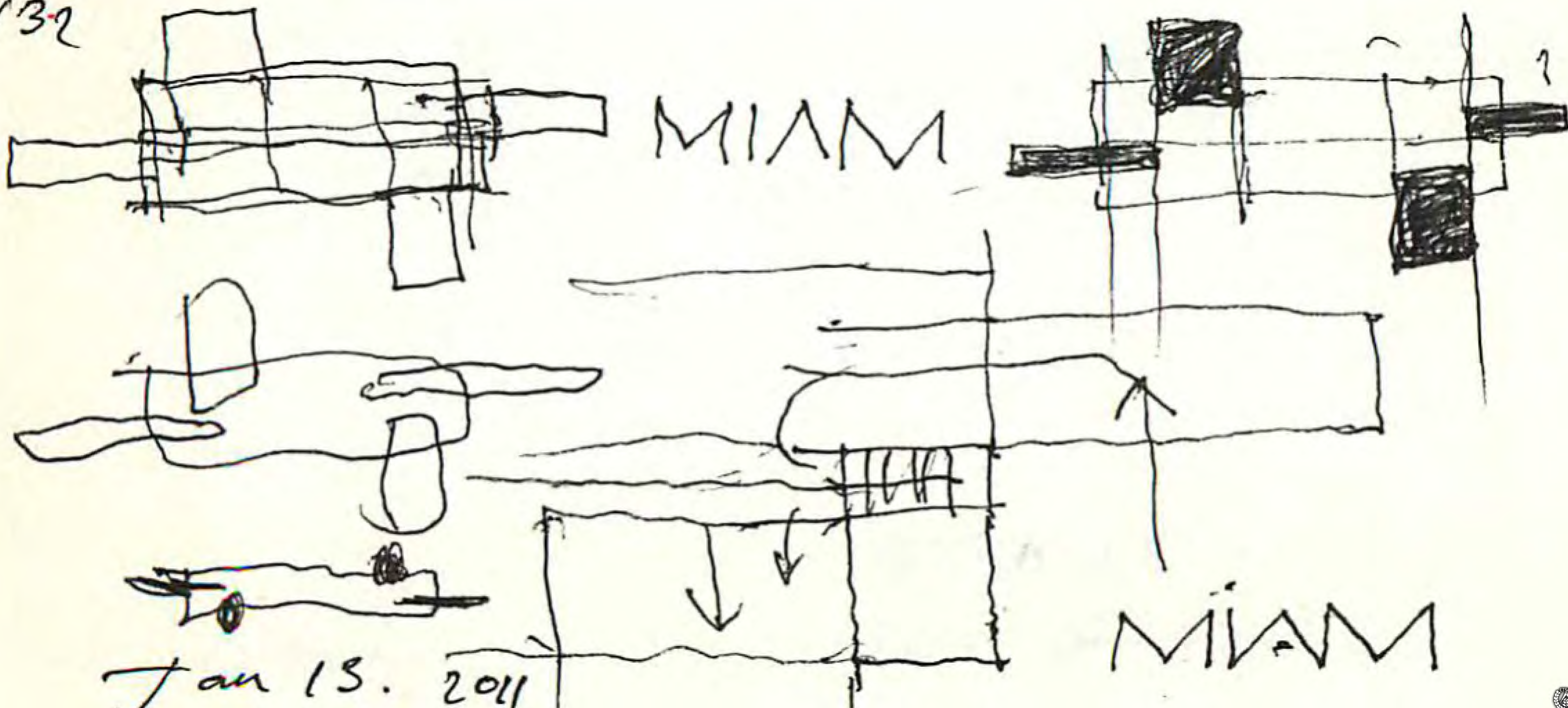

Jan 13. 2011

MIAM



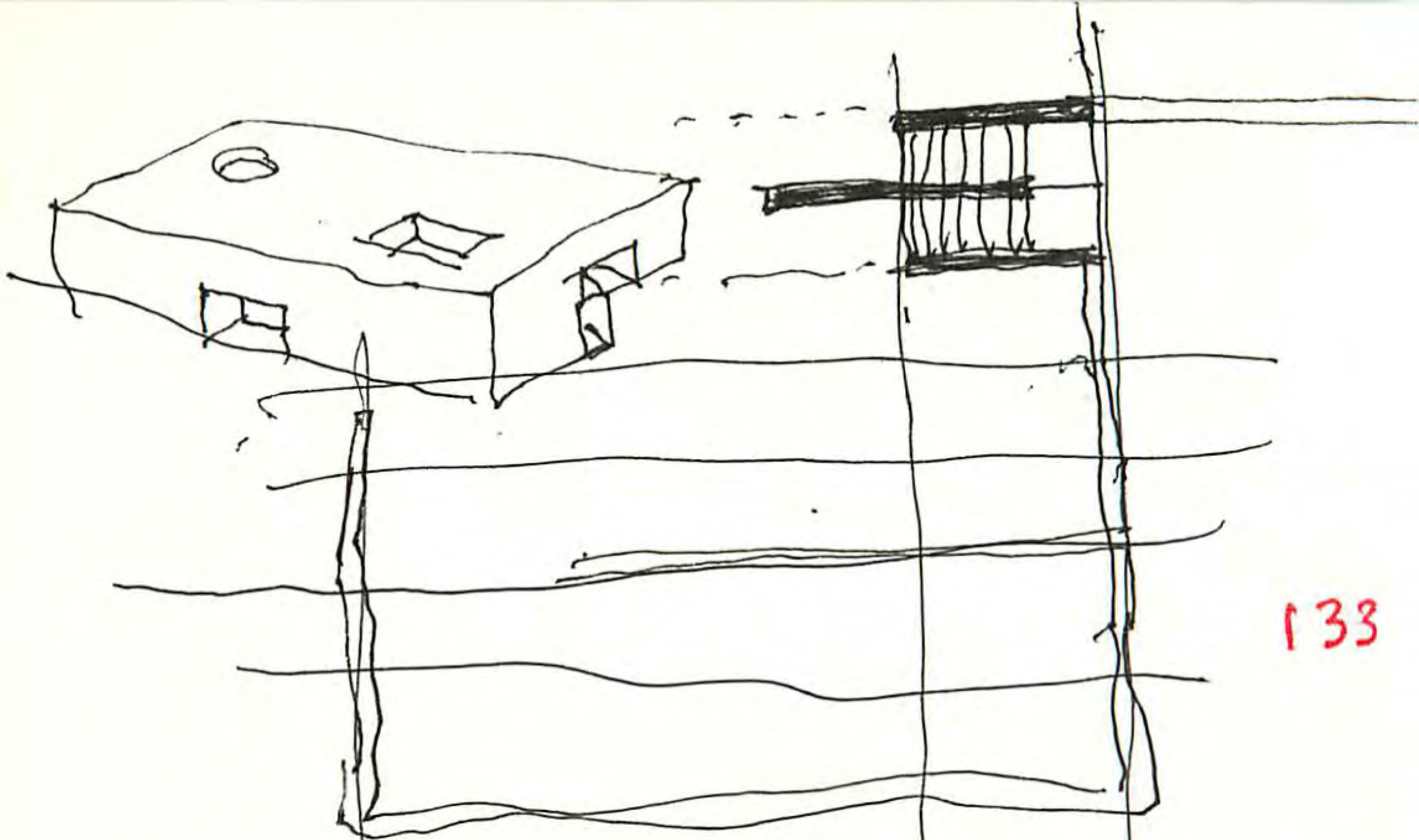

133

one more time  
the temptation of  
the only box

MIAM

Jan 13-2011 in the place

NY

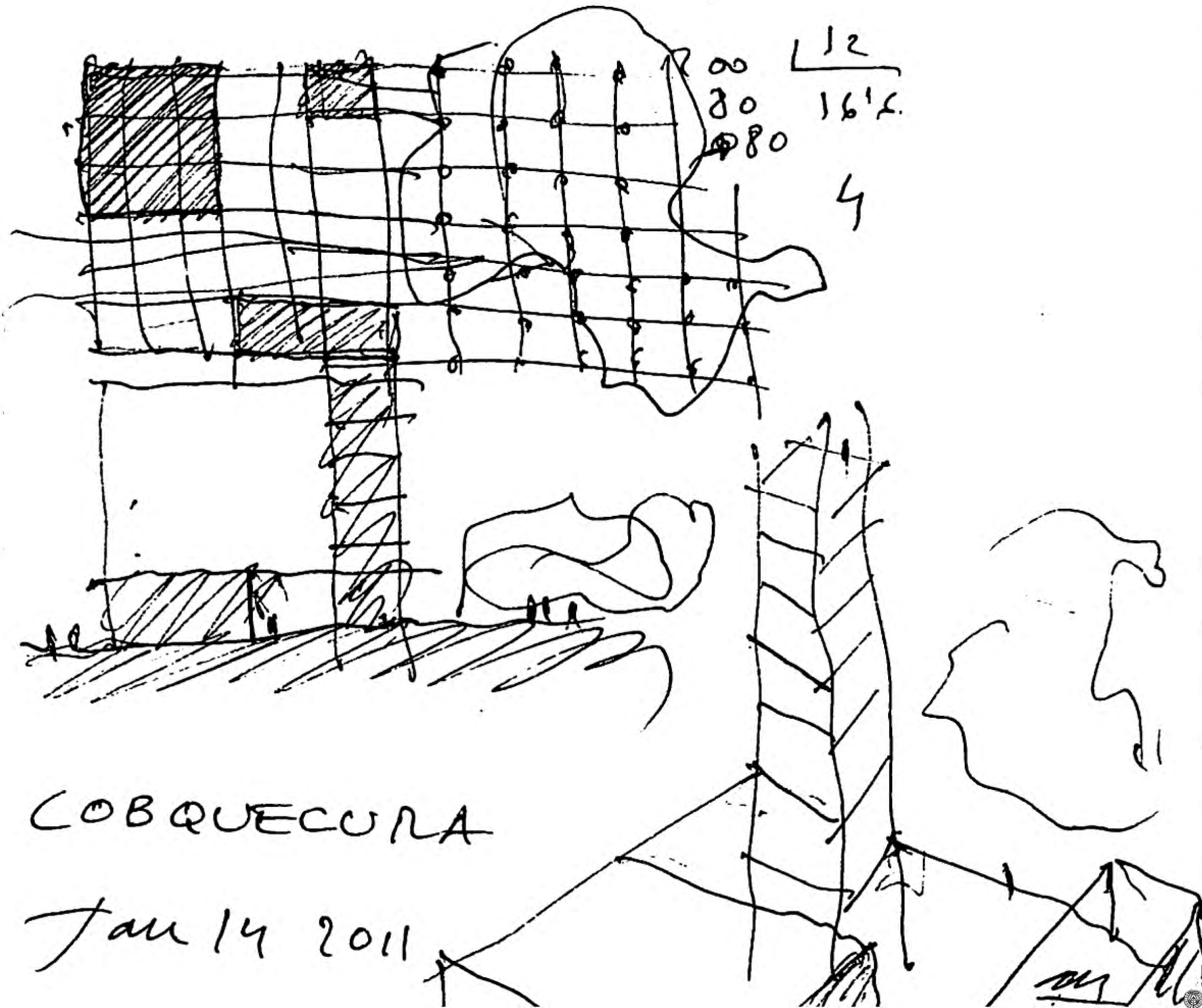

COBQUECORA

Jan 14 2011

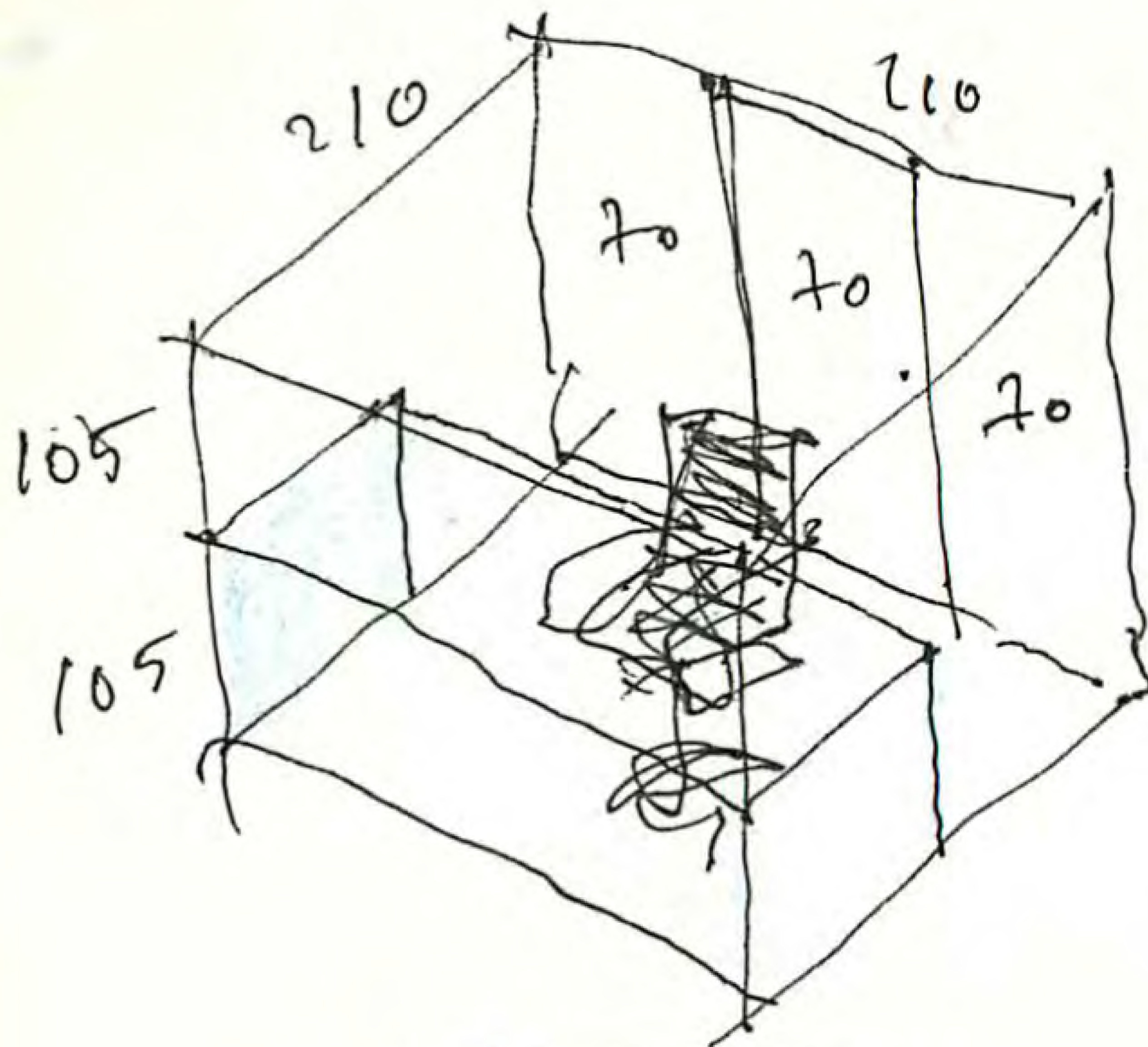

210 270 x 210

solo con  
 filicoua  
 estructural.  
 + laves

135

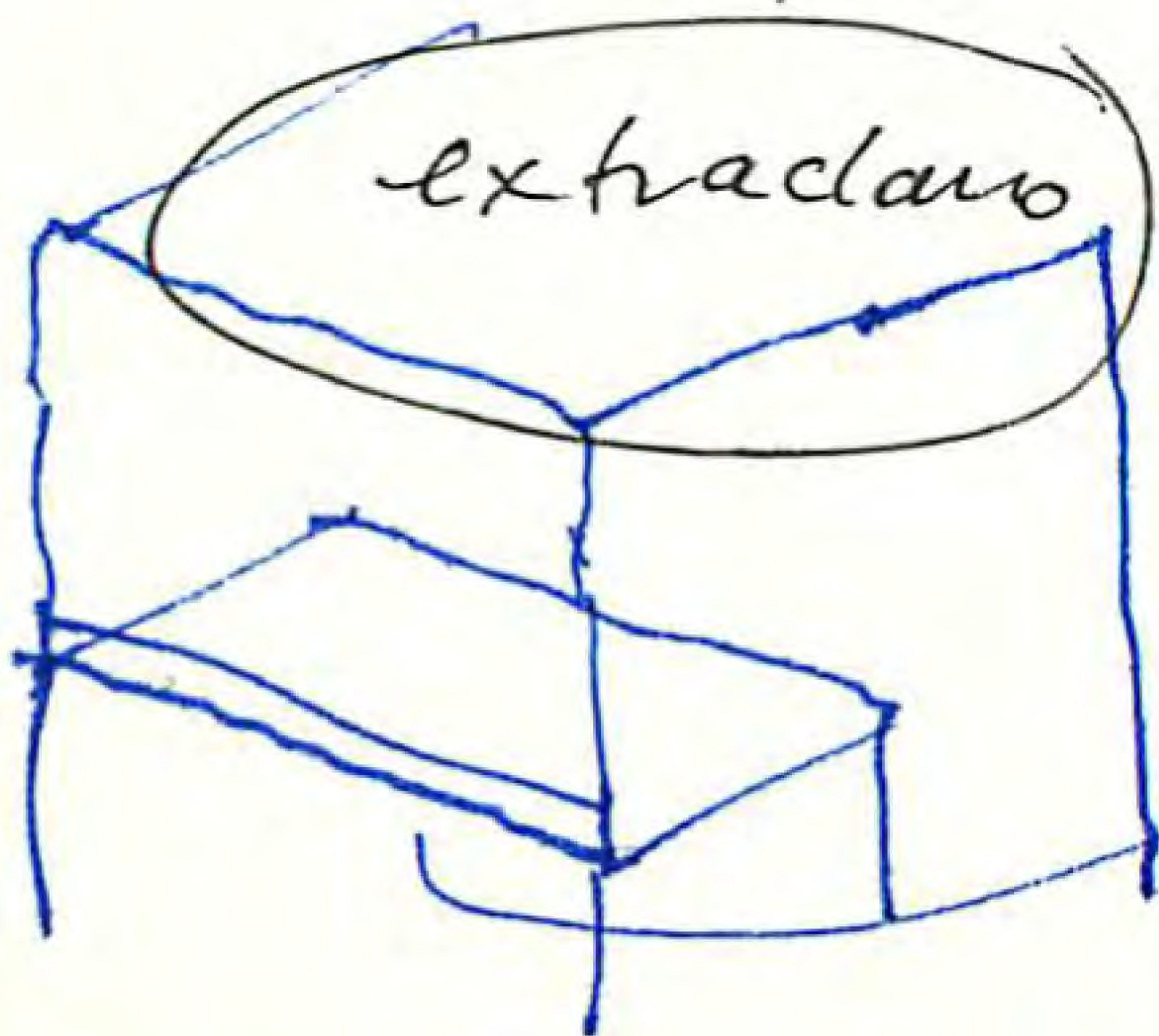

+ vitilo blanco.  
 (o pintura blanca)

→ raja completa.  
 contra (blanca:  
 inox



ZA.

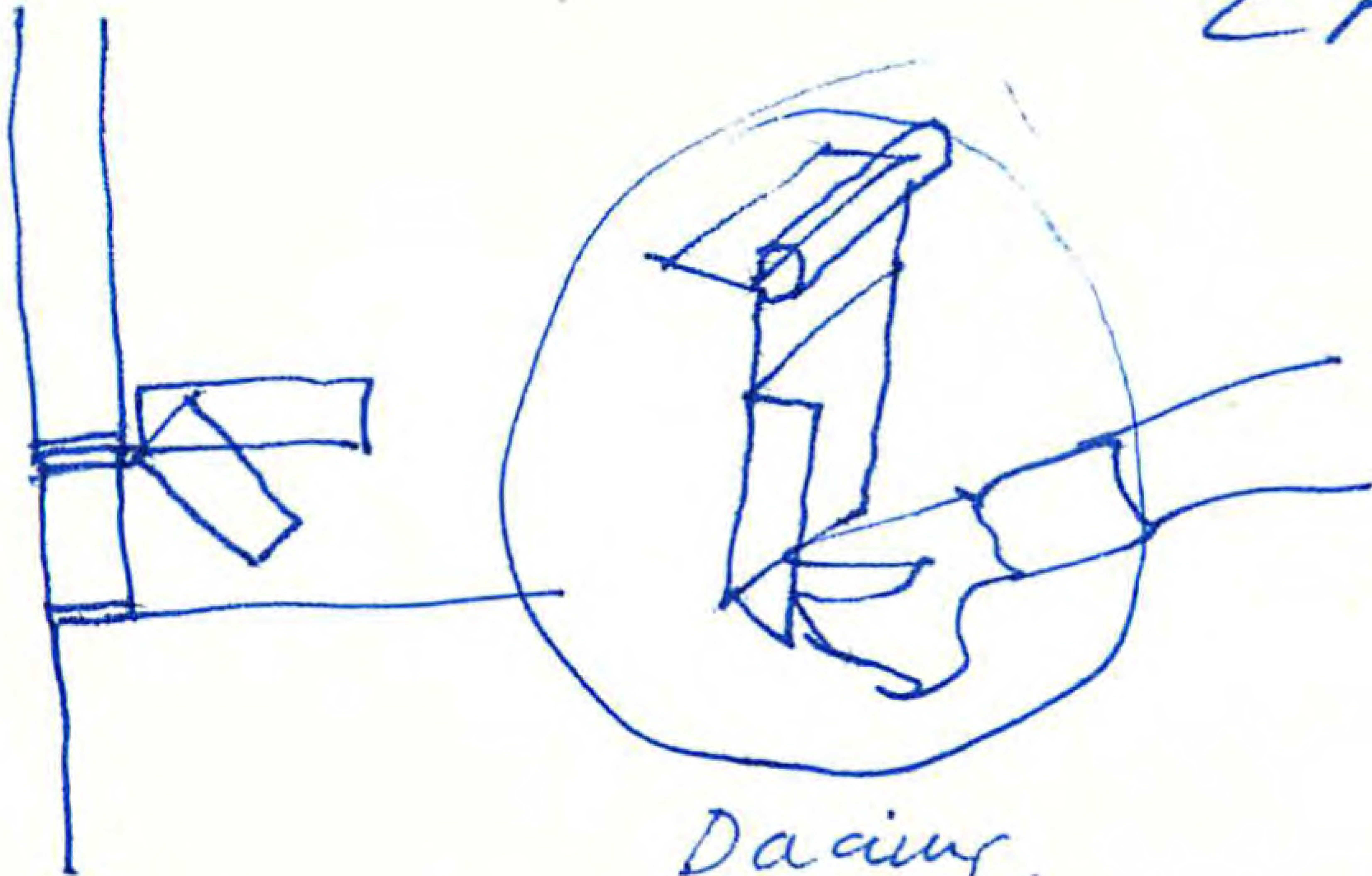

137

Dacing.

TAPA  
RAJITA  
CUBO ZAMORA

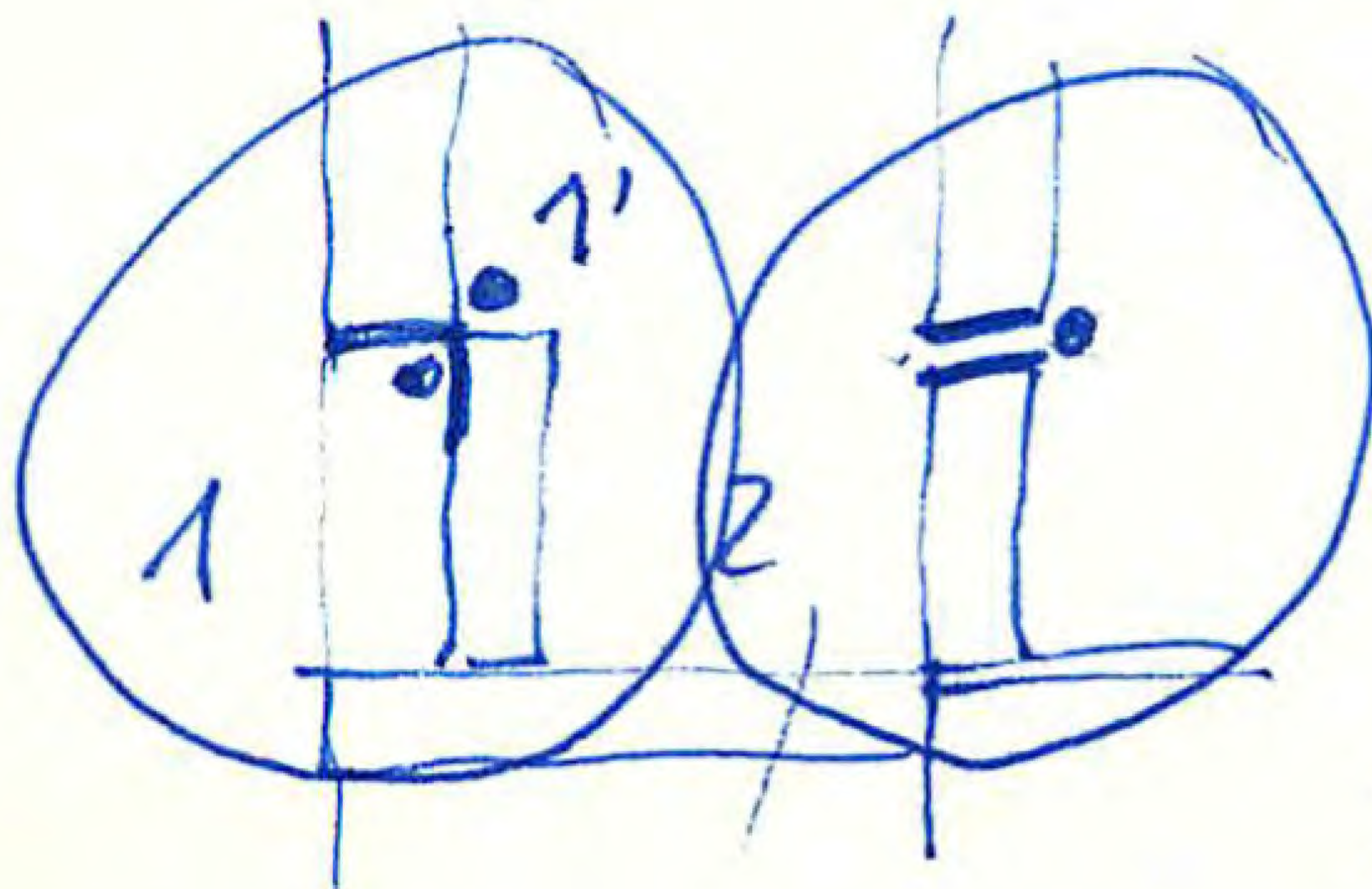

Jan. 19 2011 *My*

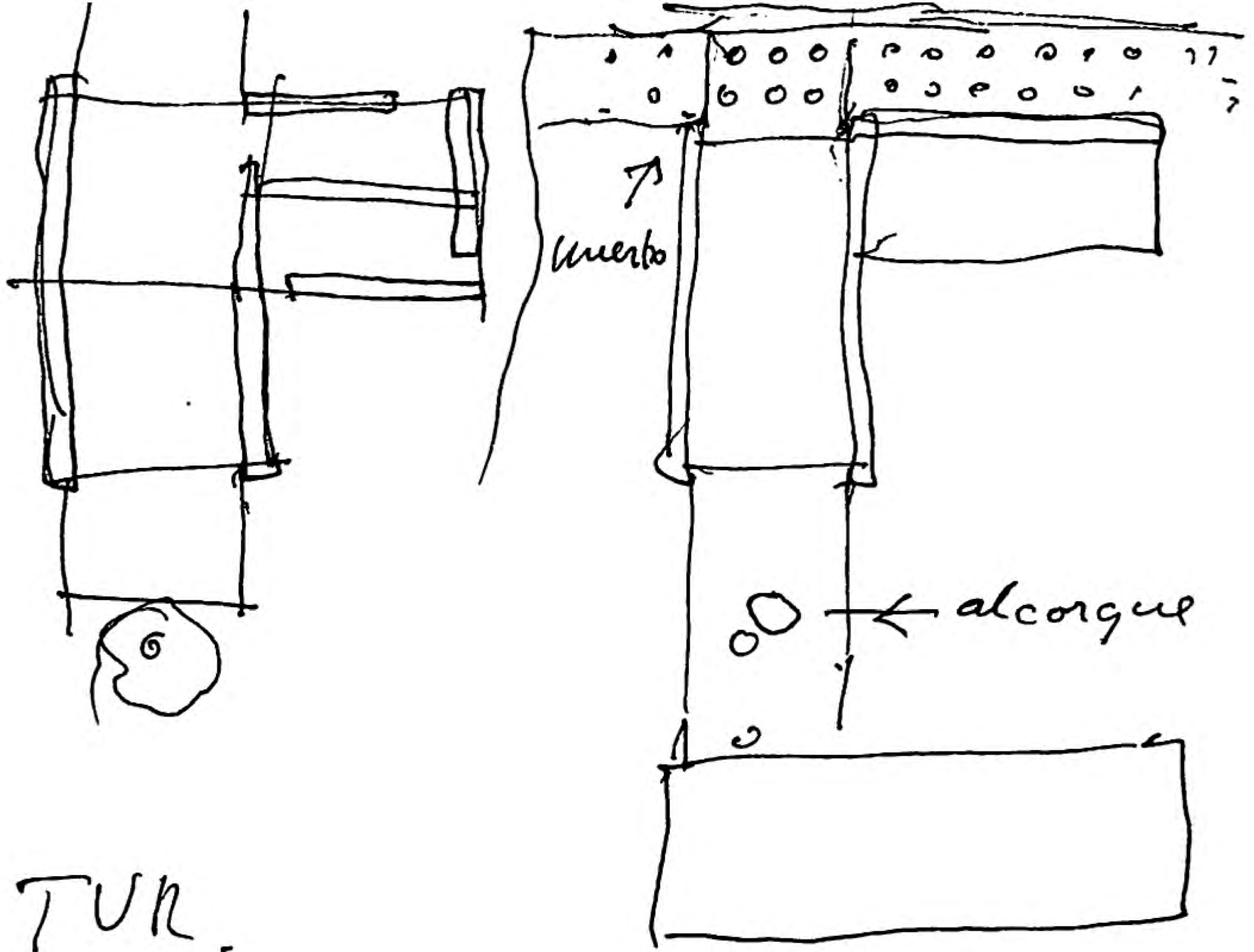

TUR.

muerto  
 + fuelle perforado.)  
 Tam. 1a / 2011.

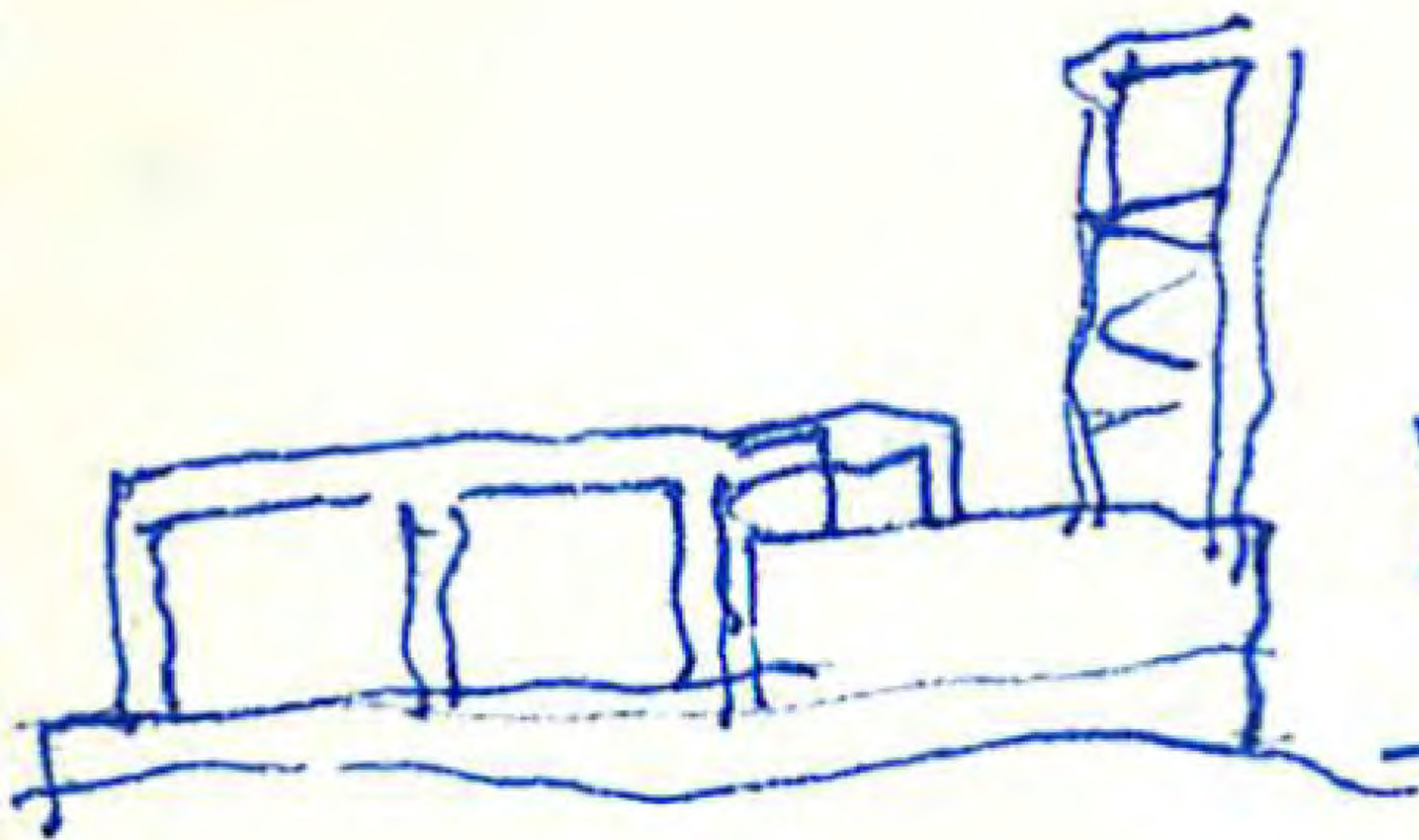

C'OBQUECURA

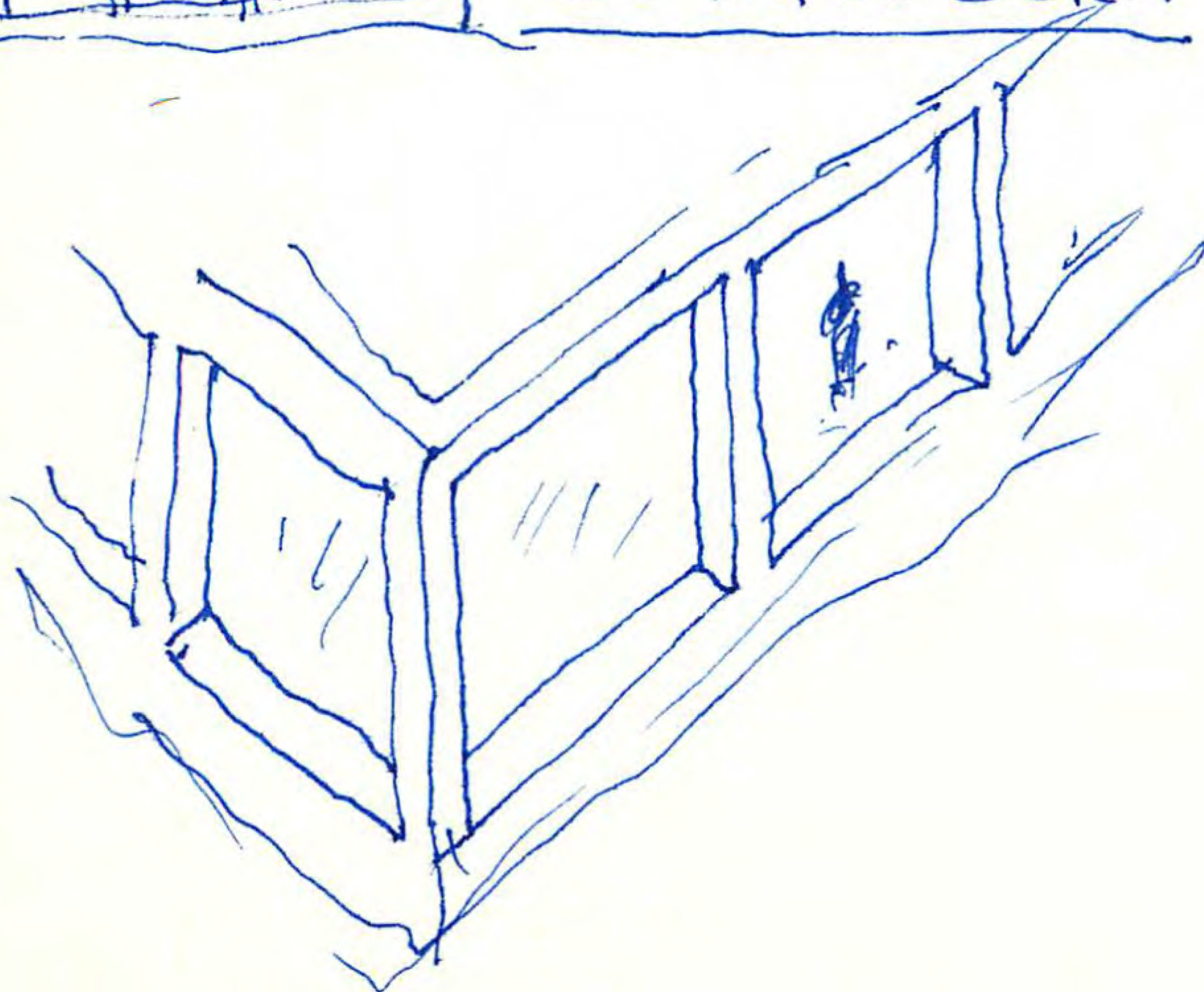

139

# TEXTO CANTICAGE

en todos los textos hacen con planeación y general.

Una segunda parte (AC FINAL)  
con el caso de este proyecto.

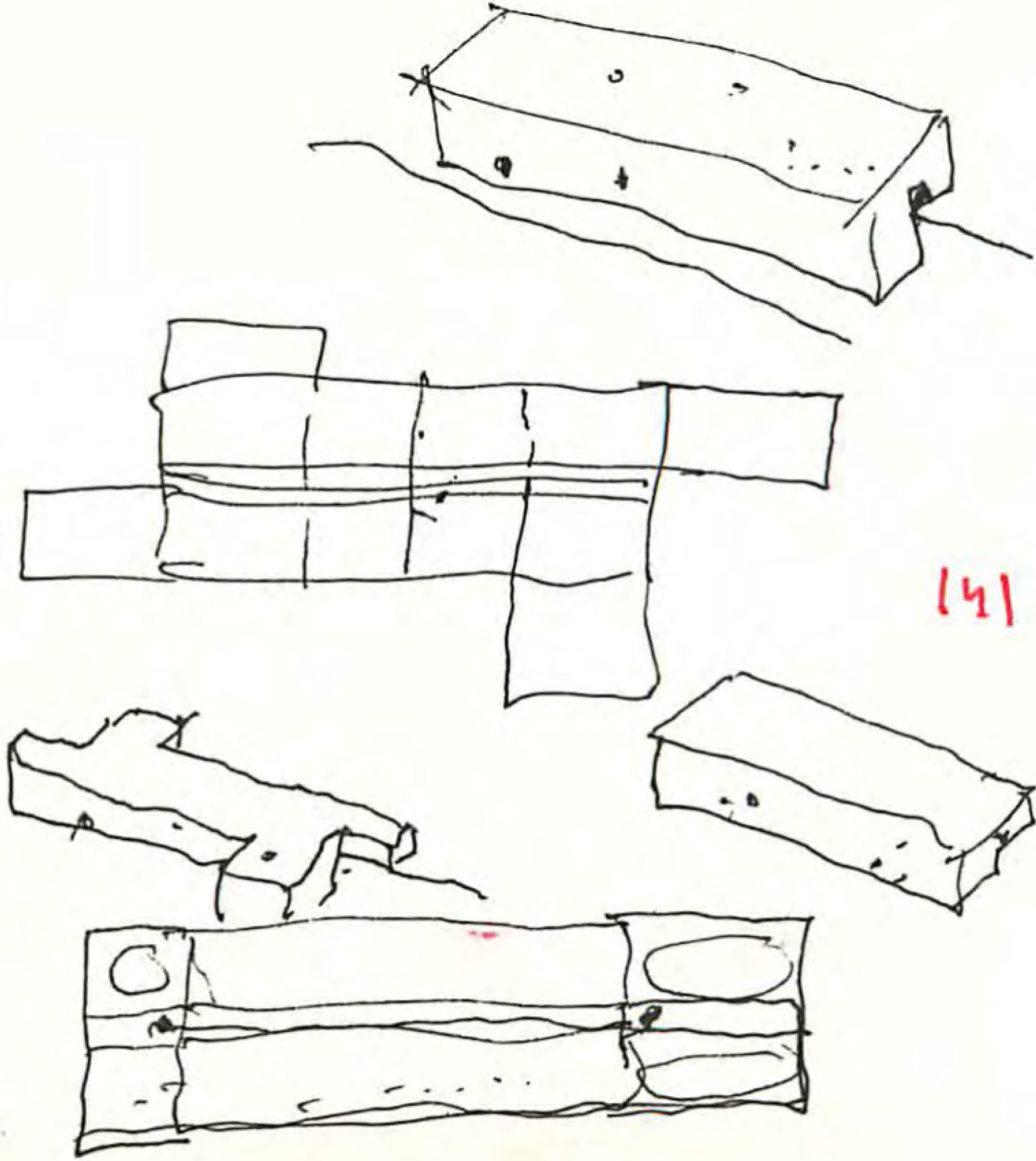

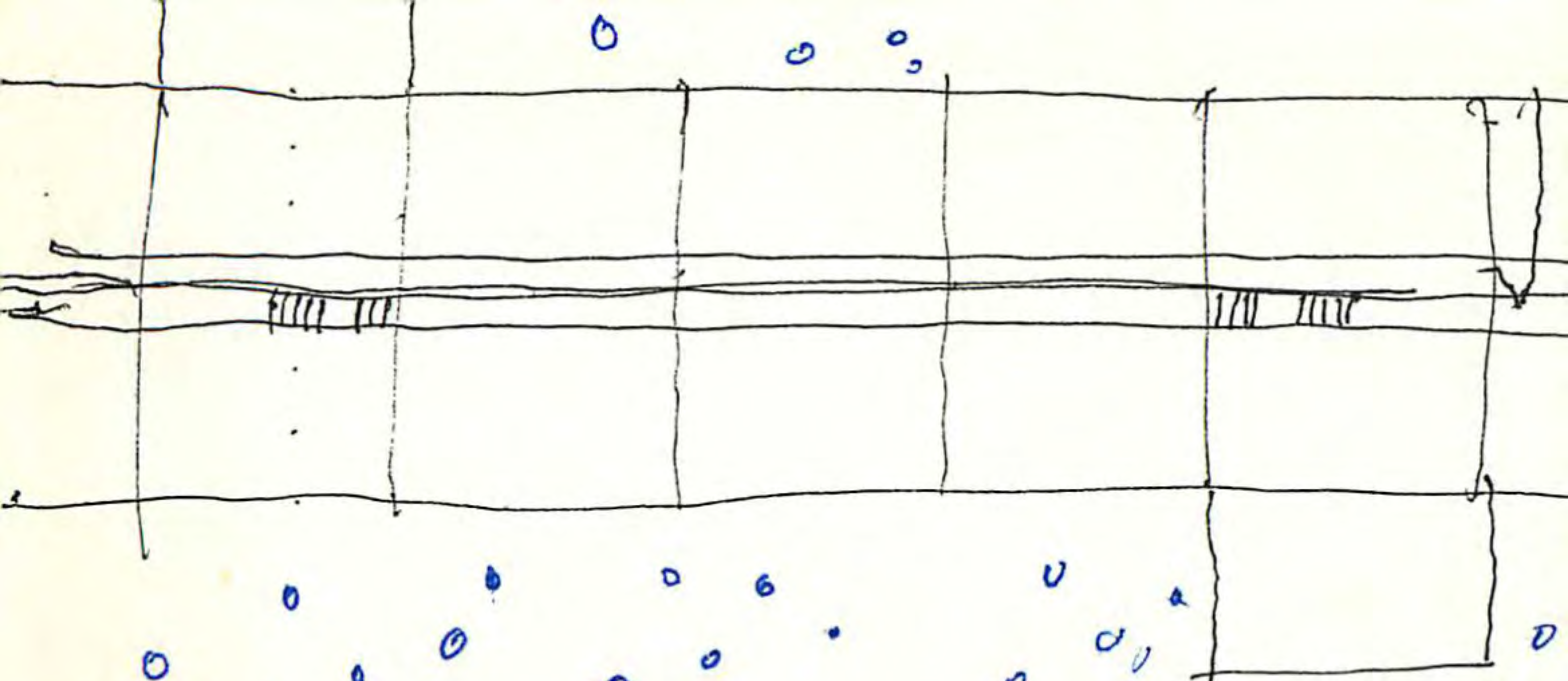

142

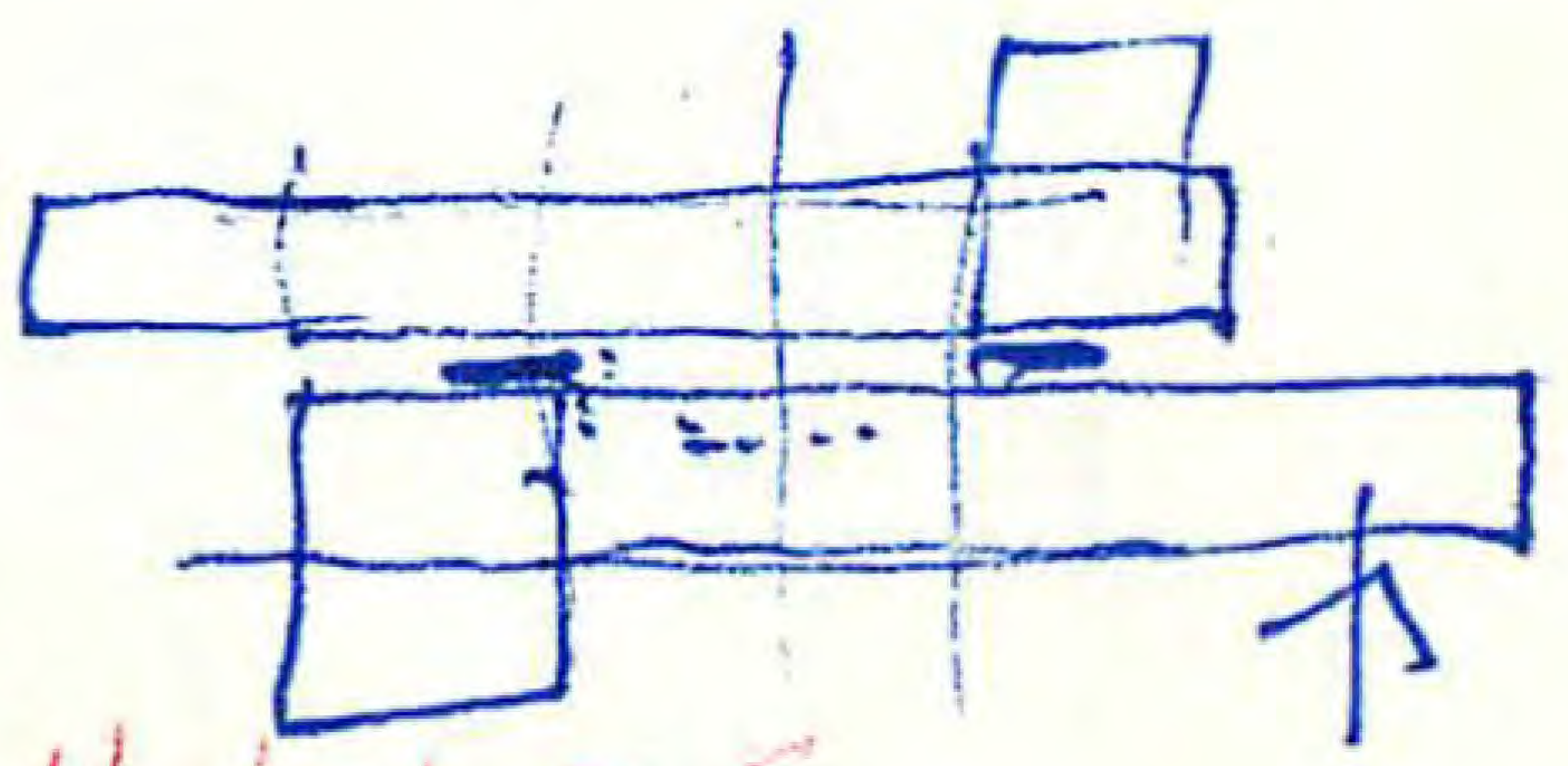
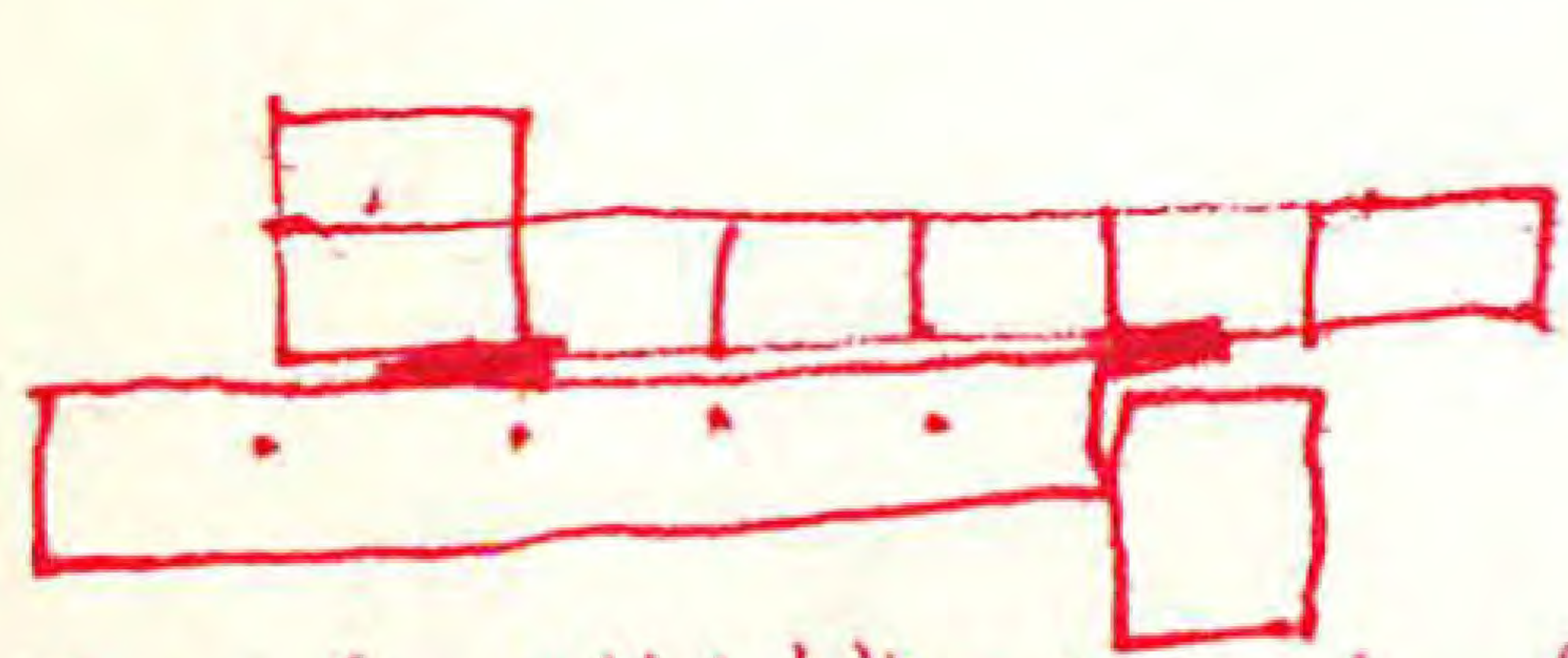

Jan 21, 2014 - Columbia U NY.



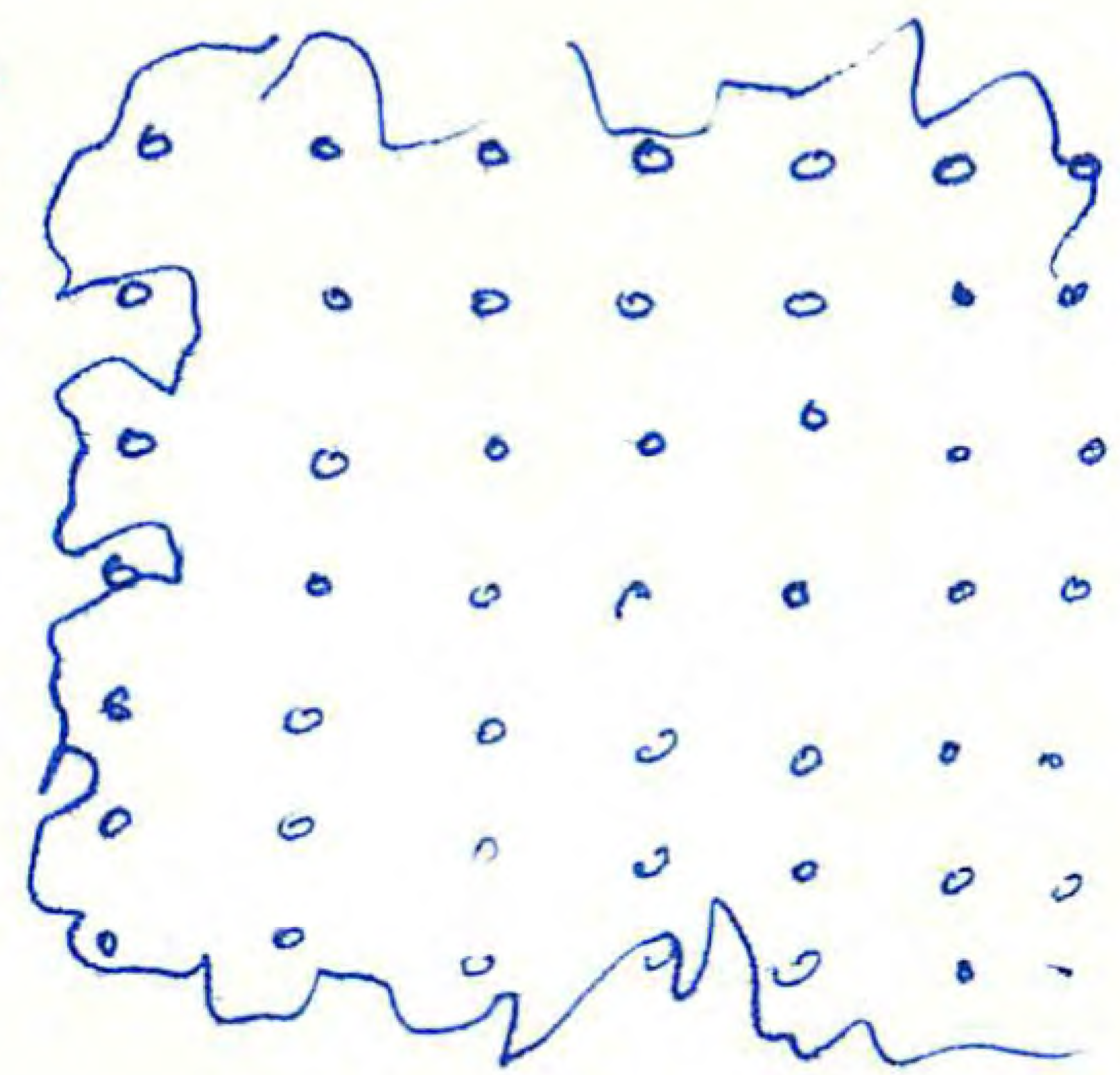
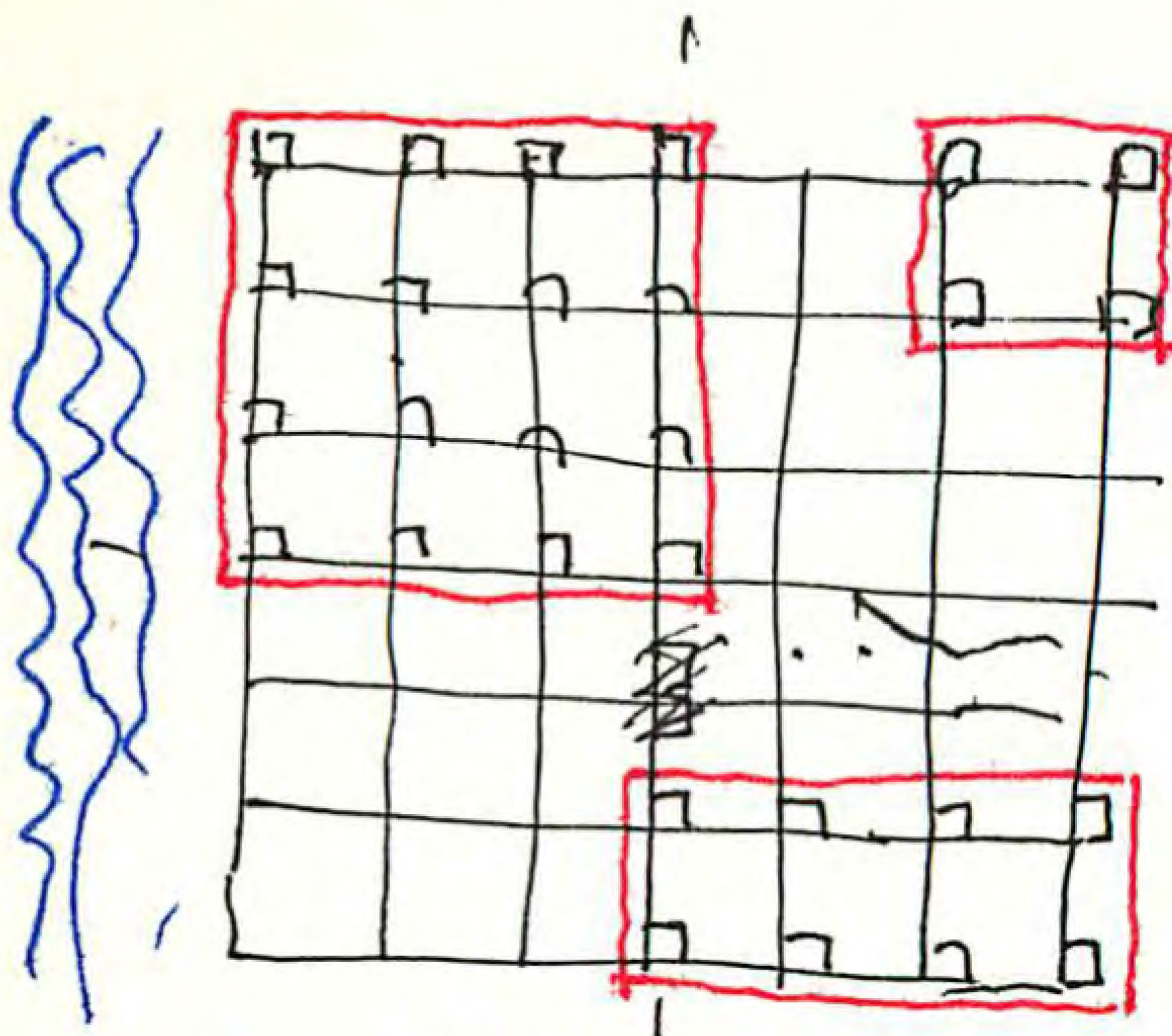

COBQUECURA.  
CHILE

143



Jan. 21. 2011. en Columbia. NY

TUR

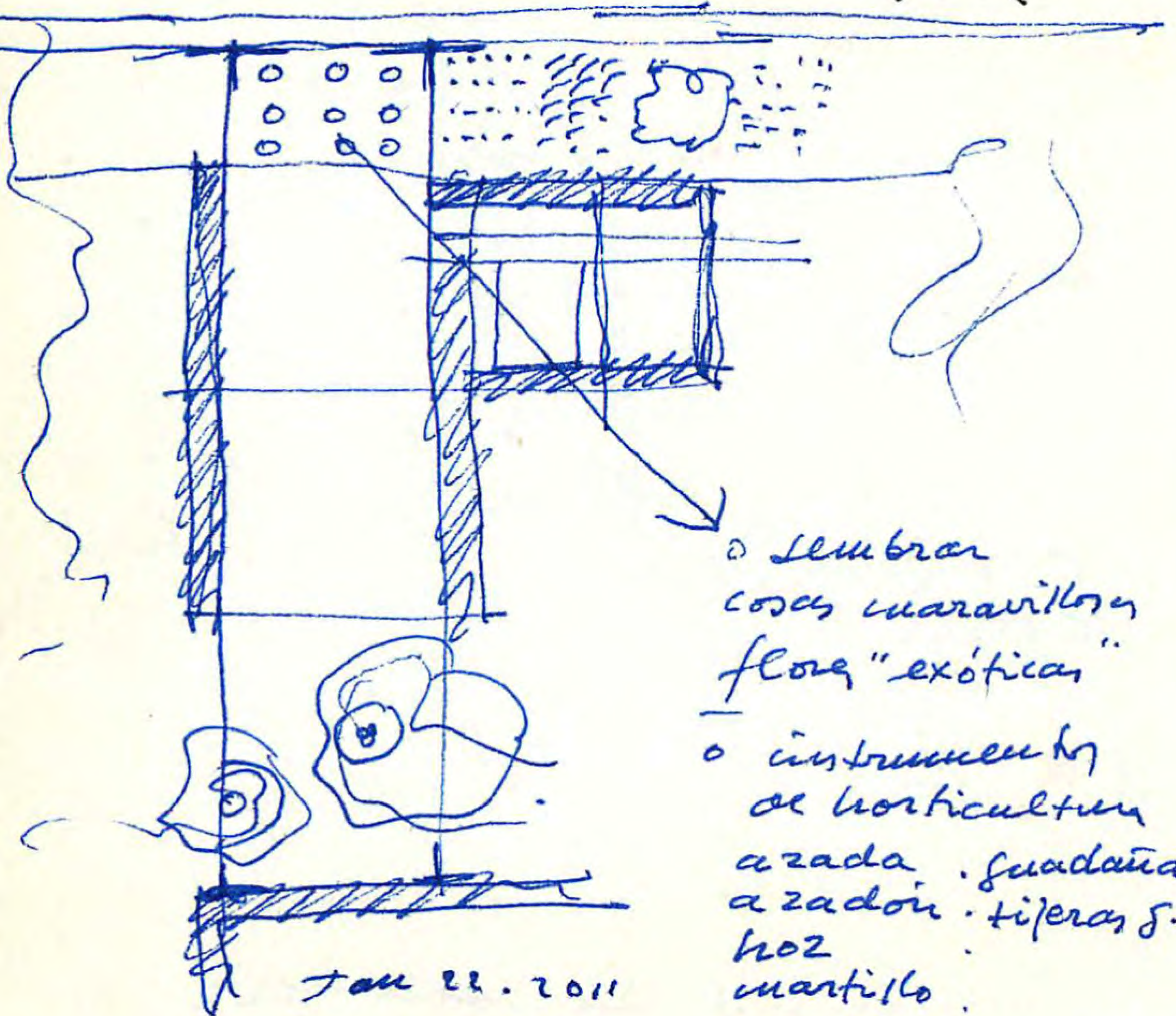

- o sembrar cosas maravillosas flores "exóticas"
- o instrumentos de horticultura azada, guadaña, azadón, tijeras, hoz, martillo.

Jan 22. 2011

MIA

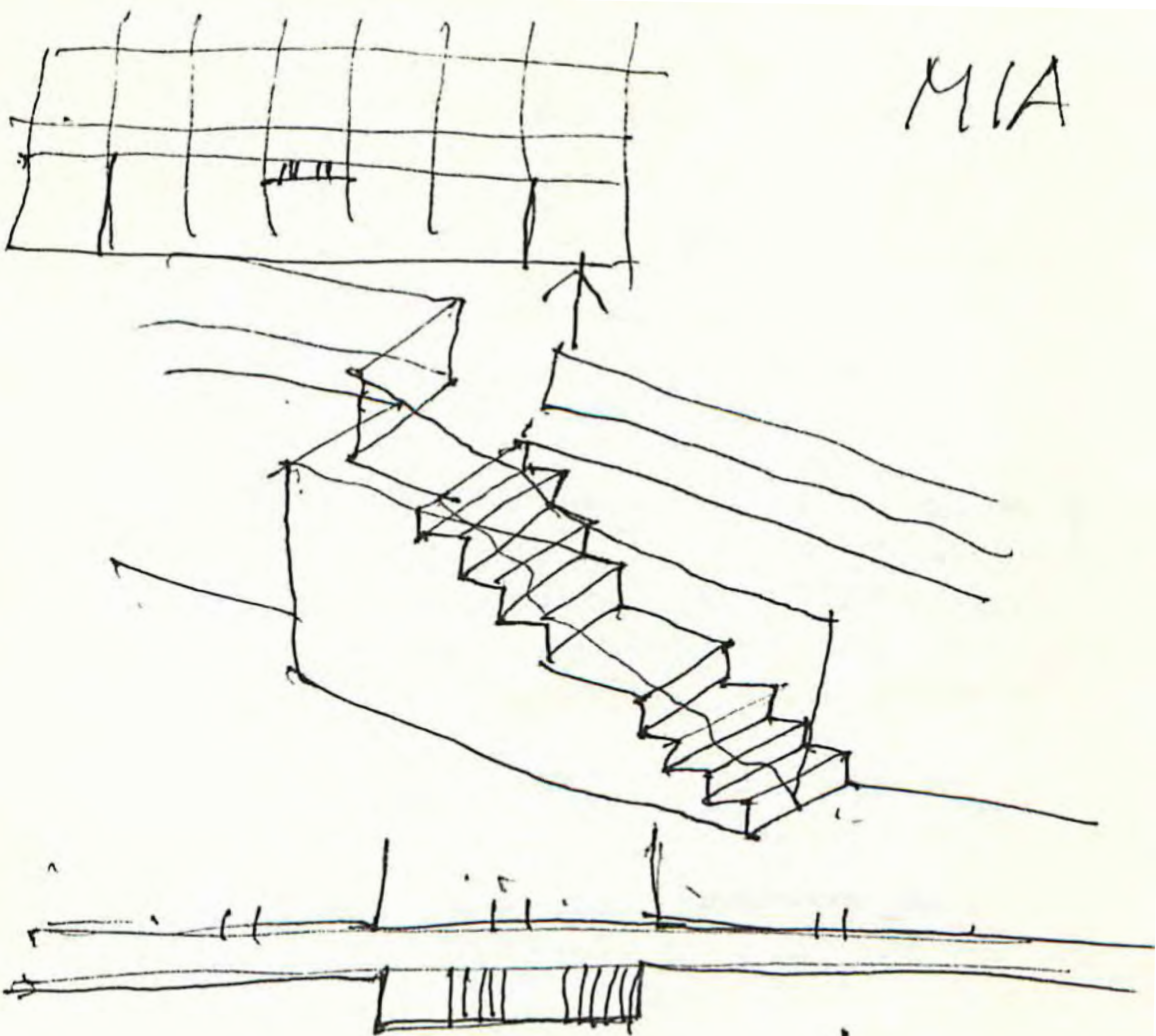

June 26 2011

146

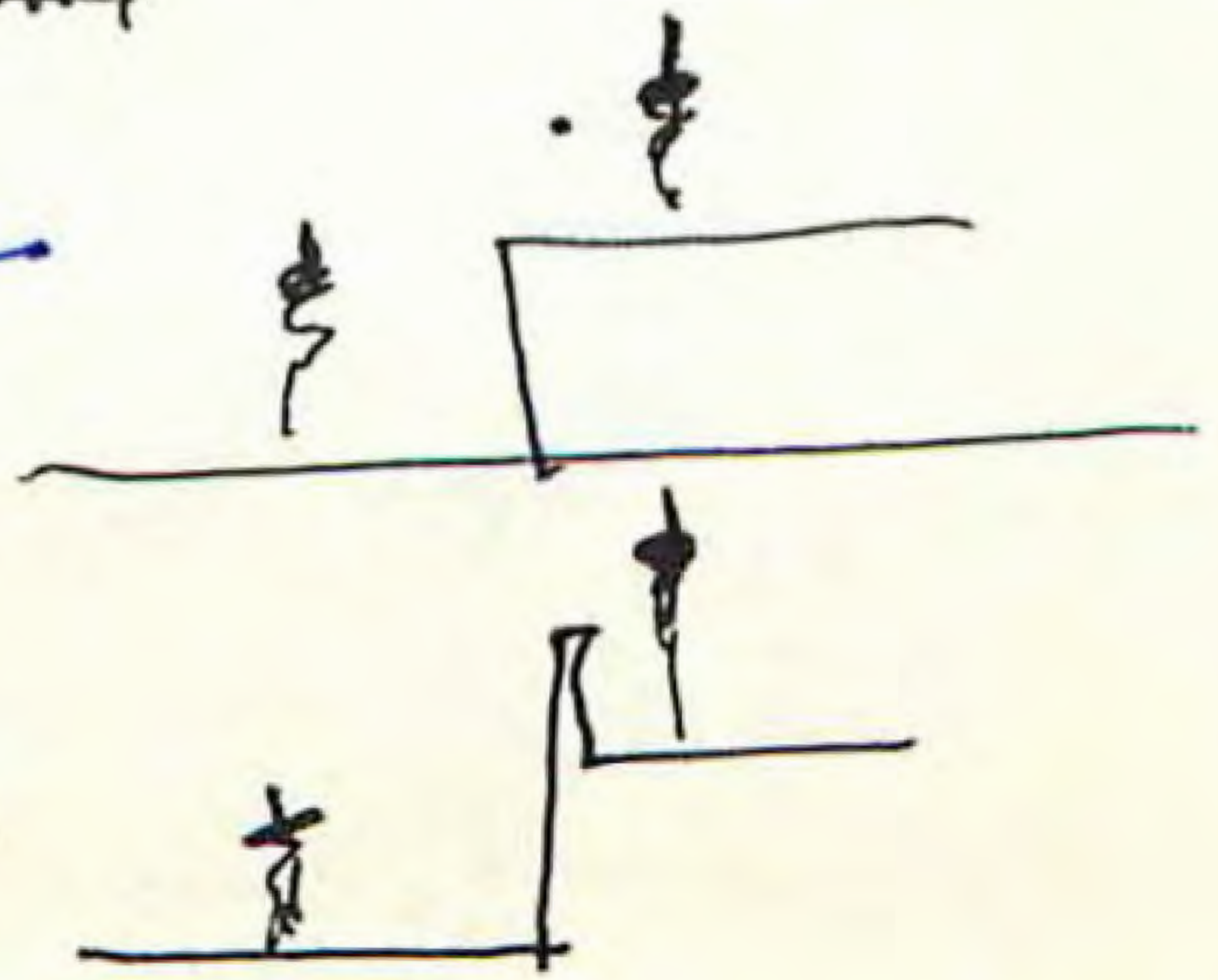

MIA

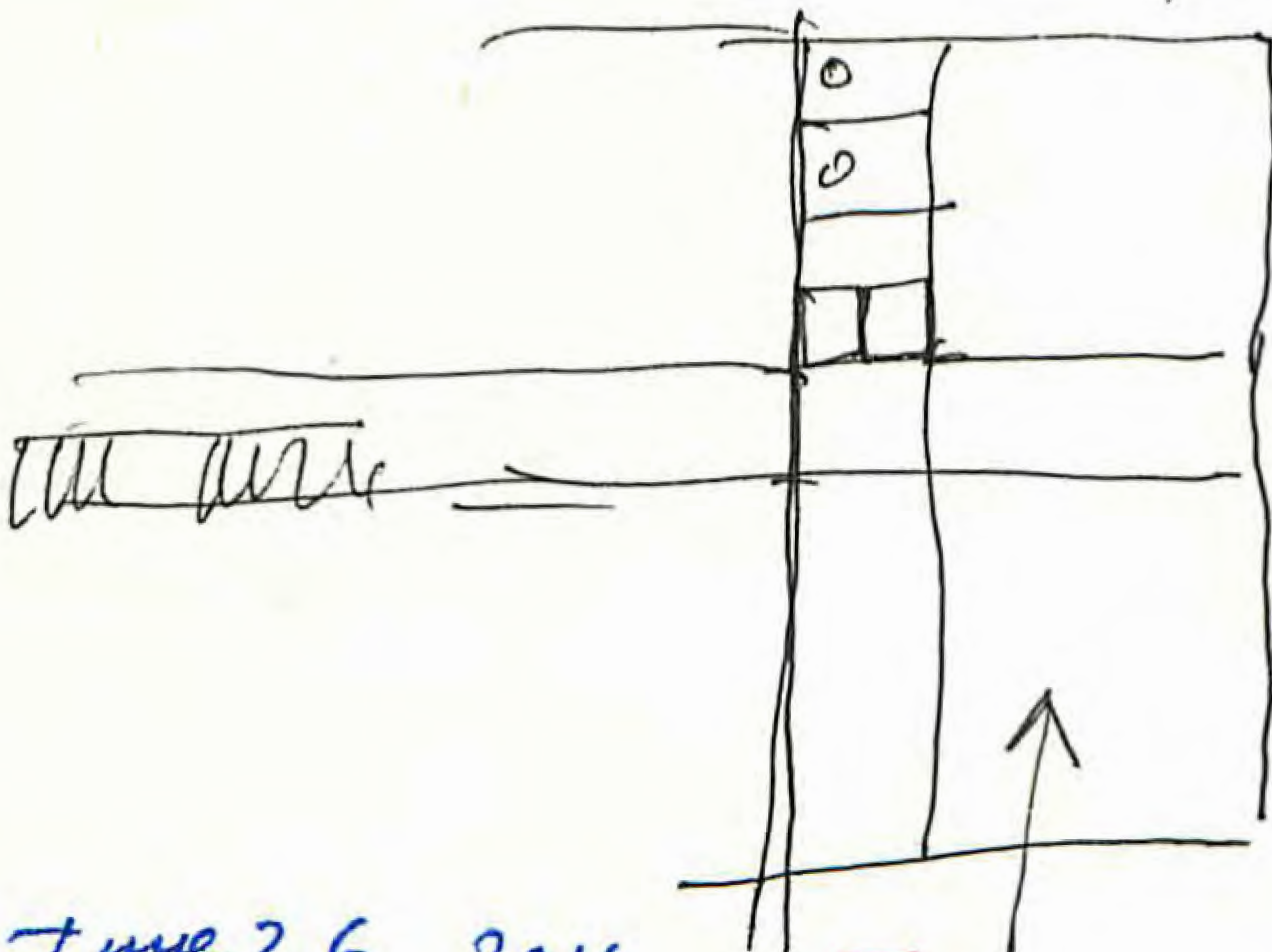
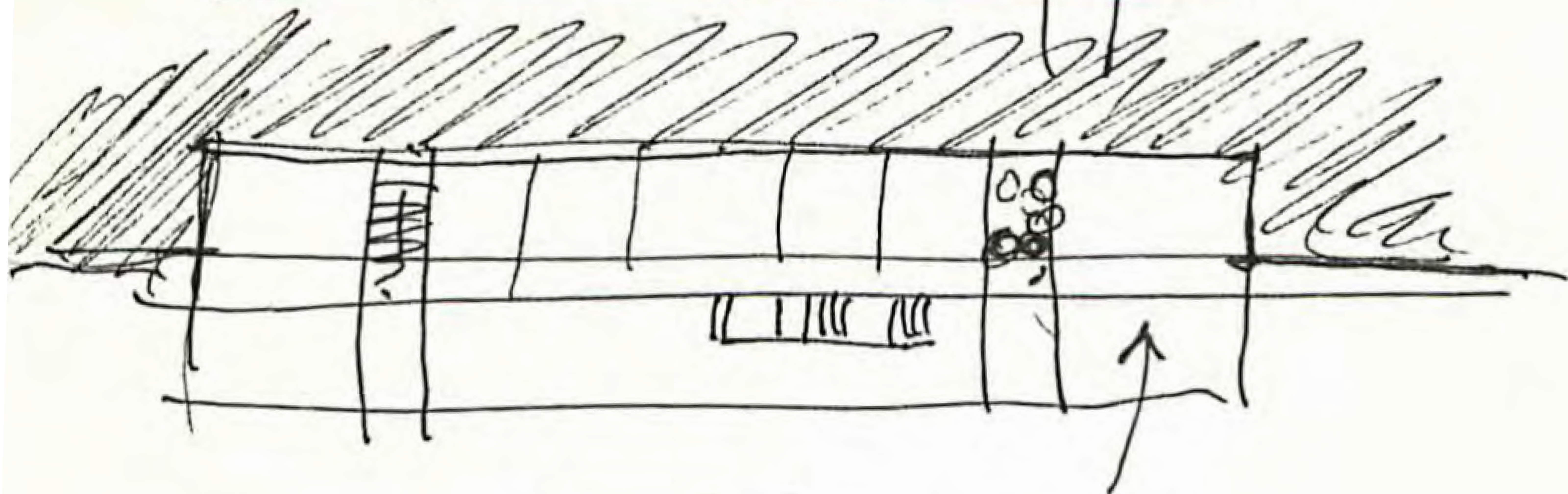
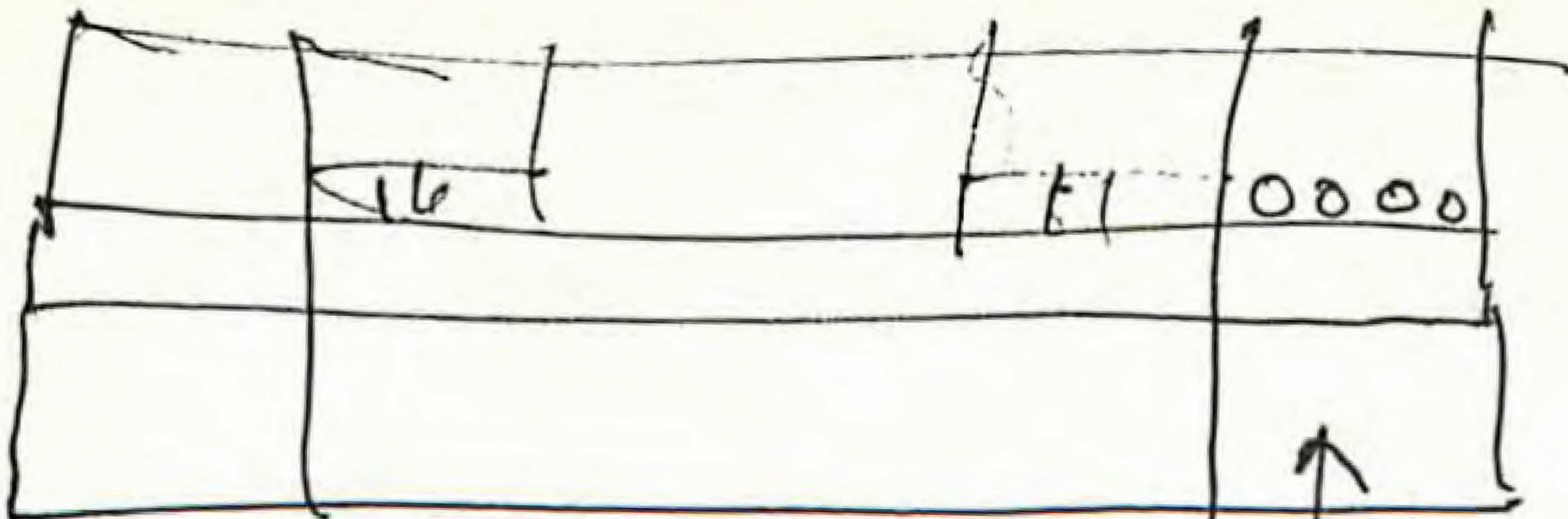

June 26 2011

14x



2



Jan 27. 2011

149

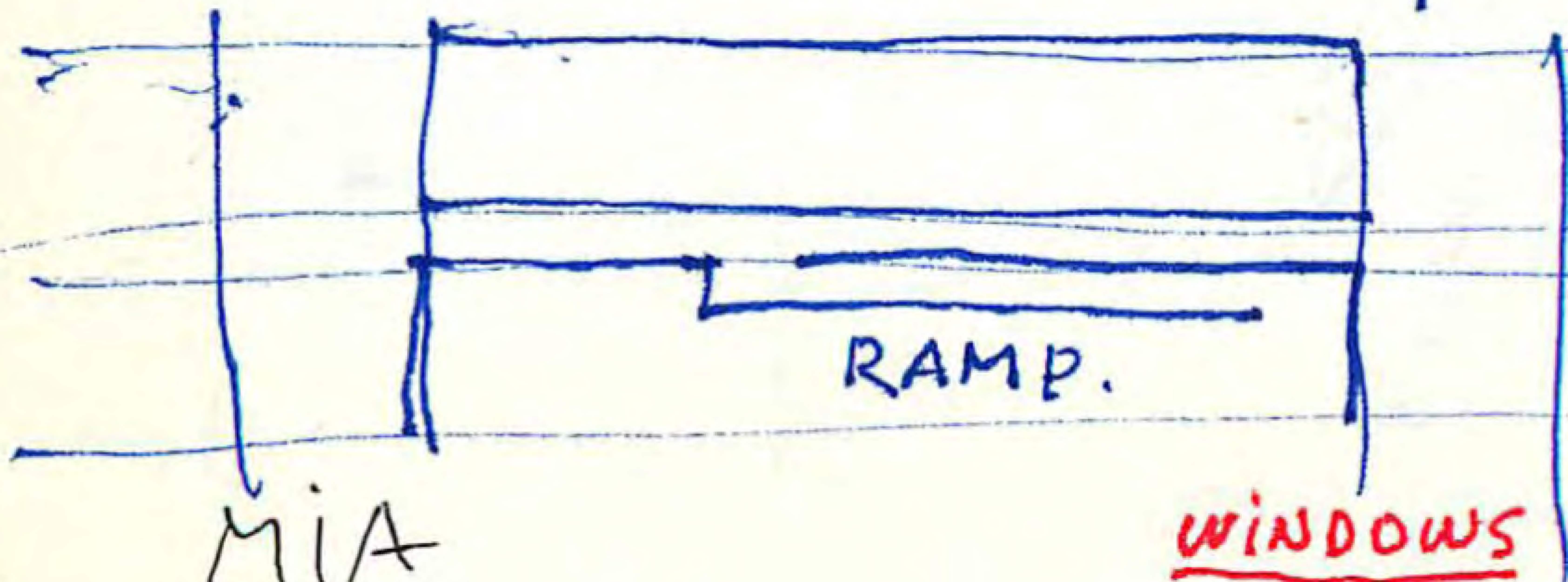
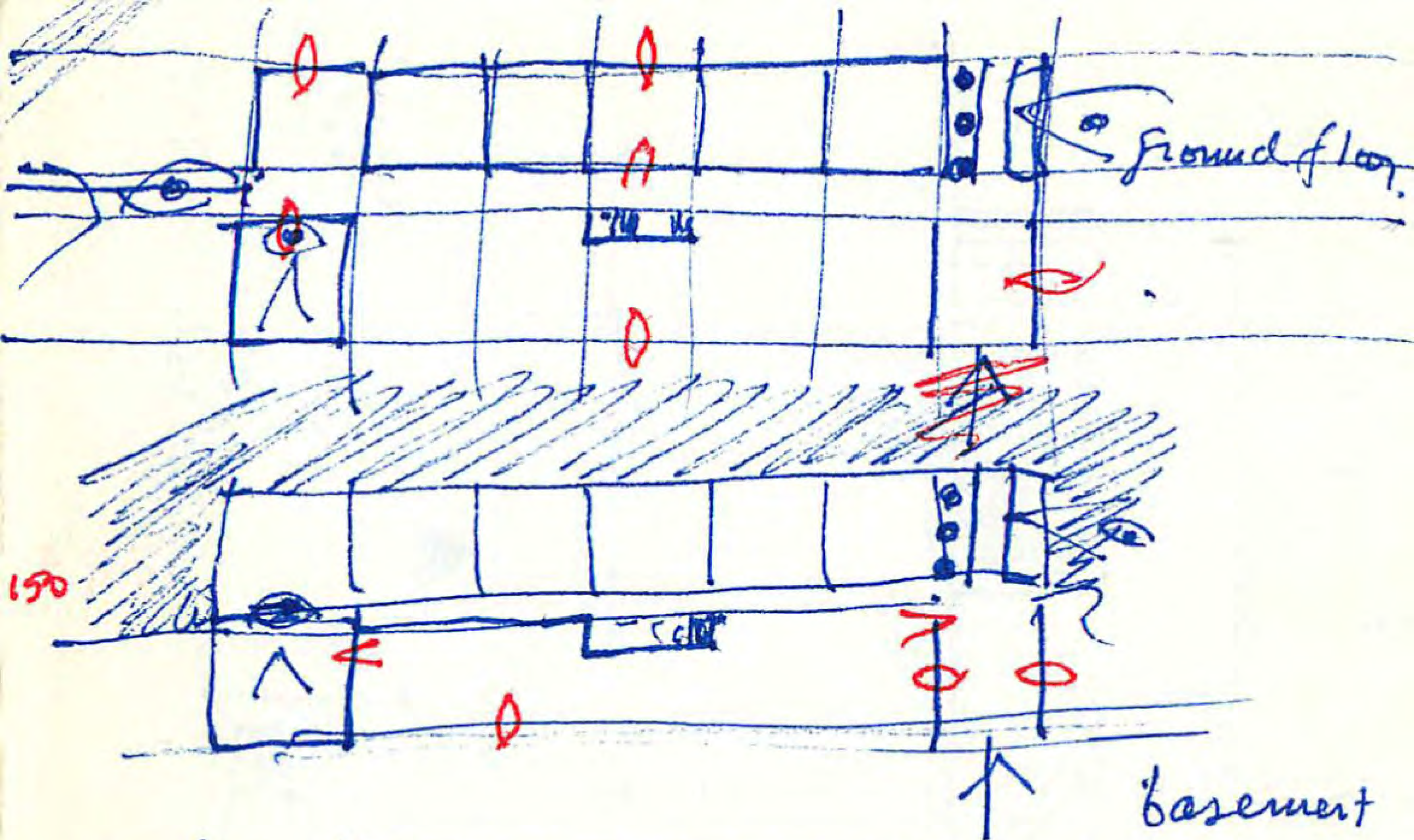

The BOX  
is NOT  
so tall!

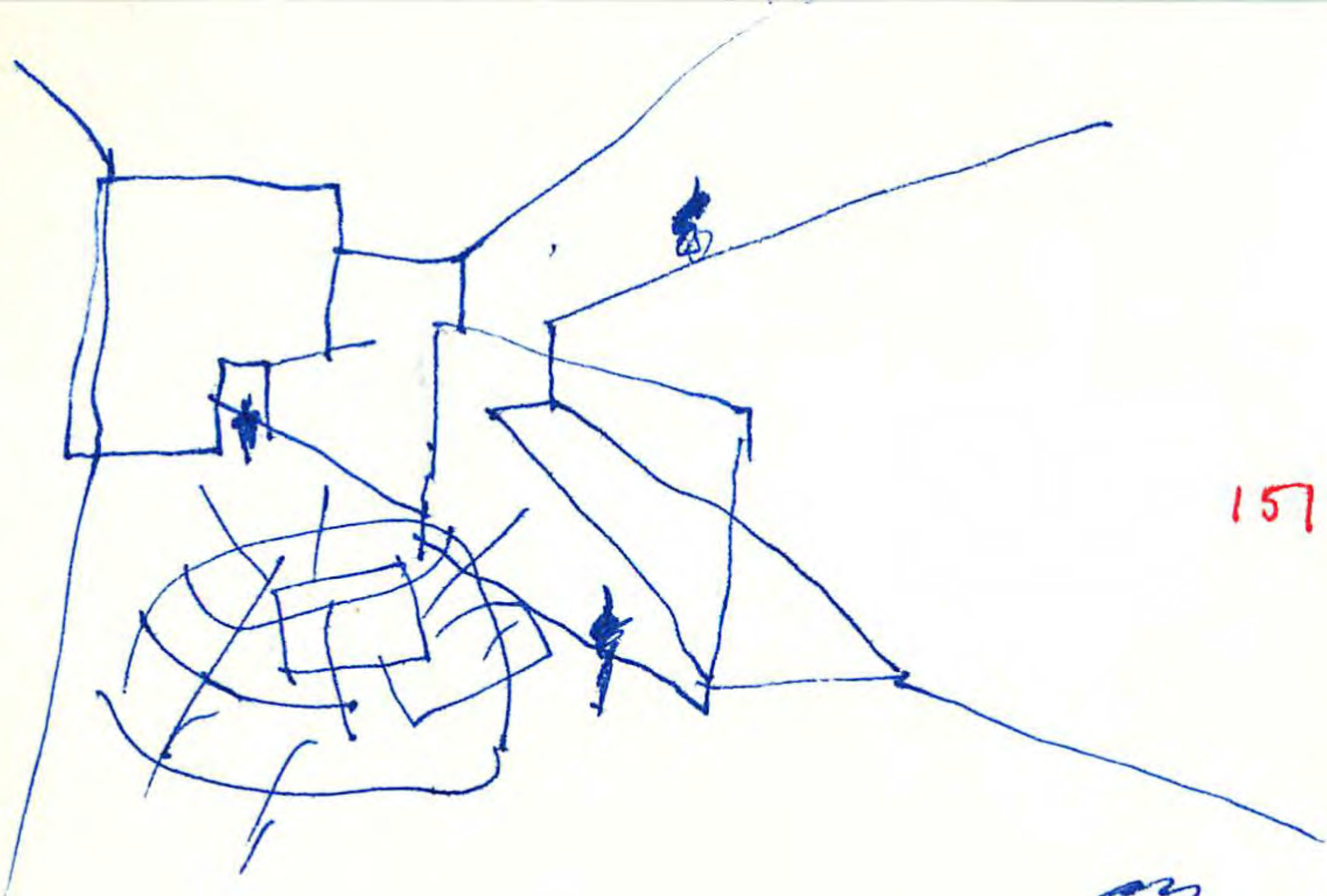

157

for  
January 27, 2011  
MIA.

MIA

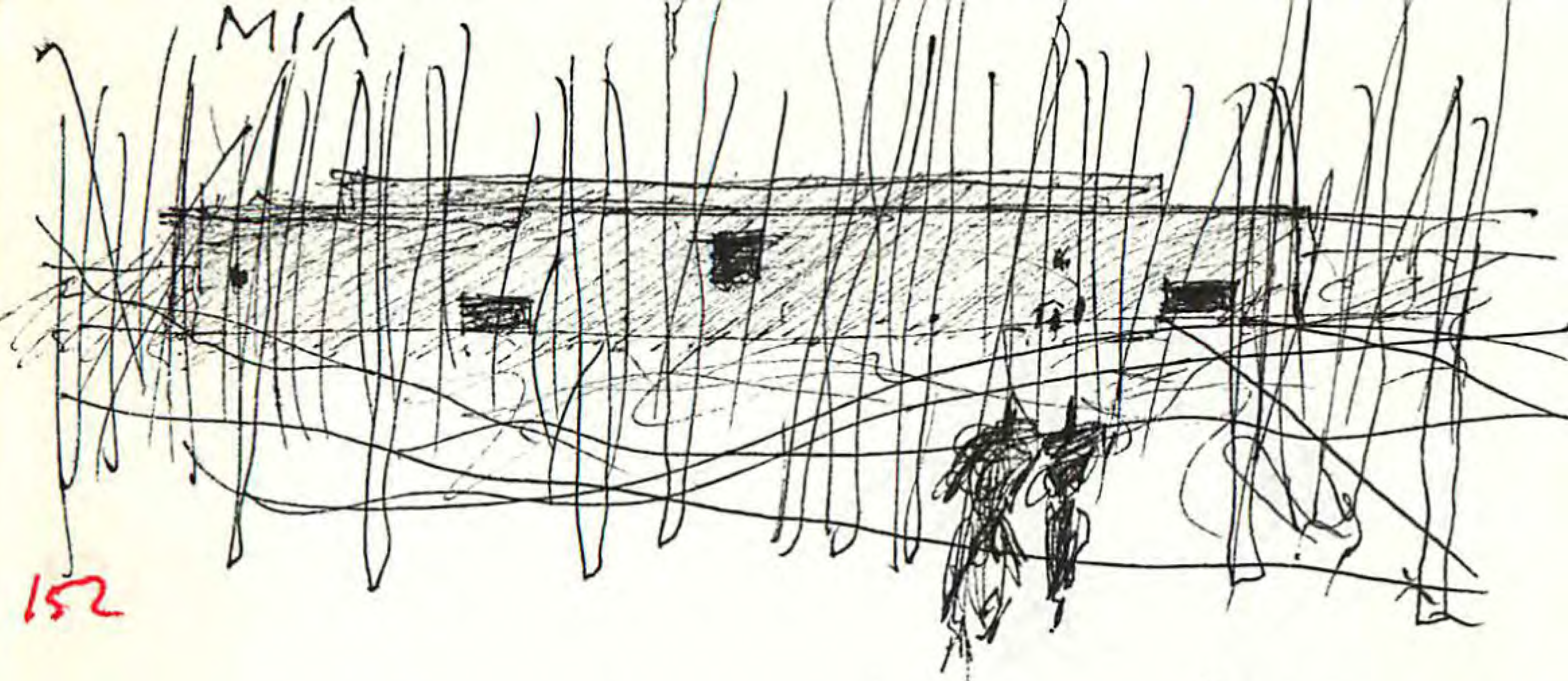

152

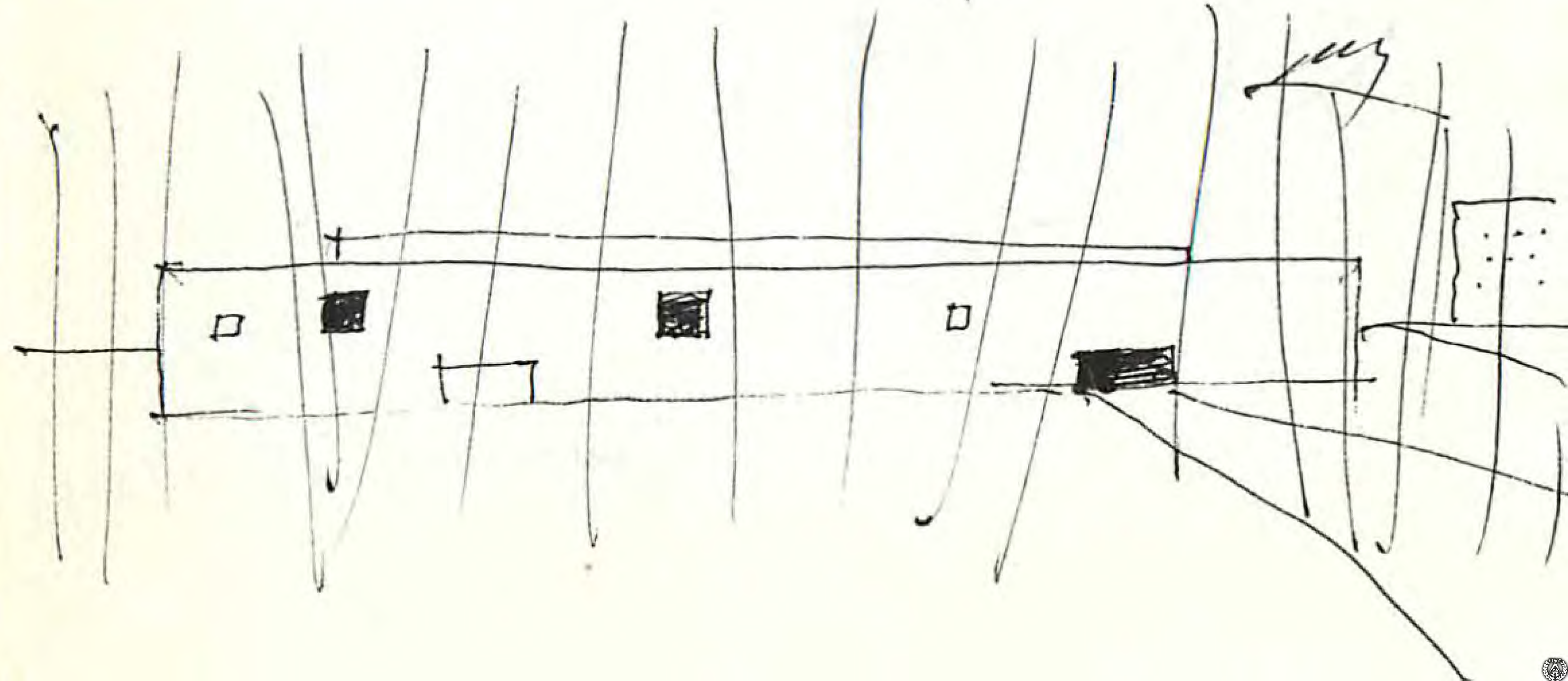



MIA

My

157

31. 2011

Columnar  
Jalundar

101  
111 Rev

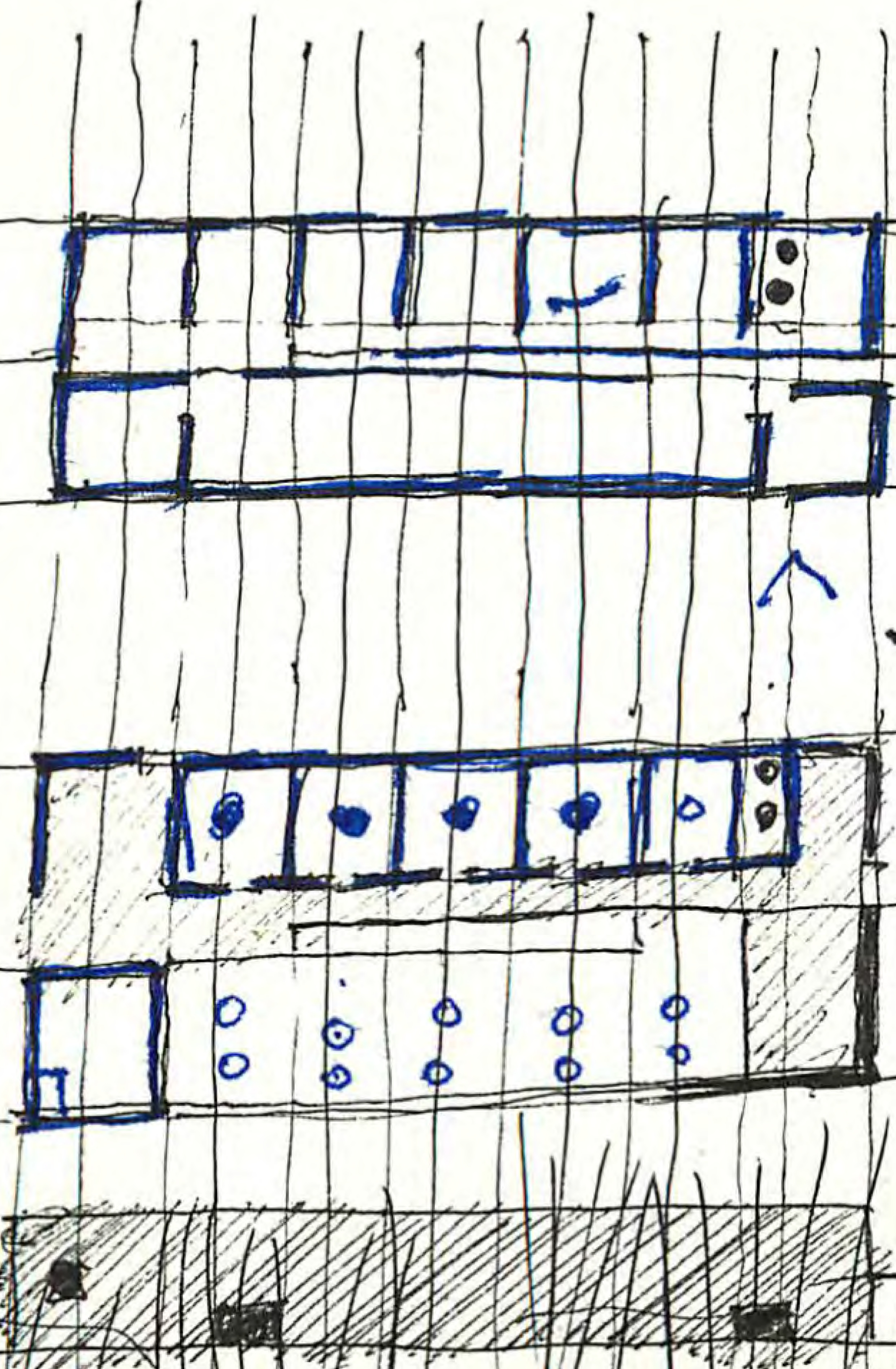

MITA

851

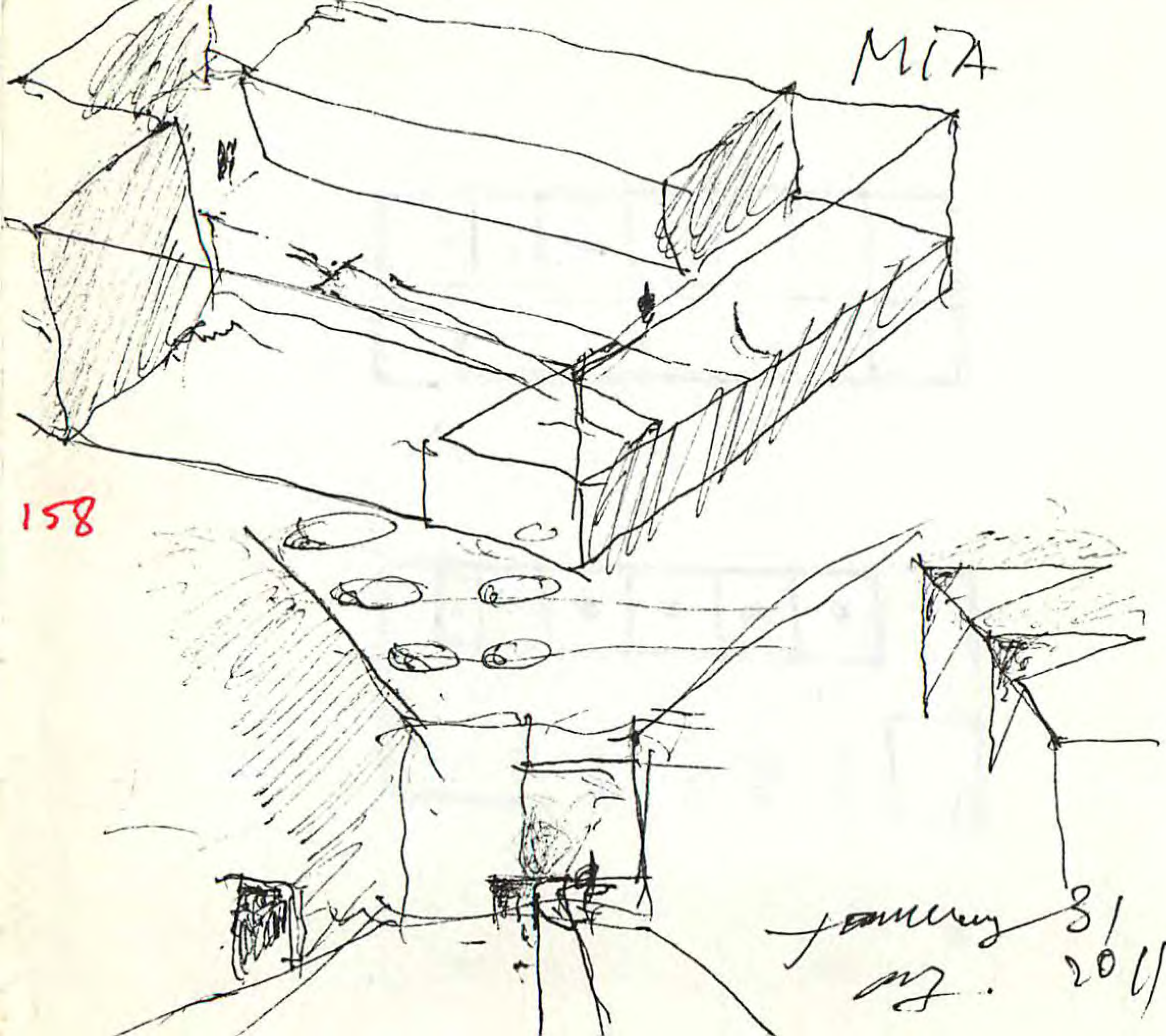

January 8 / 2011  
 For

MIA

N

W

5

159

0  
11

2

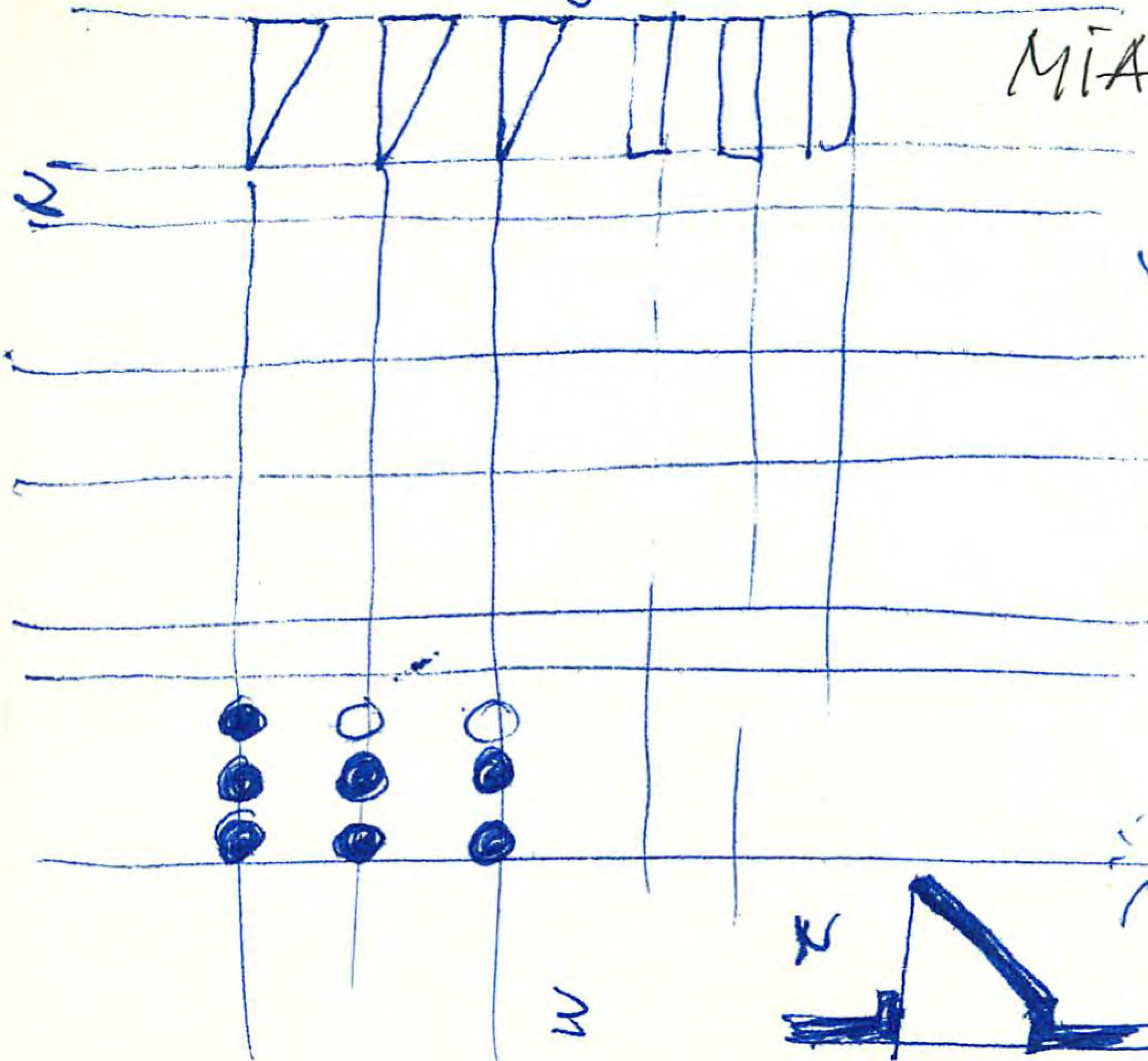

MIA

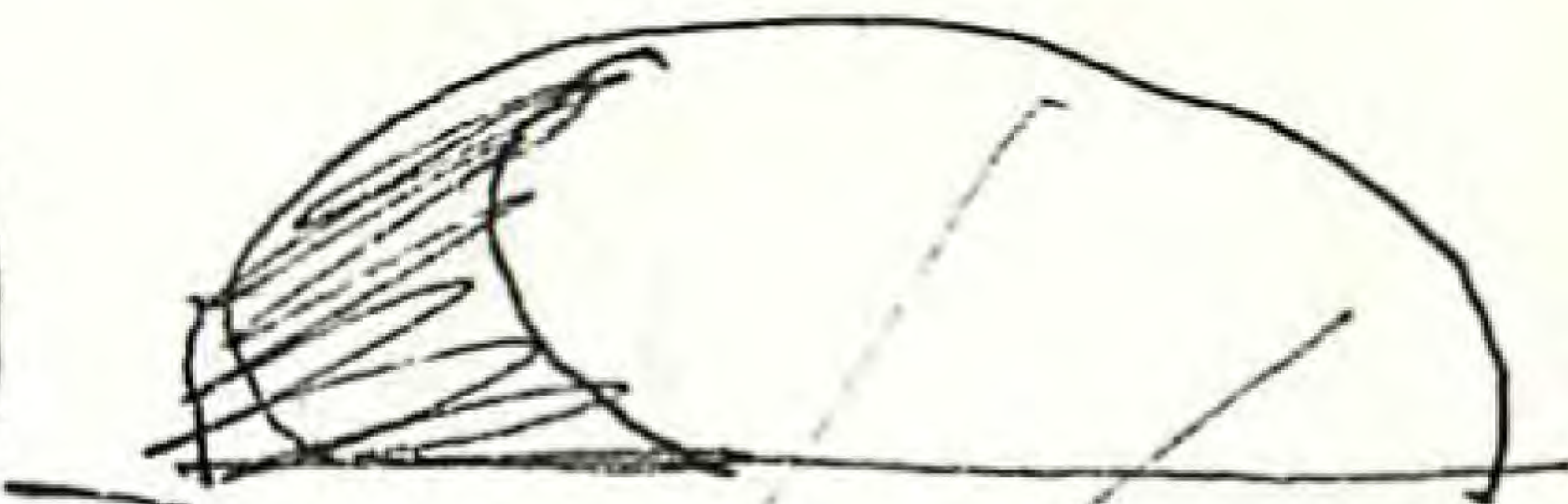
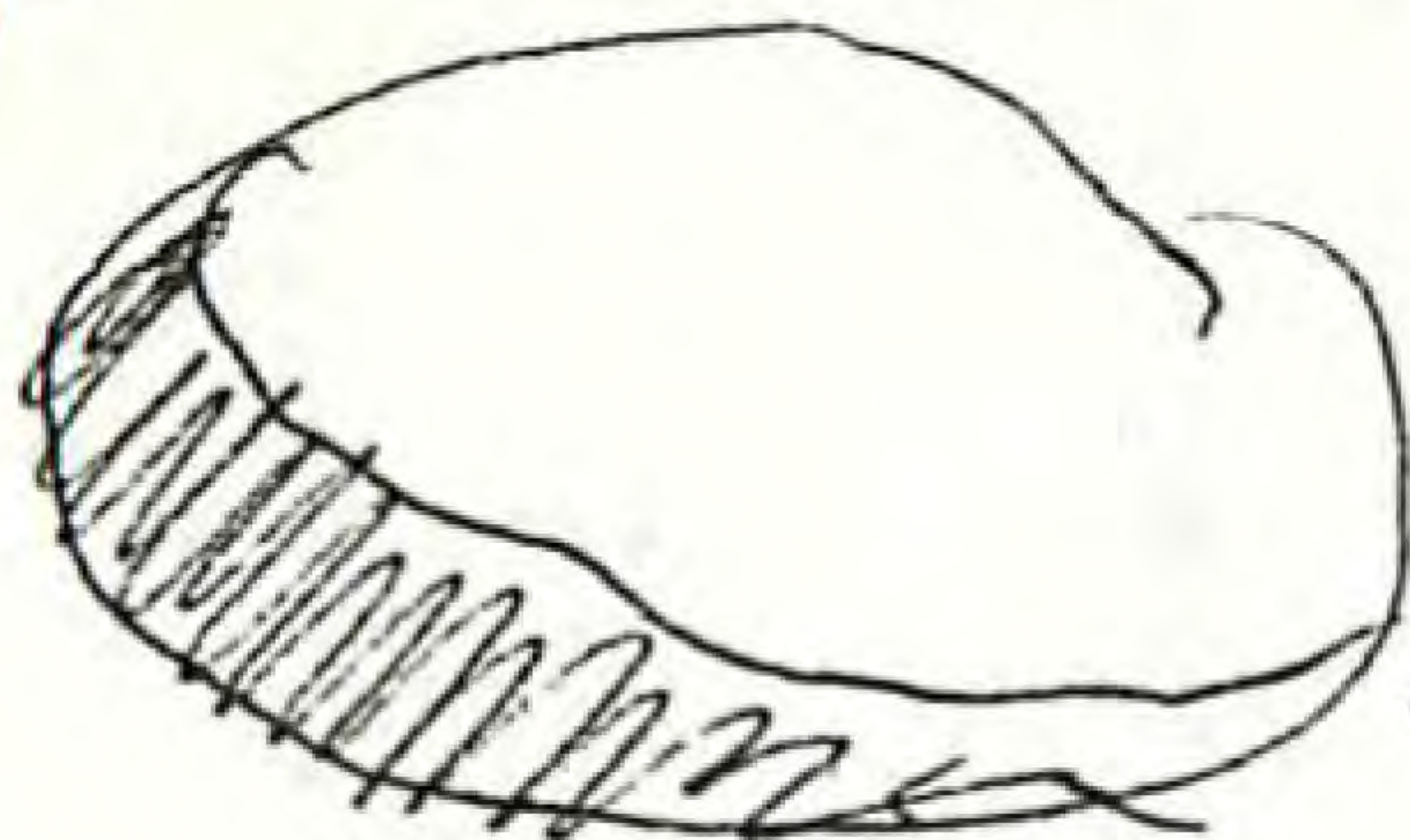
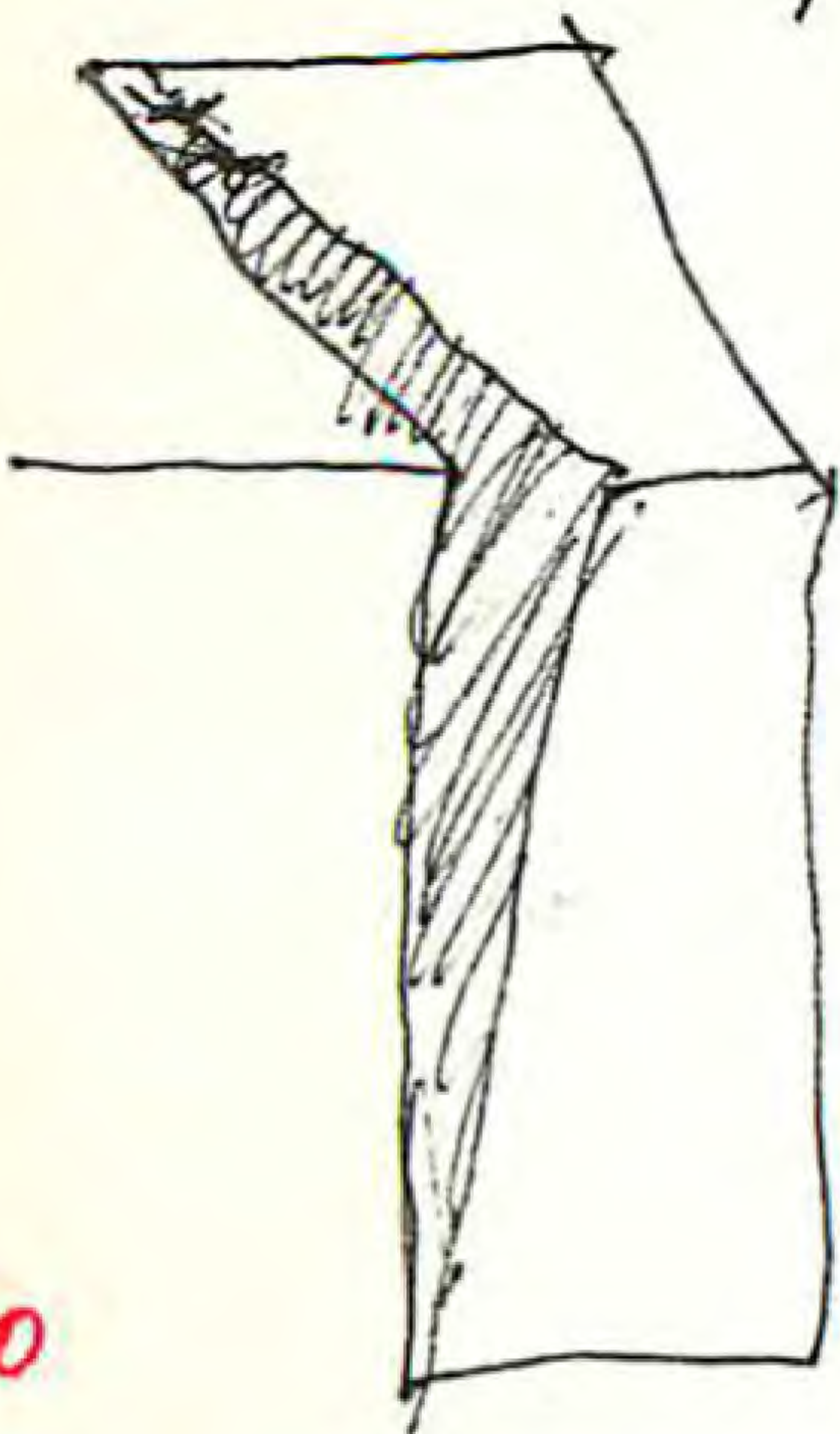

3

2



160

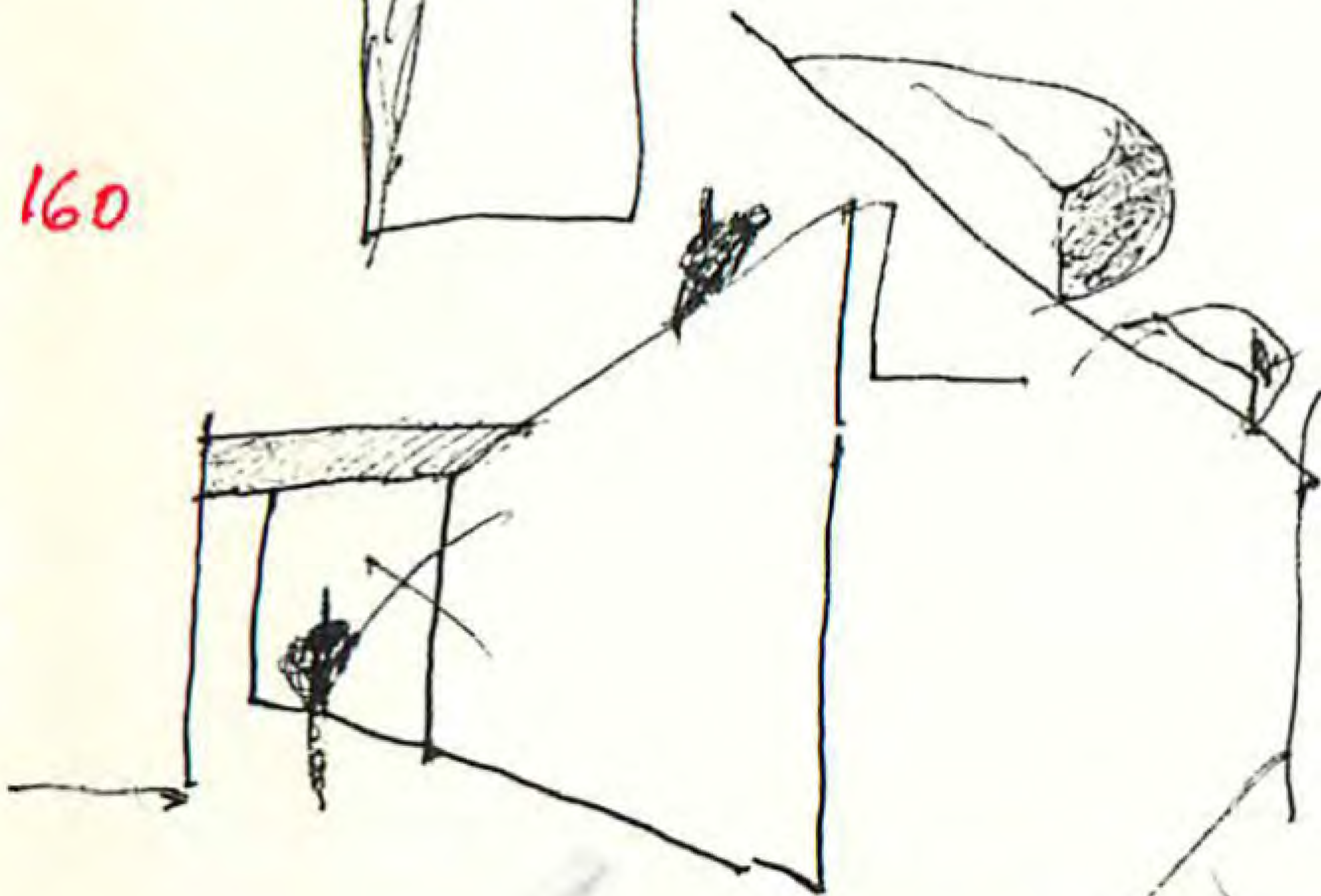

January 31. 2011

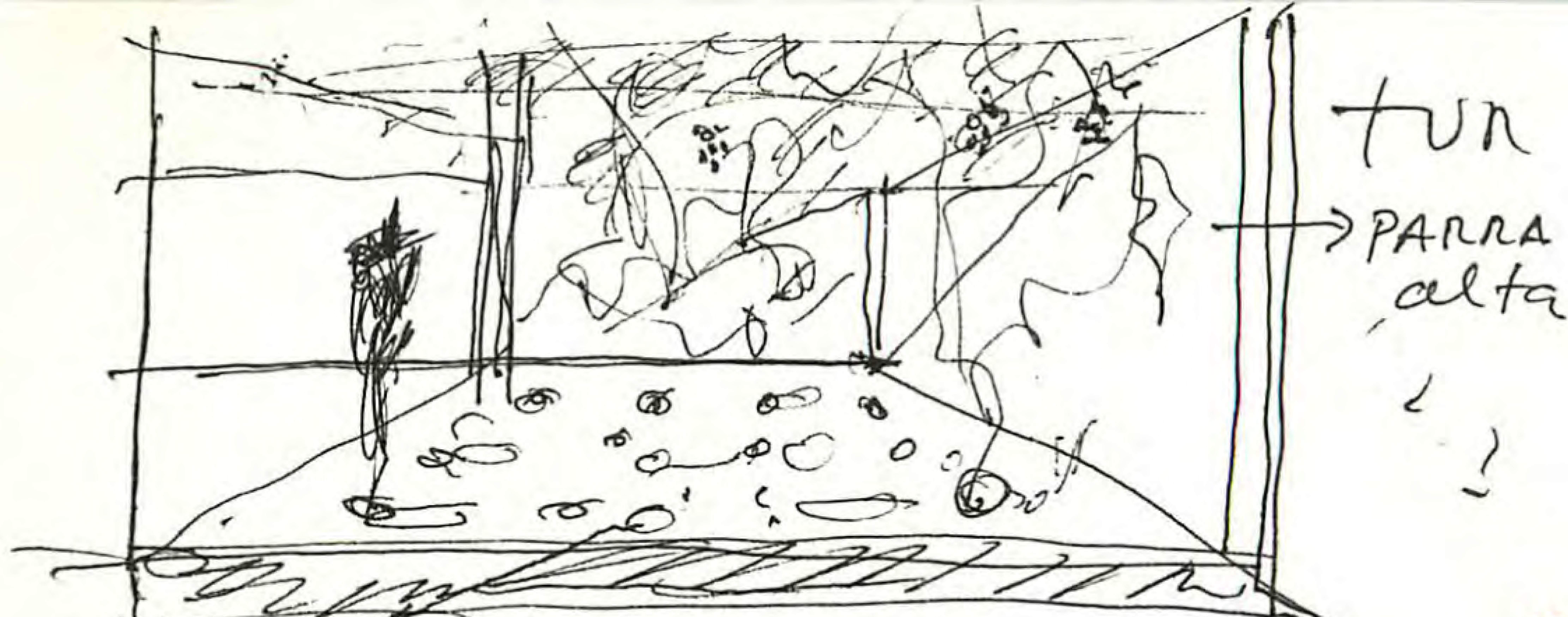

tun  
 → PARRA  
 alta

161

Jan 31. 2011  
 en  
 Columbia

HORTUS HUERTO  
 PETREUS AMENO  
 BOTANICUS

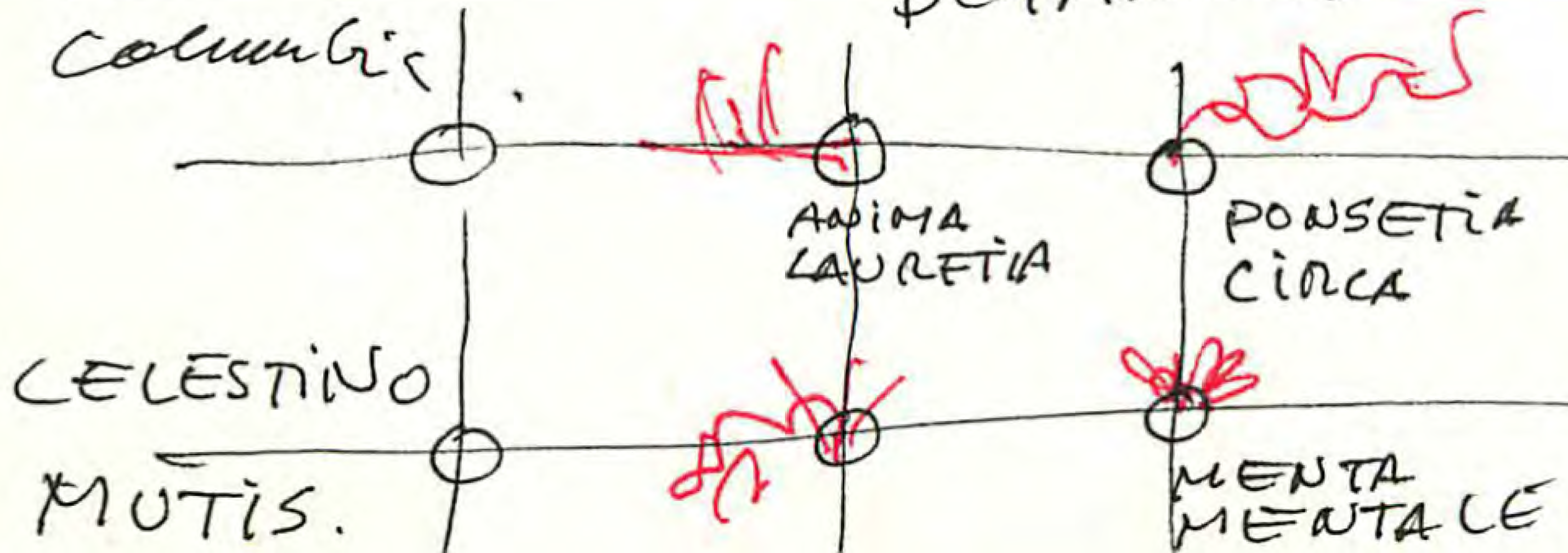

ANIMA  
 LAURETIA

POWSETIA  
 CIRCA

MENTA  
 MENTALE

CELESTINO  
 MUTIS.

MIA

162

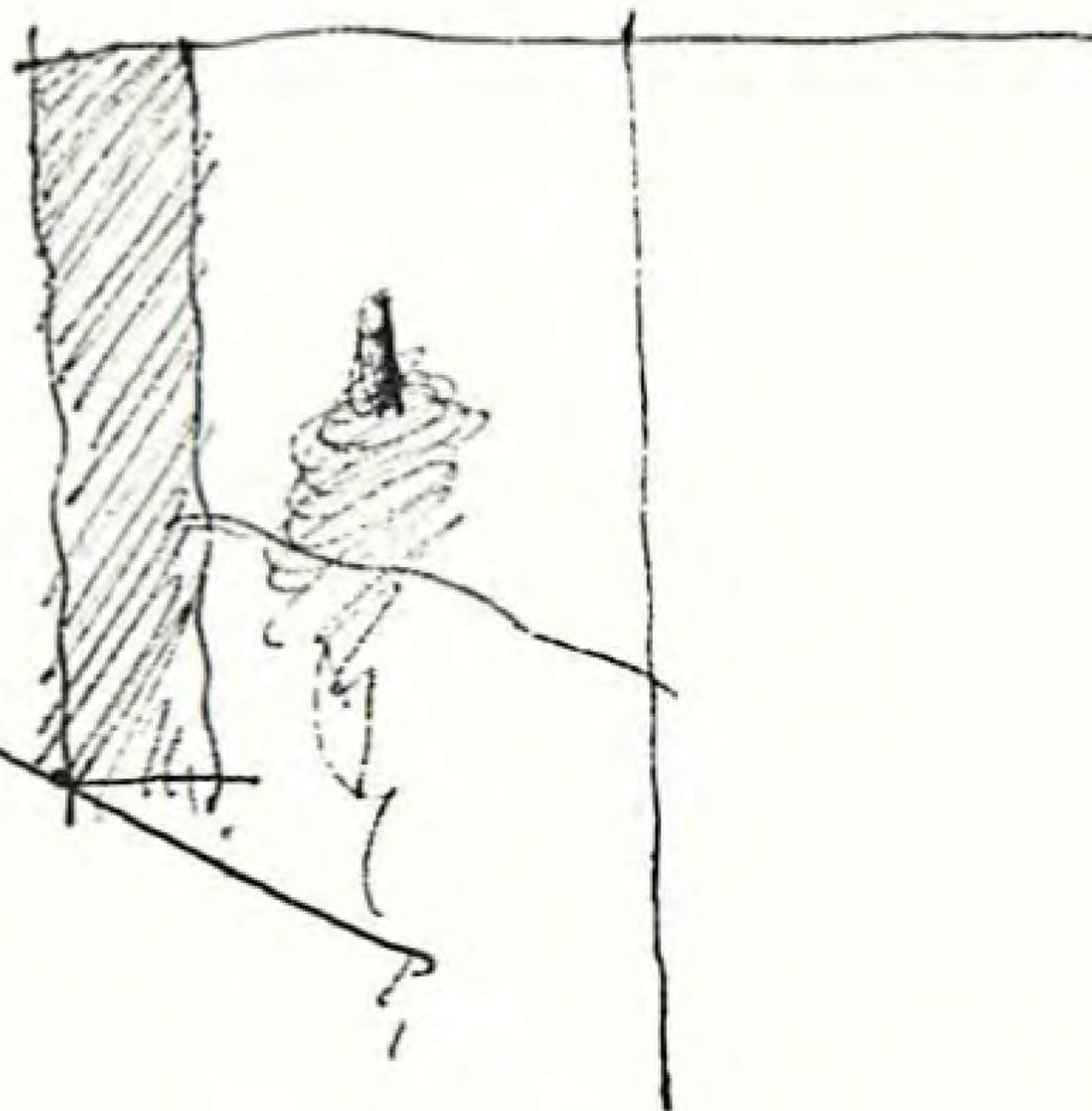

*[Handwritten signature]*

January 31. 1911

Avery Library, N.Y. Columbia U.

MIA

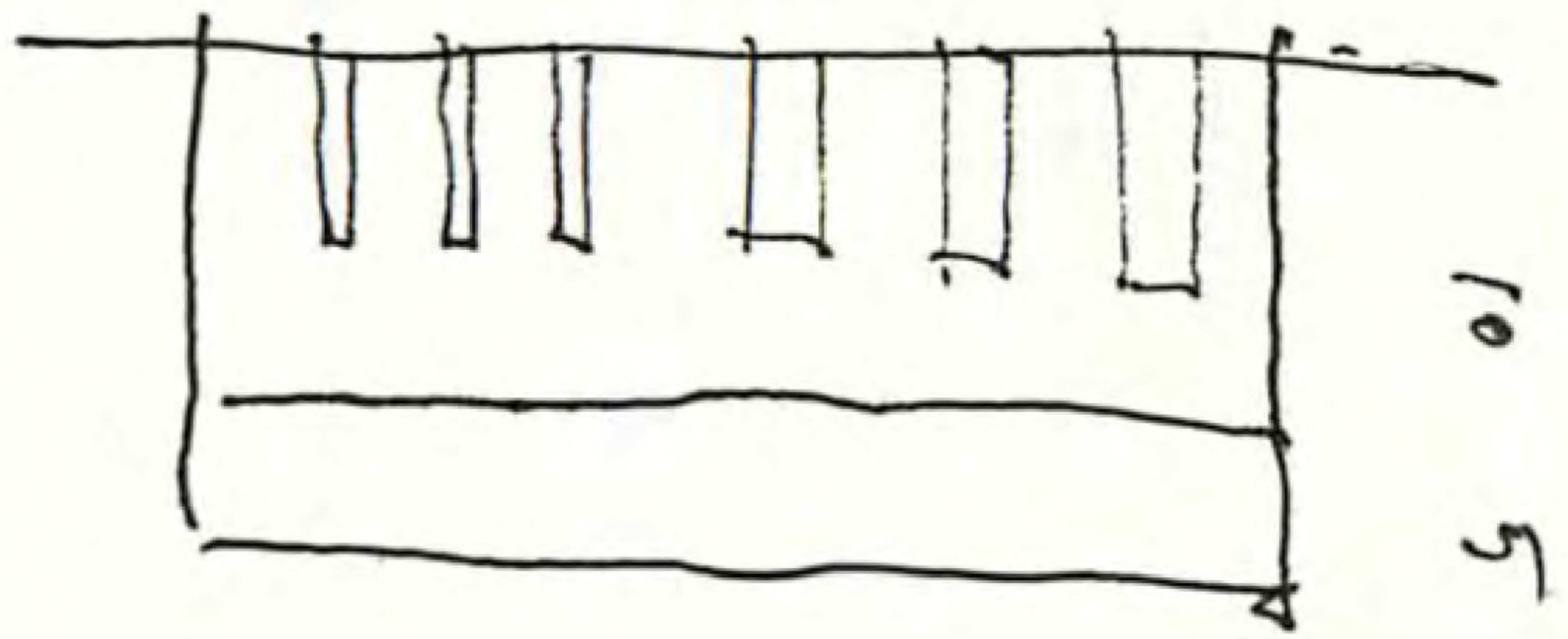
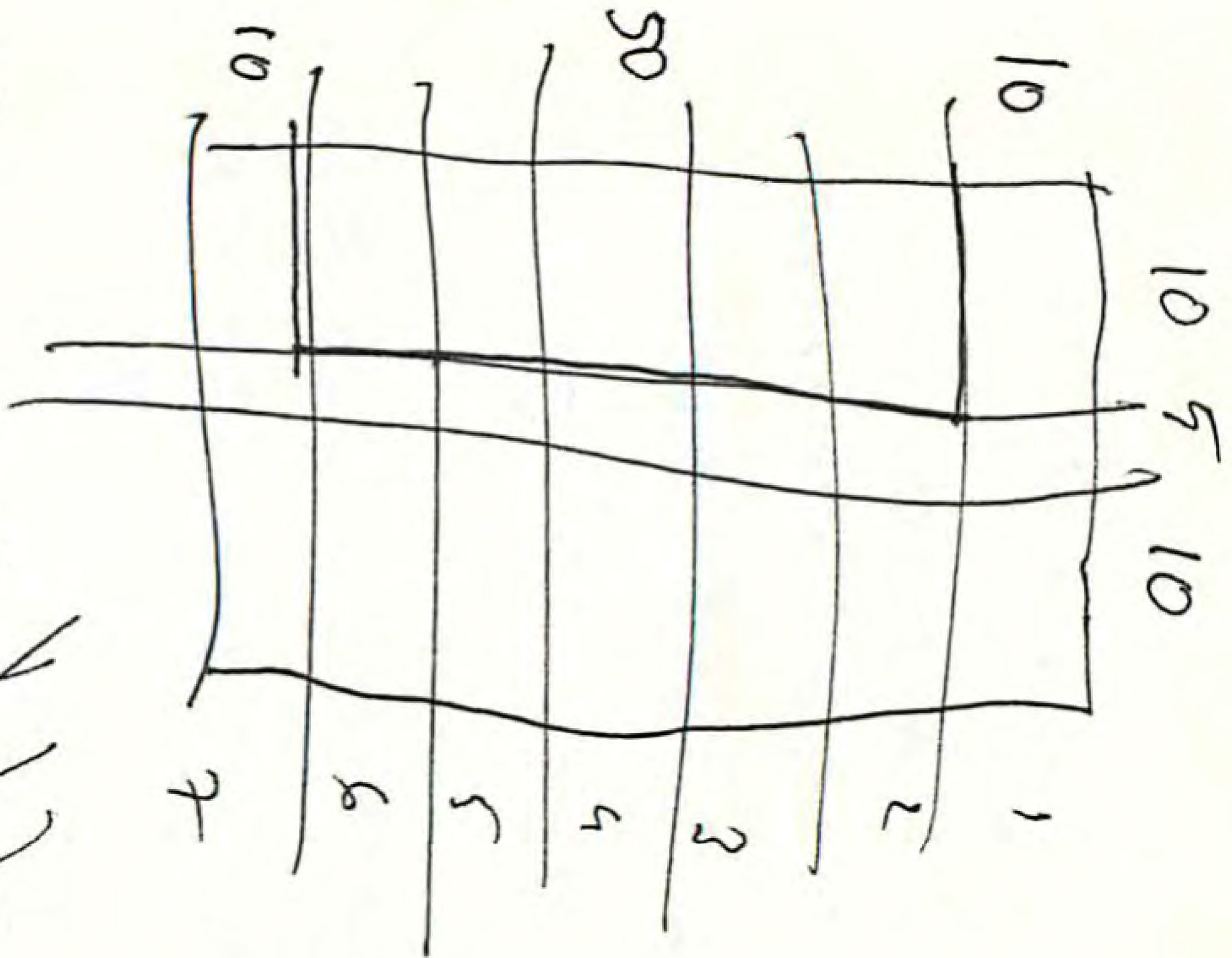
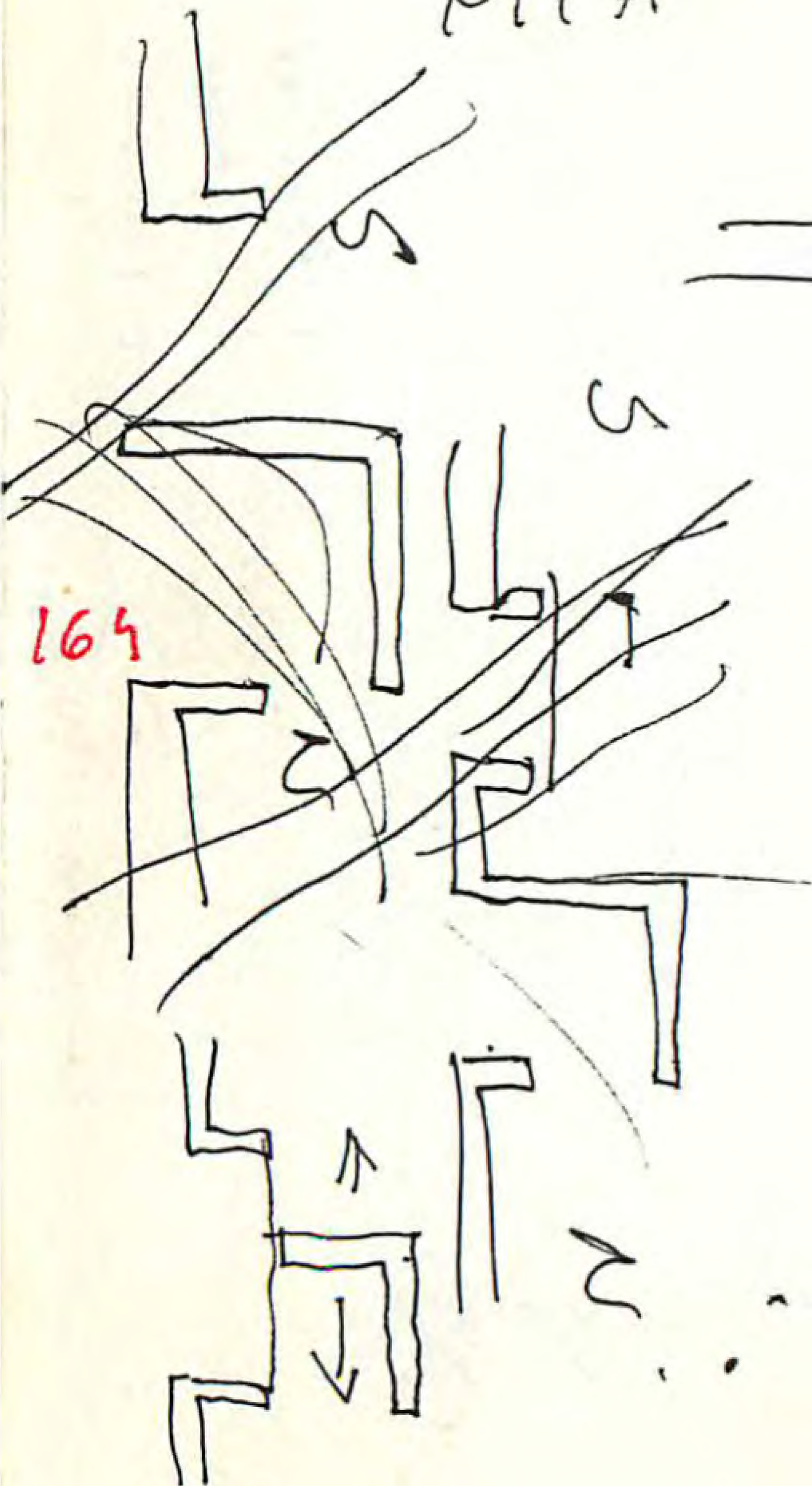

MIA

February  
January 3. 2011

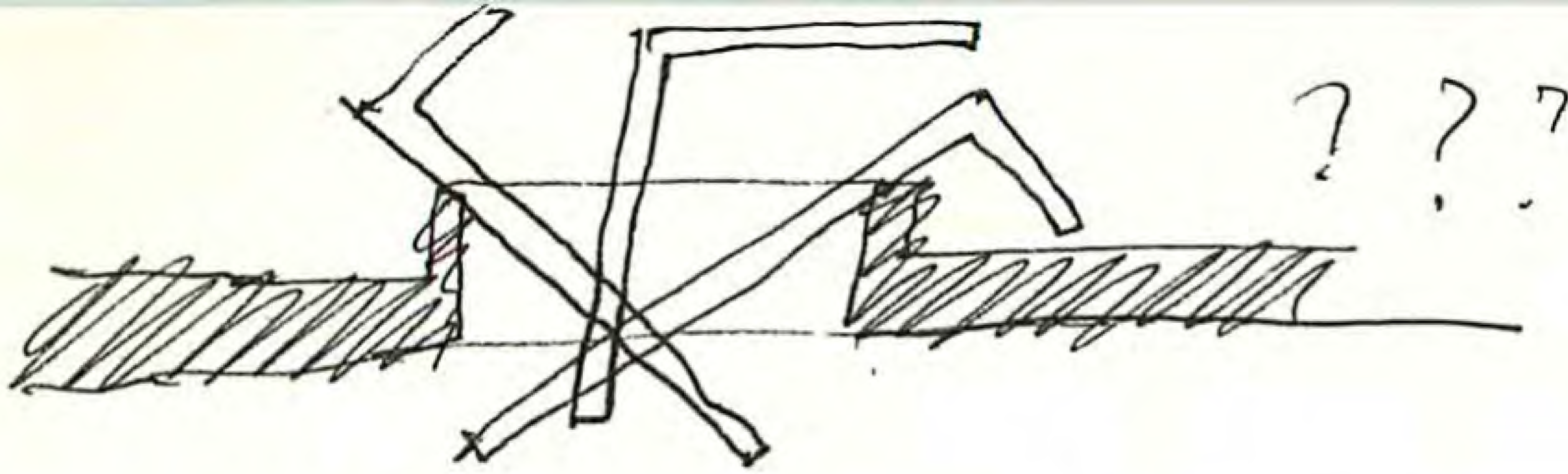

MIA

to create a design for light  
incent

simple  
cheap.  
obvious.

165

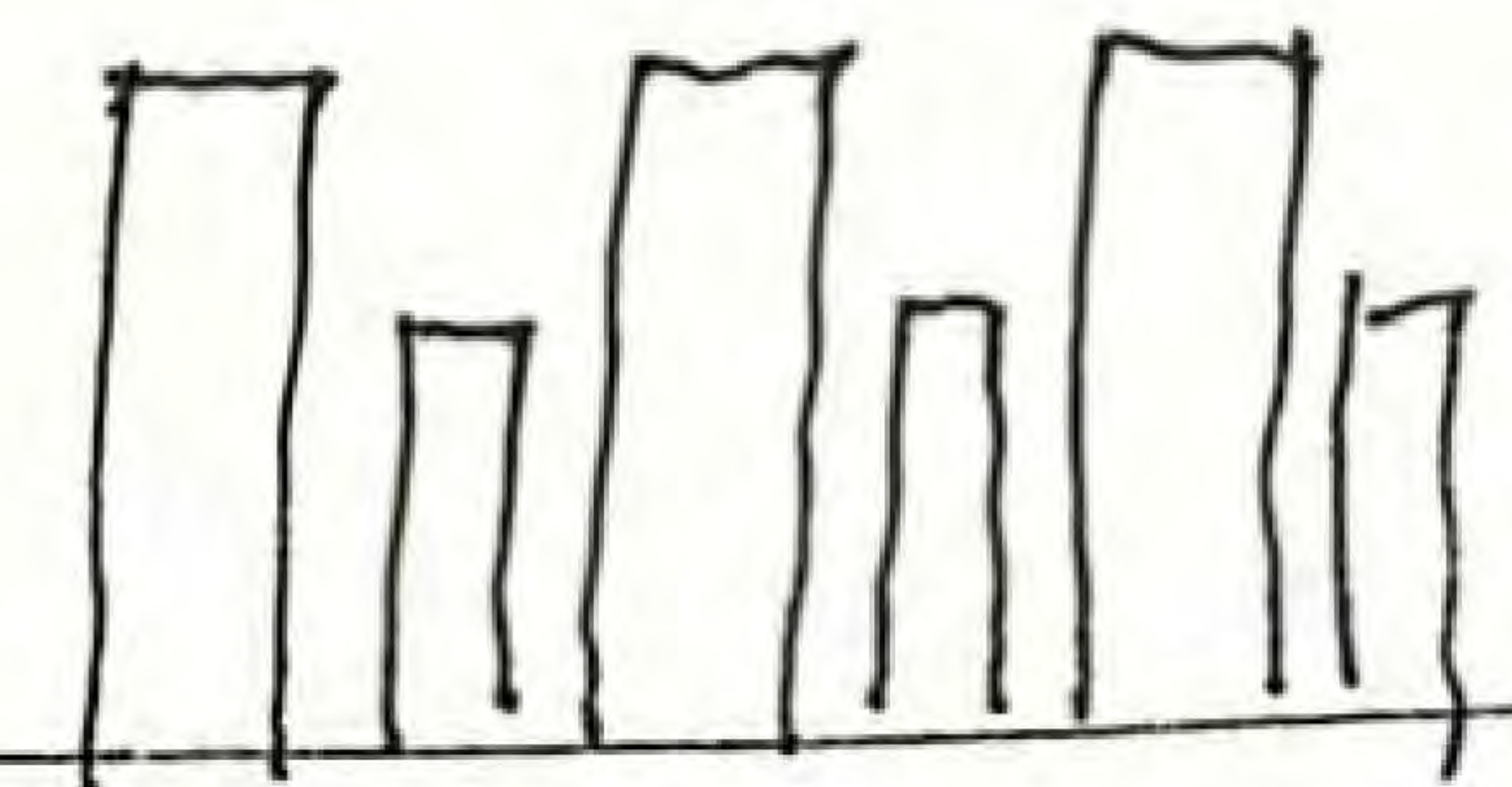

it  
looks like a piano

① it is Friday February 4  
I am in garrison (village) with Miguel.  
It is 10:30 am. Sunny day. Snow. Happy.  
after a coffee, a glass of water.



MIA

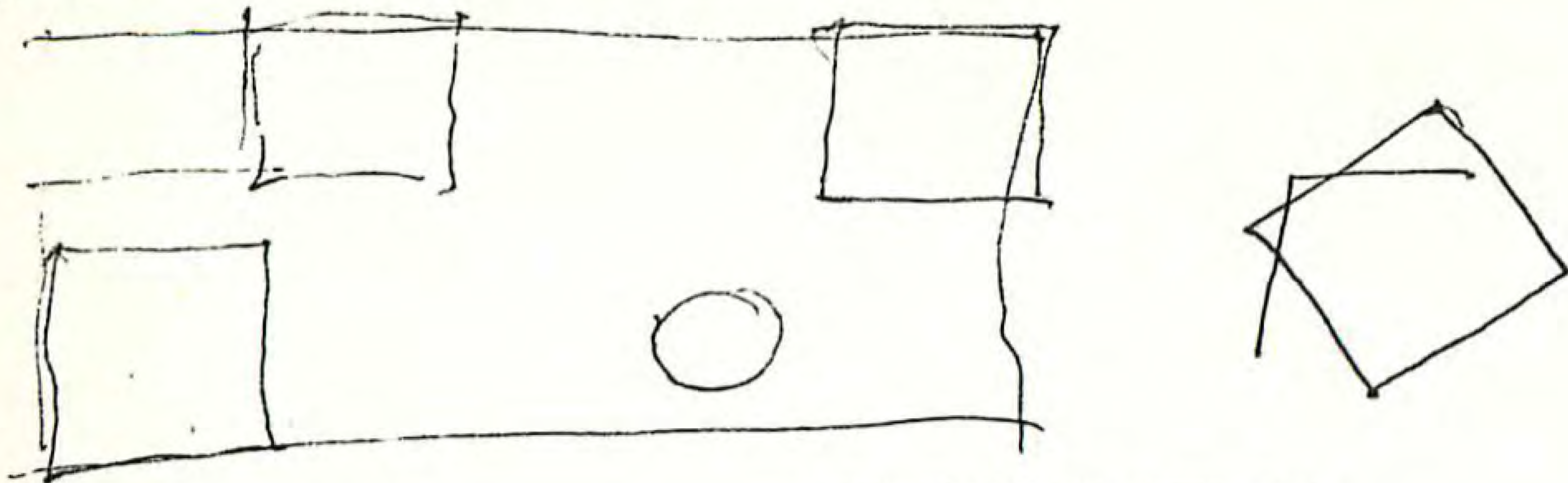

166

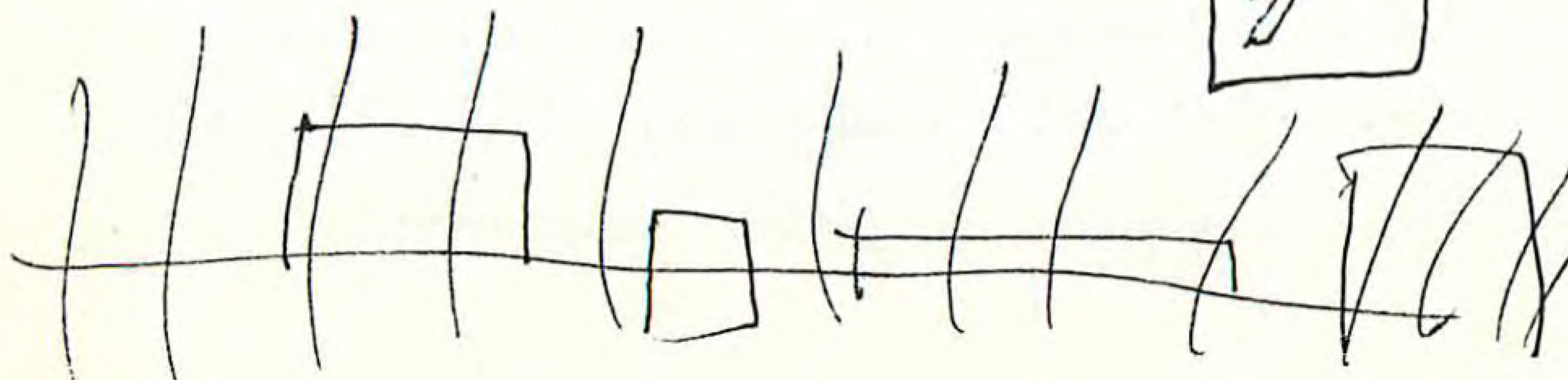
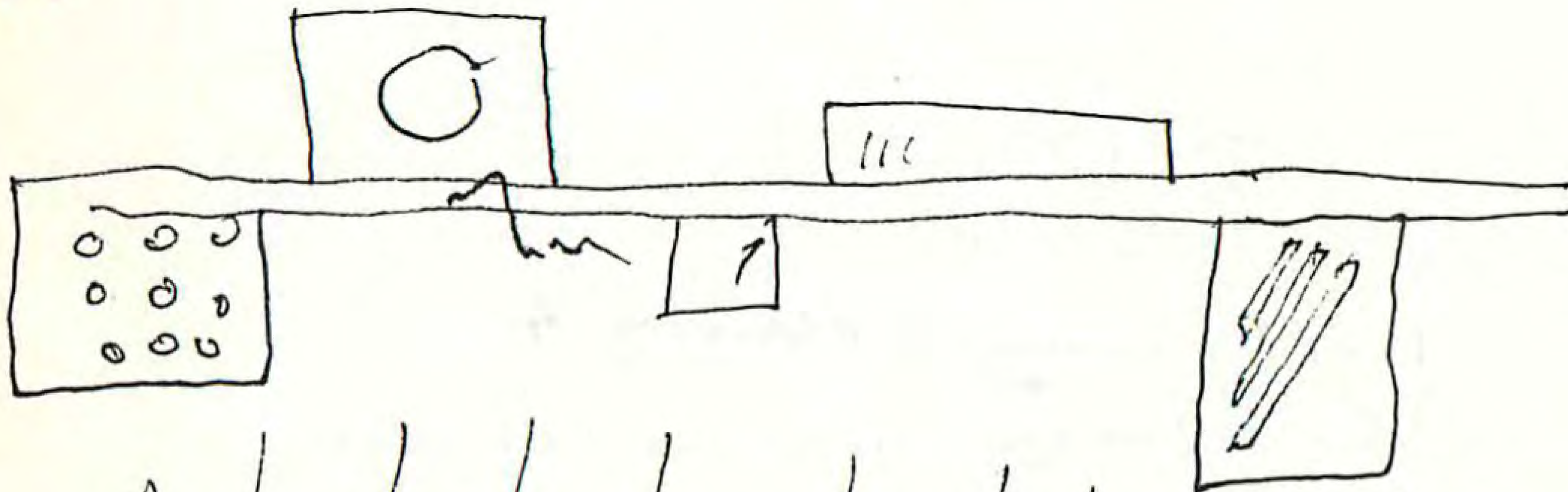

MIA

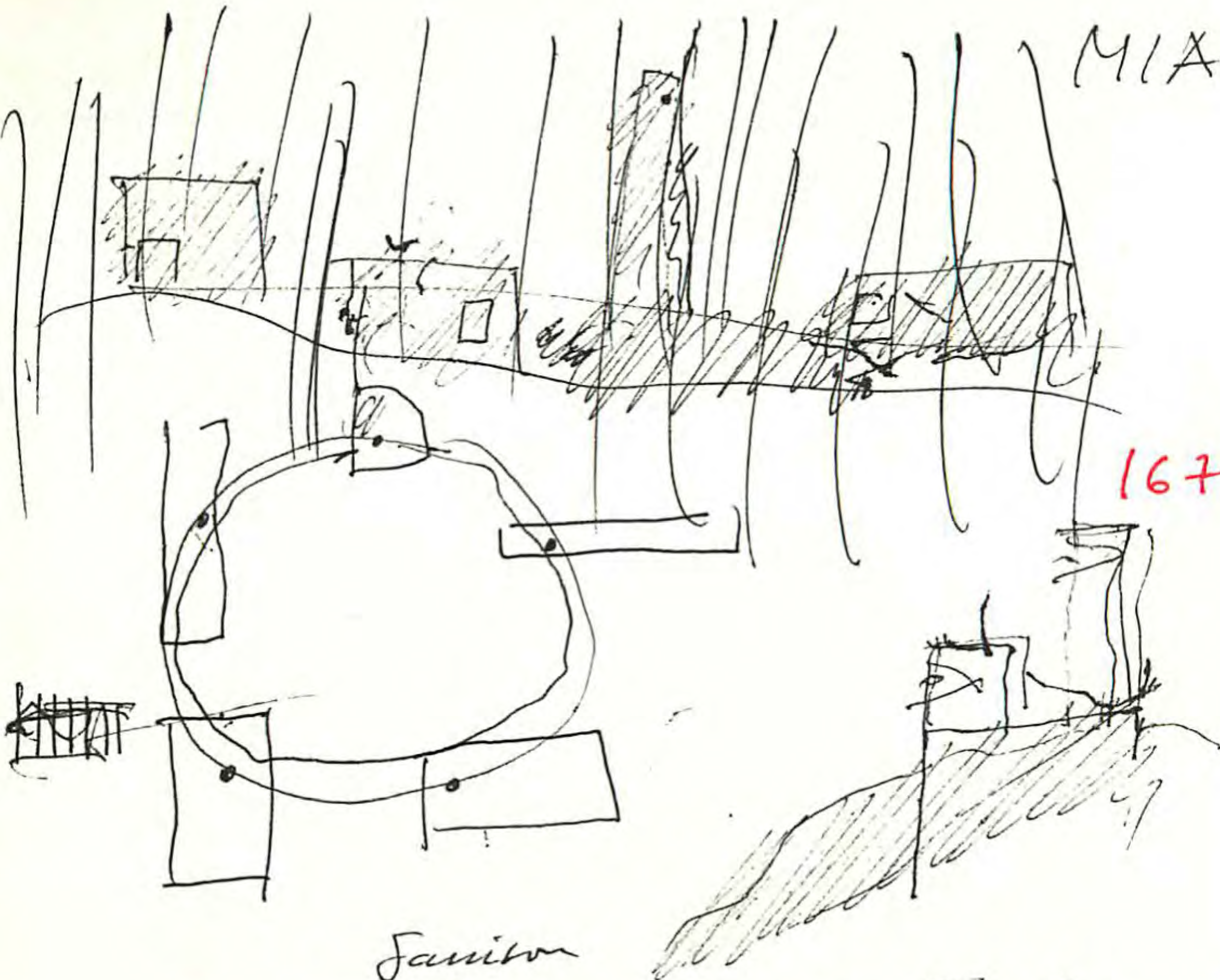

167

Jamison  
February 4, 2011 in Jamison

MIA

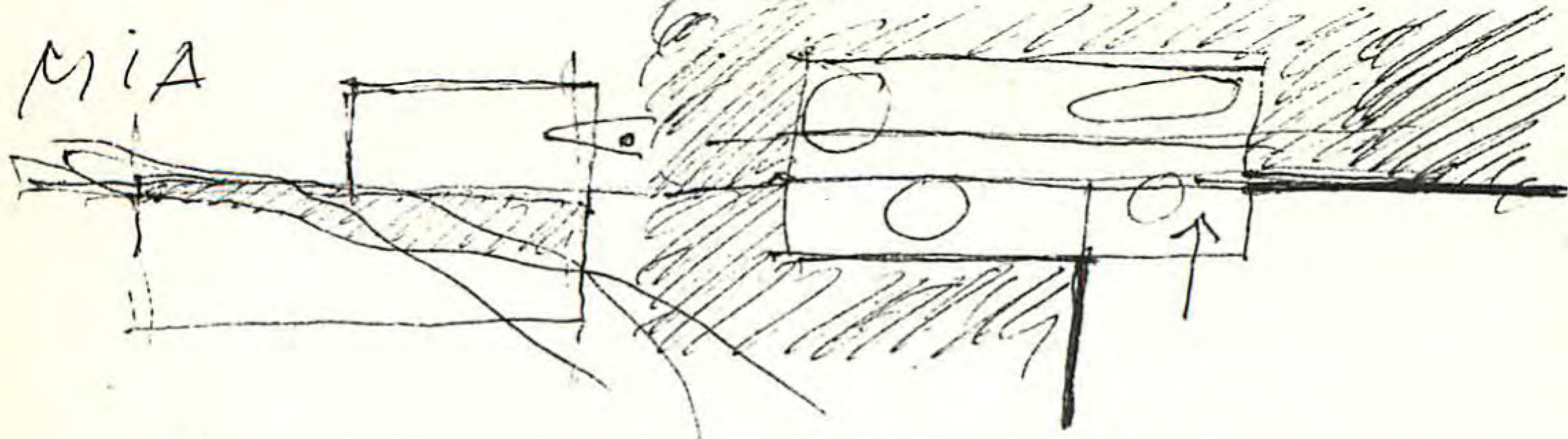

168

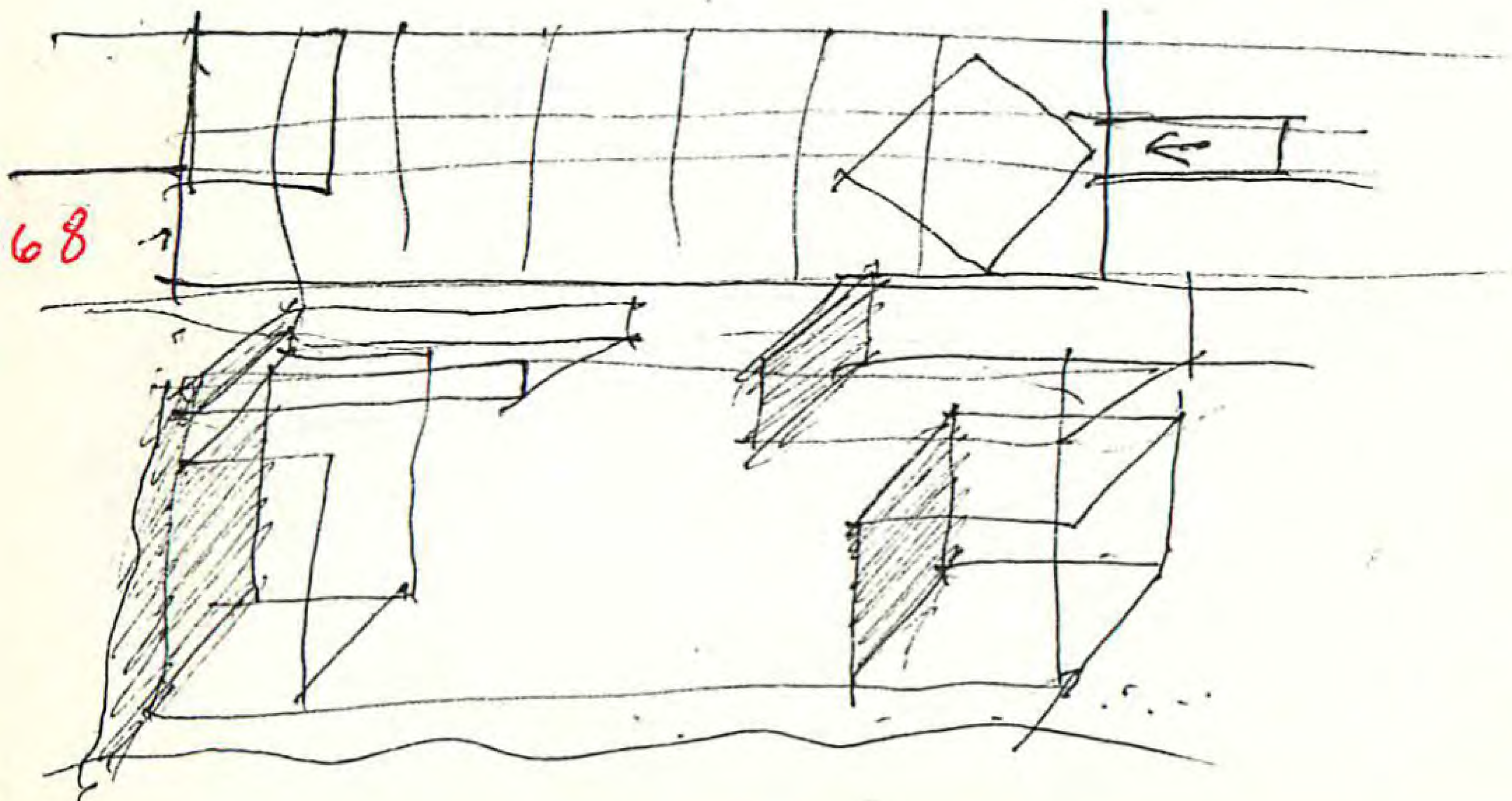

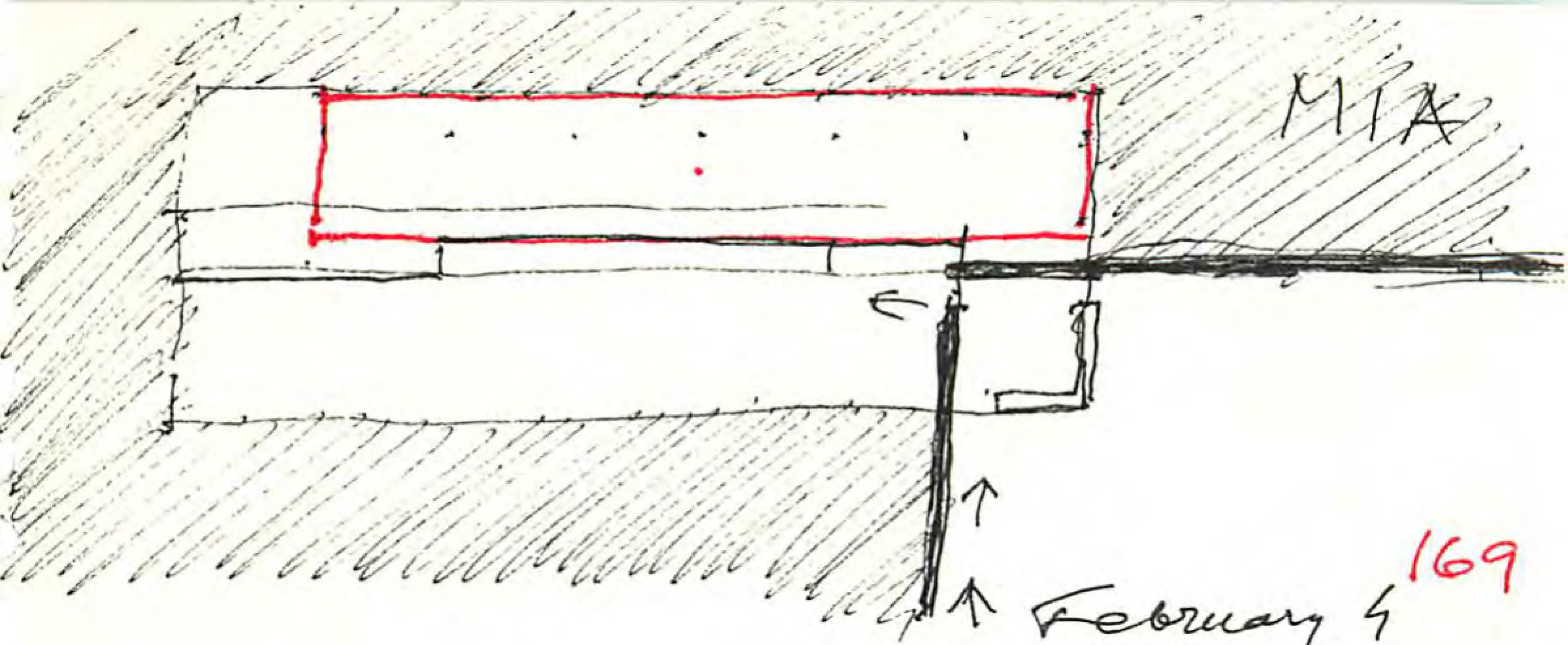

MTA

February 4<sup>169</sup>  
2011

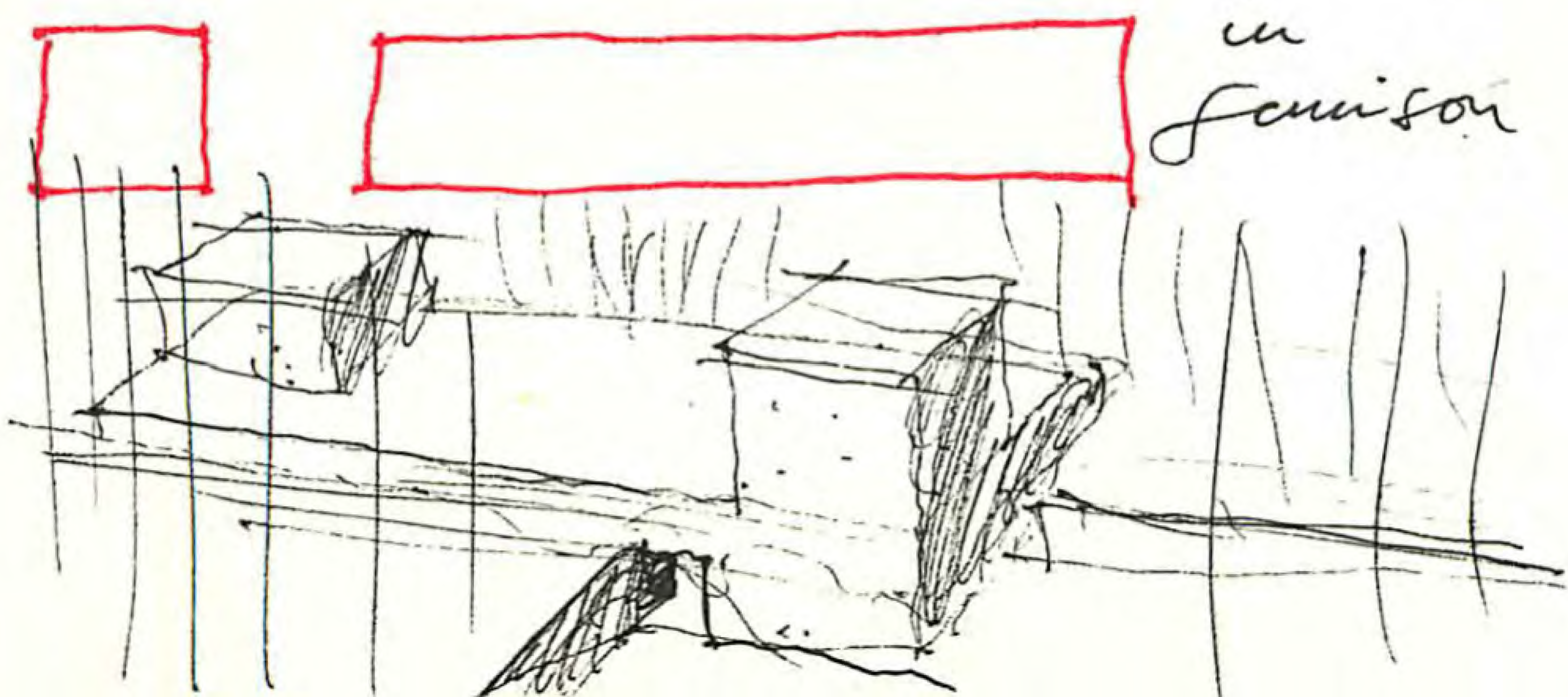

in  
Fenison

MIA

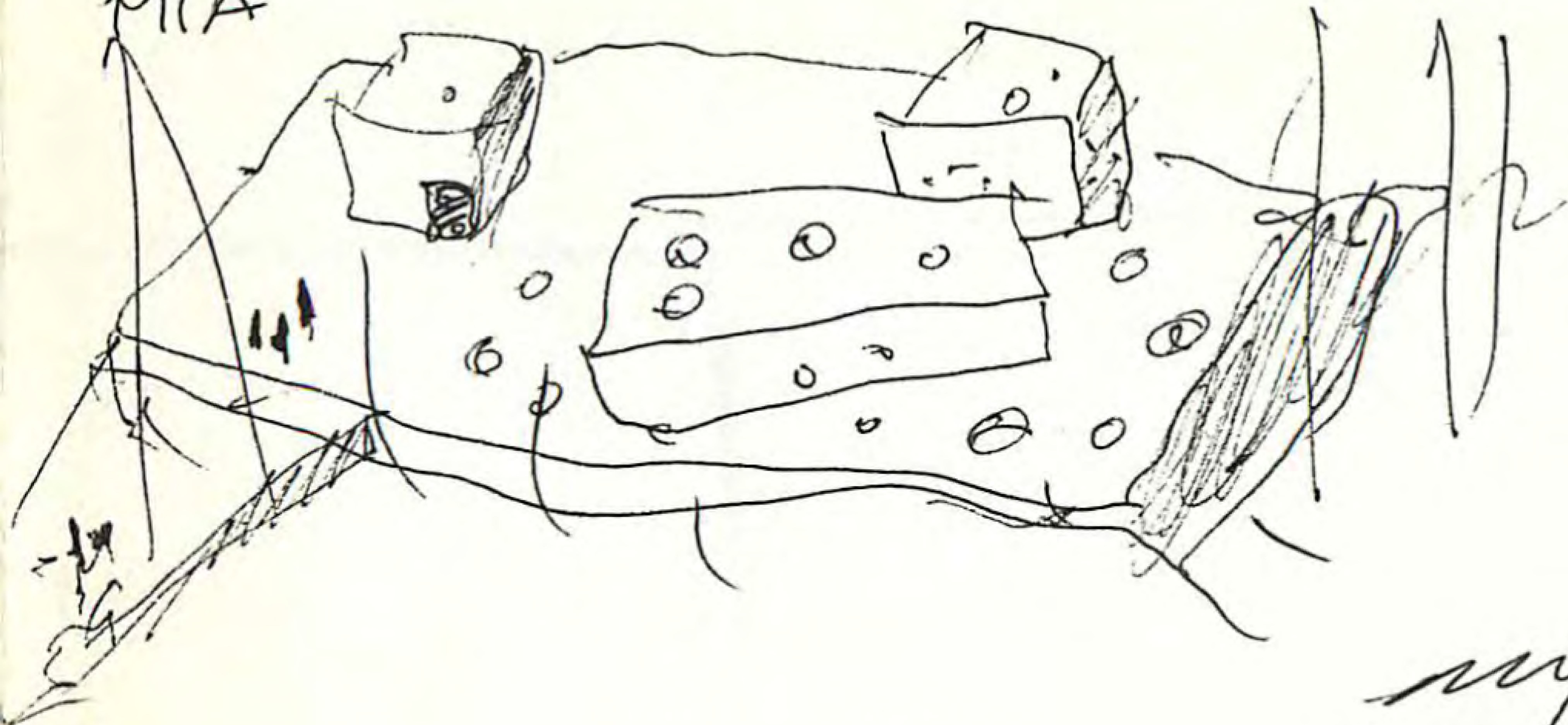

170

my

Garrison

February 4 . 2011

with Miguel .