

Nov 2006

X

P19  
1



GVA

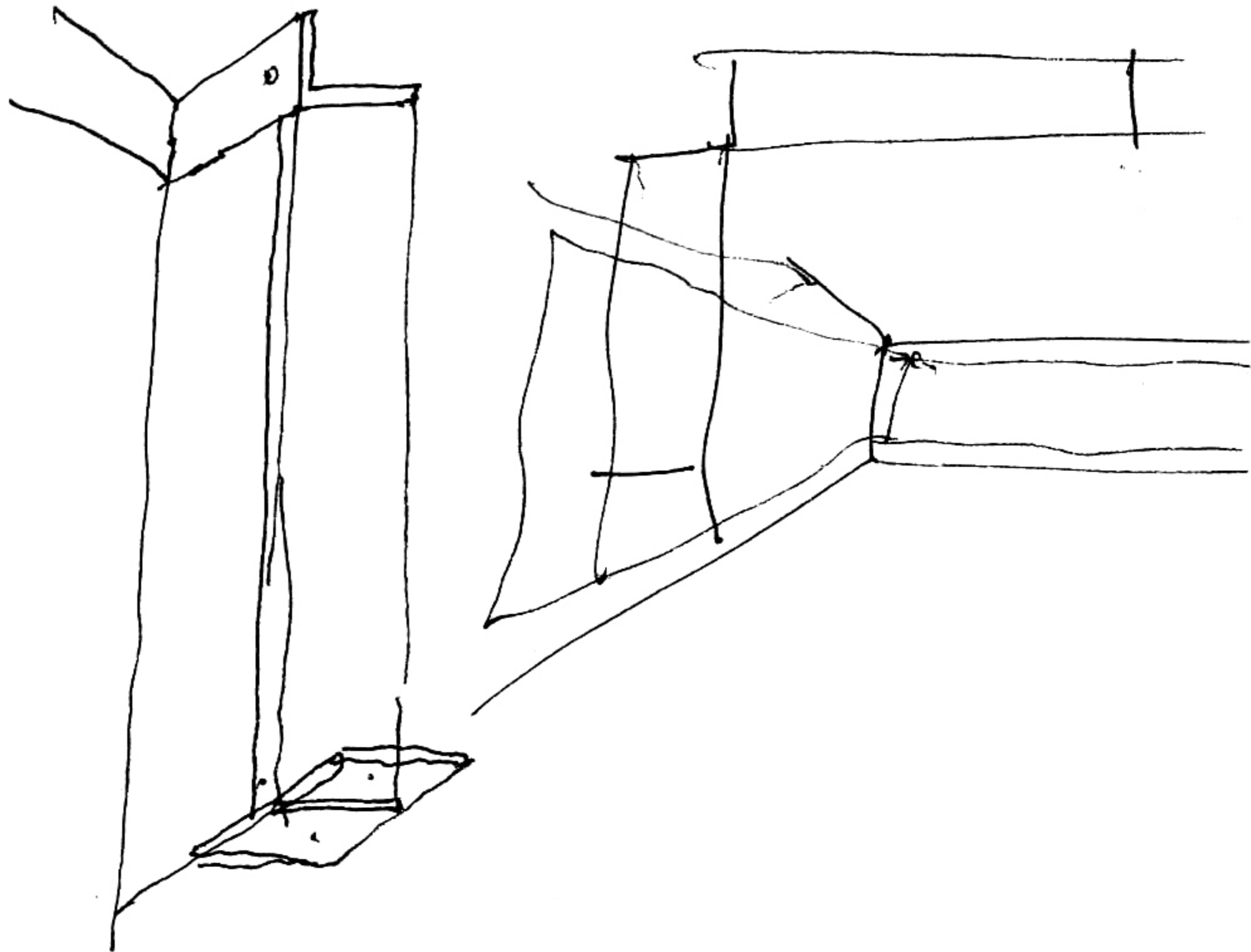

LESS IS MORE  
QVIO NIHIŁ NISI MINUS



o bden

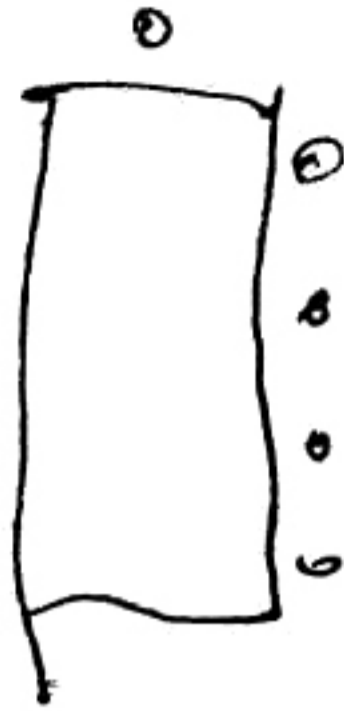

eu colorz.



+

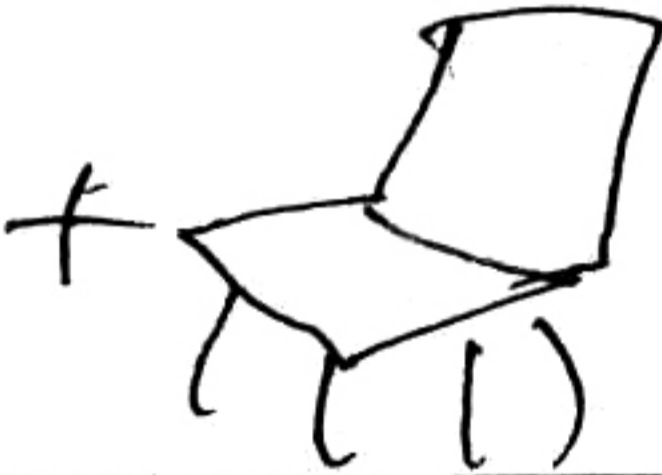

+

familia Blasco

RUNE. CCAE710a KOI NTTO

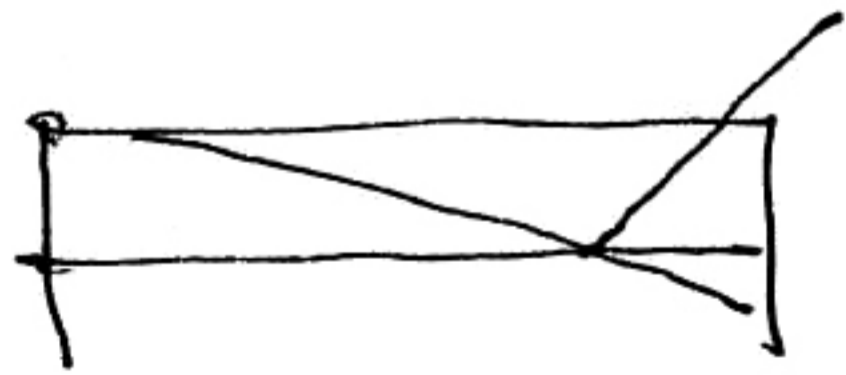

la OZNick  
la SPANU.

or

+ lamp.

+ scumbora

+ butucay

# OLMICK SPANU HOUSE

11/ after BOFFI (Duna).

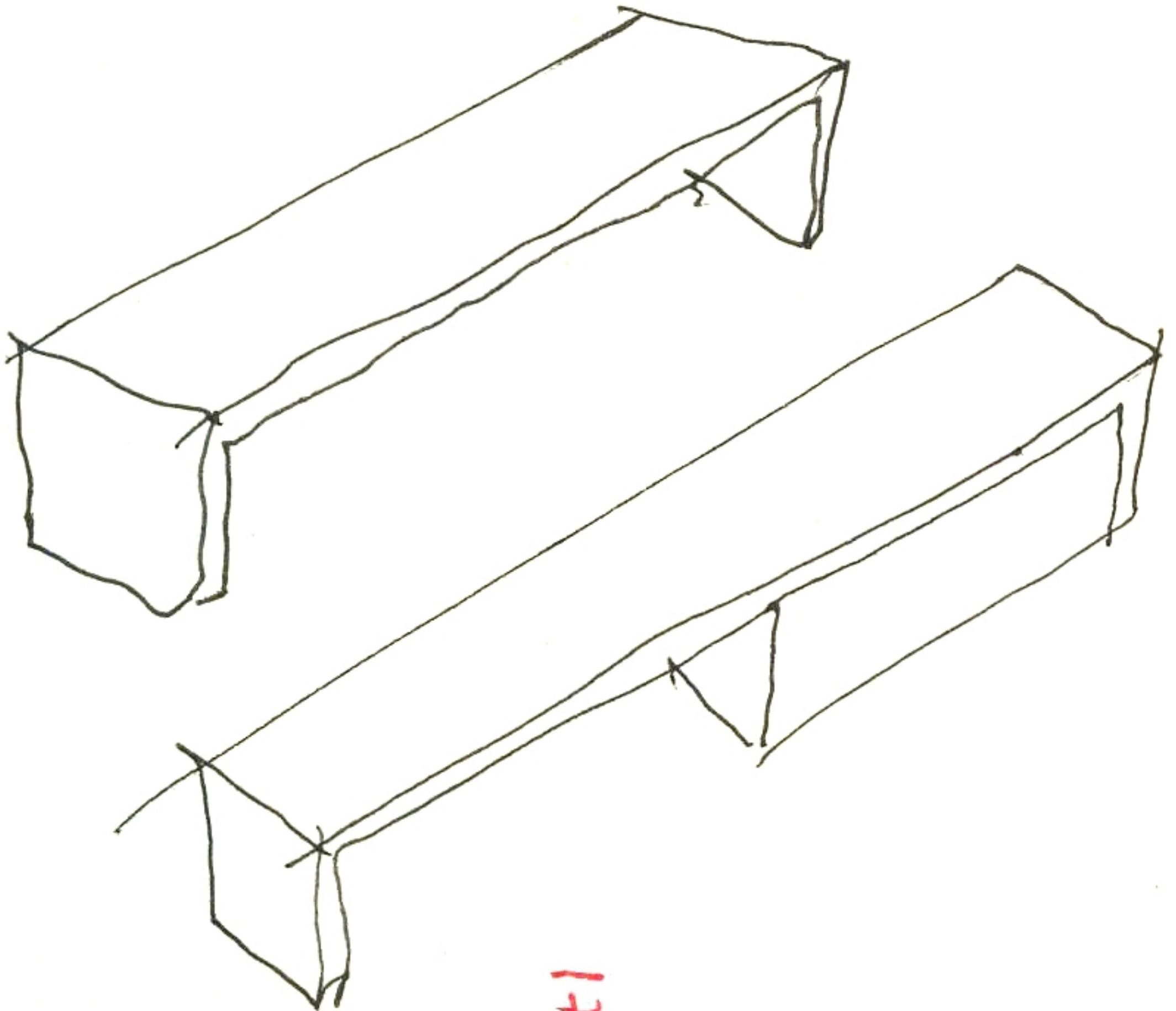
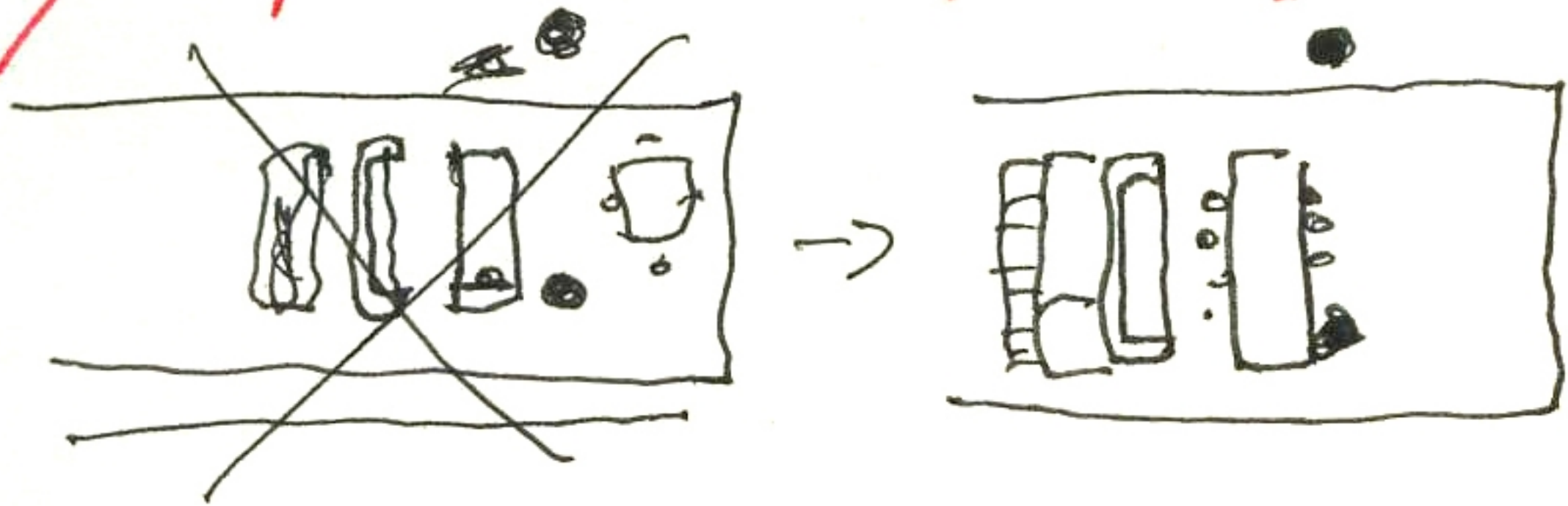

t1

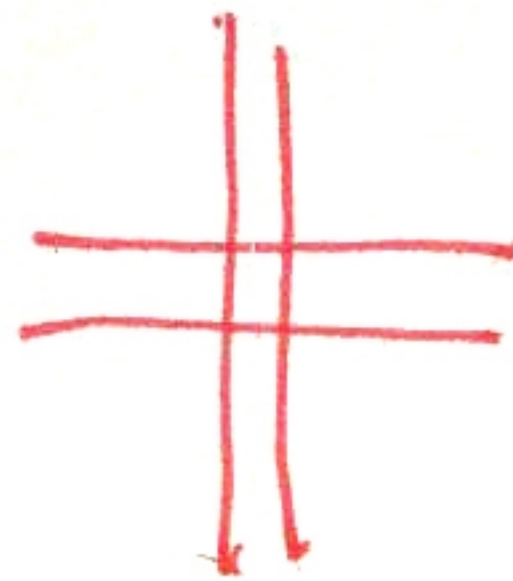

tela  
con frenia

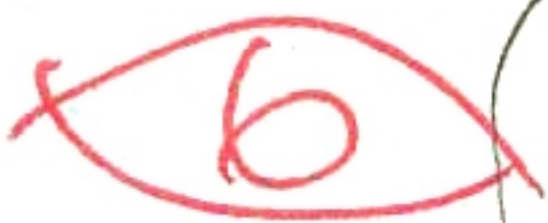

Mon 13. Nov 2008 <sup>1</sup>  
in GARRISON.

at 845 en obert

1)



~~blintel?~~

→ stone

h'0

2)

Counter



0

h'

6)  inventar  
un HAWDRAIL  
de suita y por  
(pensar)

o

7)

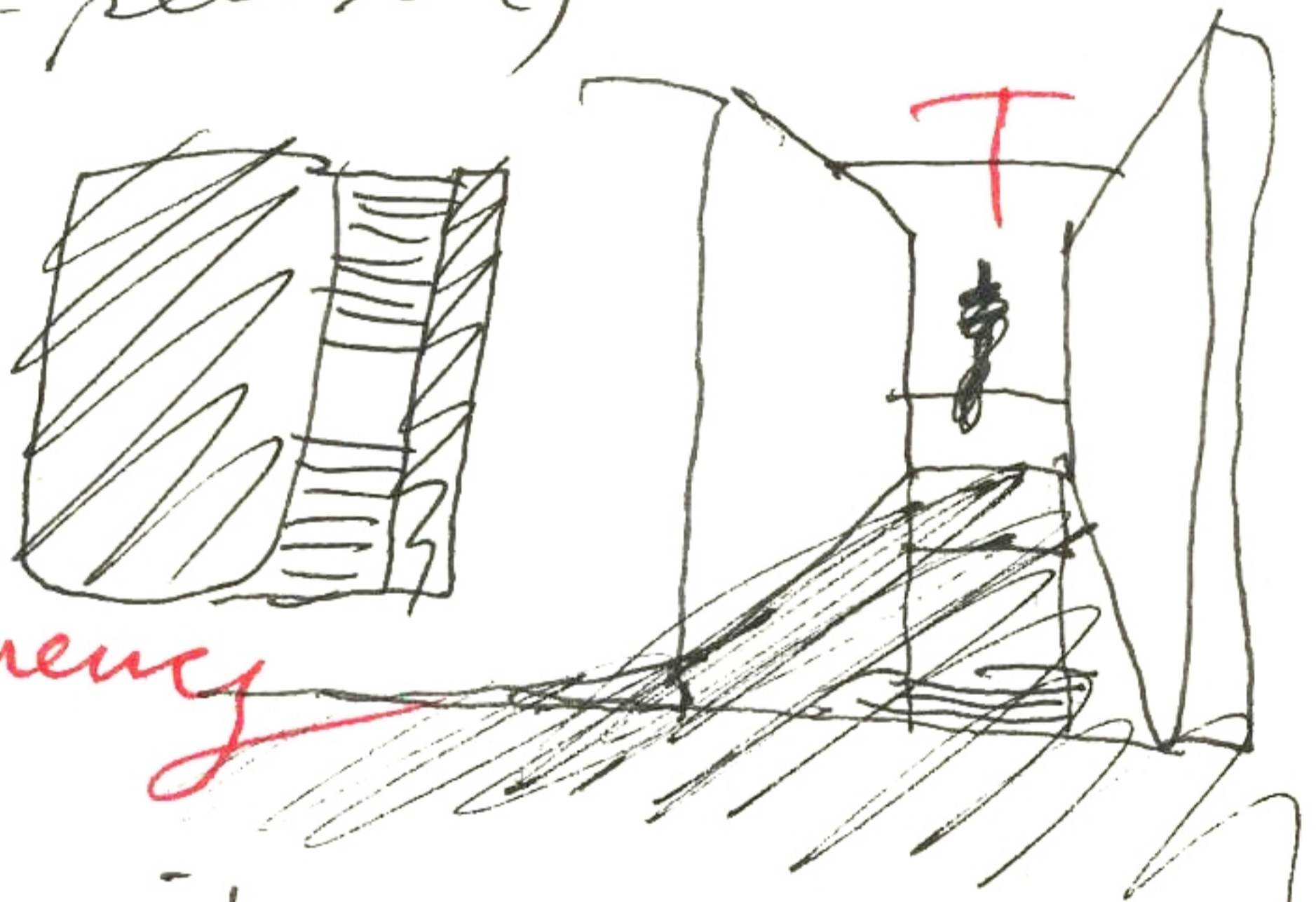

o

transparency

8)

quitar las  
Opelotas blancas

o

12

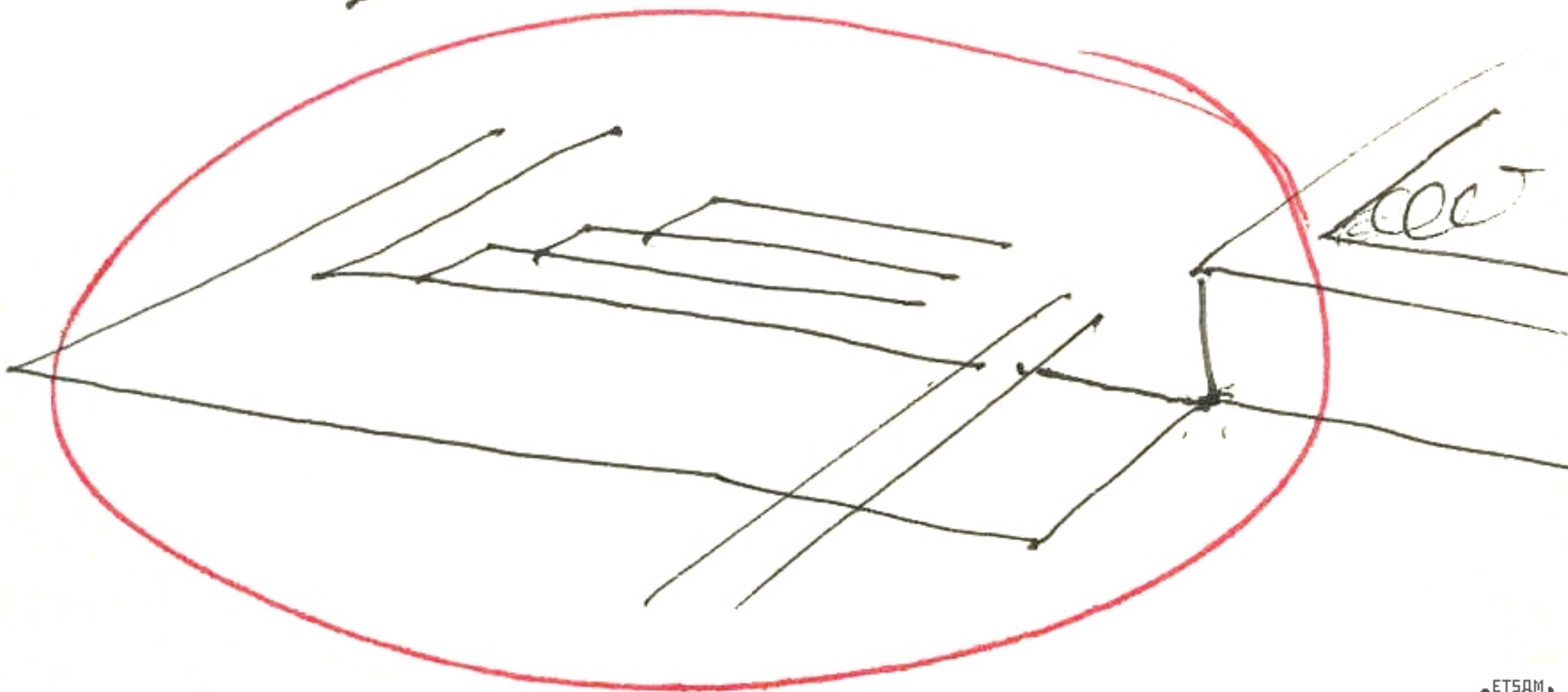
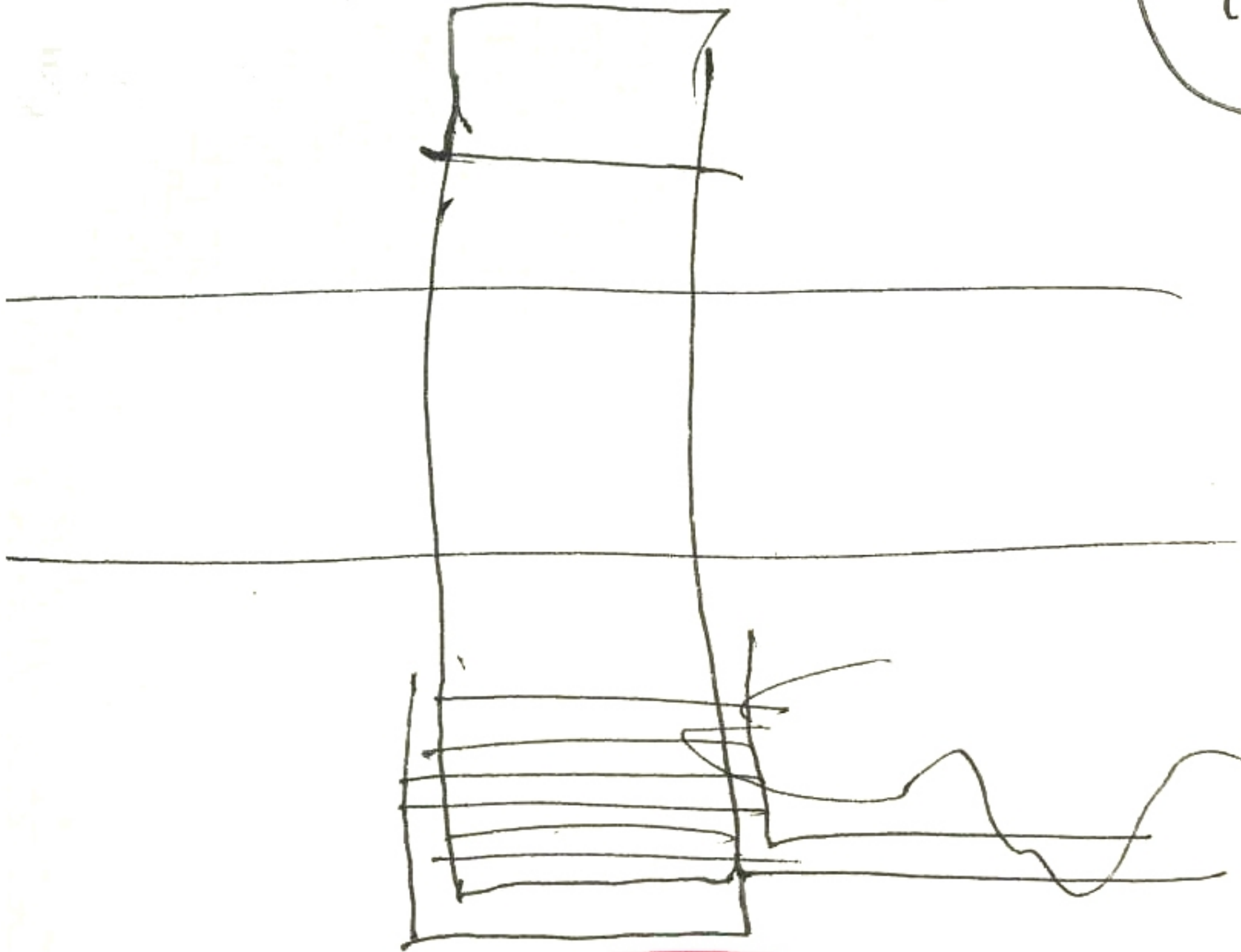

27



A



CASA  
INTRO

CASA  
EXT

introverted  
life

public  
life

vivir habitar.

Heidegger. / Habitar - pensar - construir

la claridad es la conferencia  
del fotógrafo

la claridad <sup>52</sup> en el vivir.



31

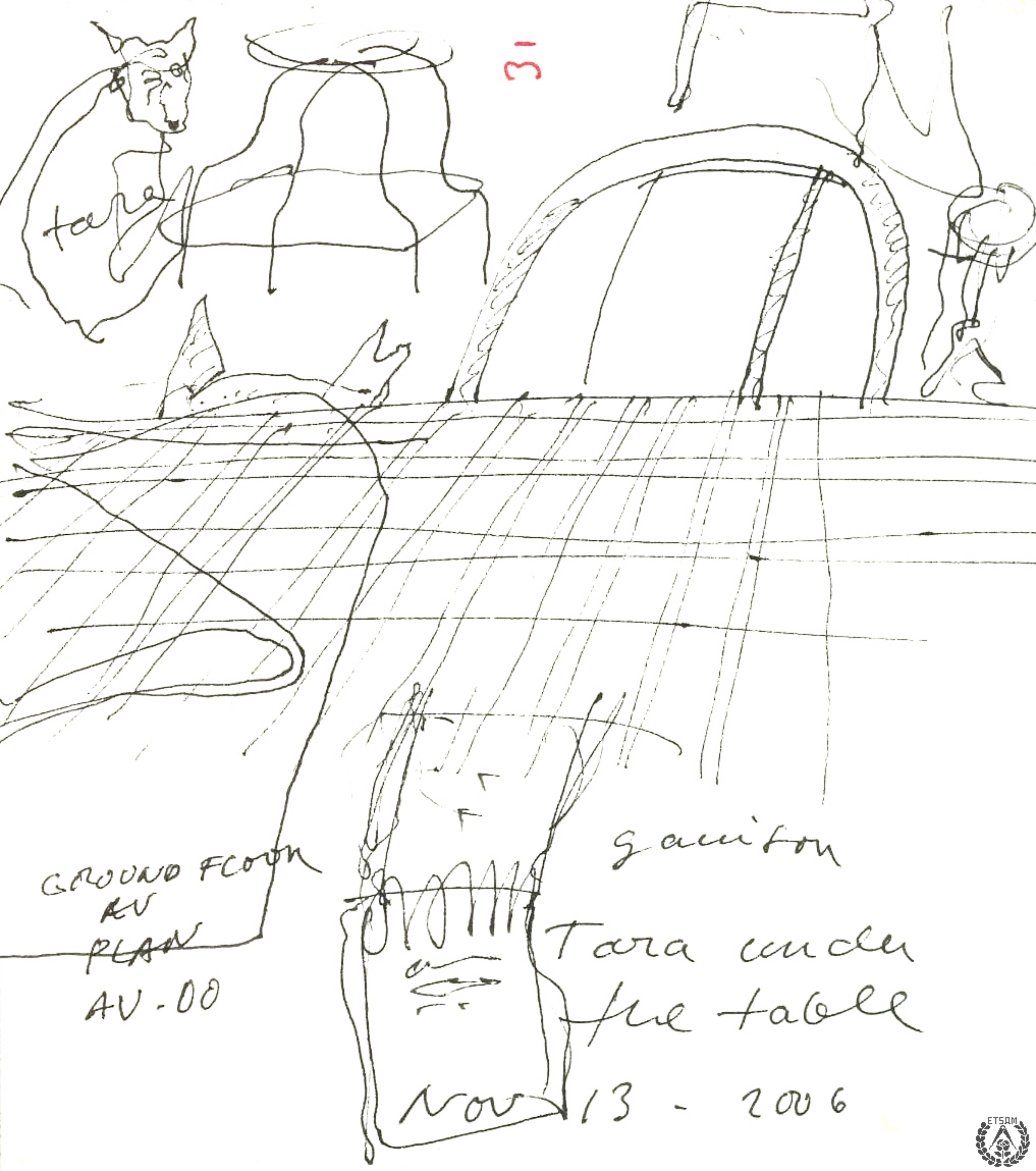

GROUND FLOOR  
AV  
PLAN  
AV-00

gaminon

Tara under  
the table

Nov 13 - 2006

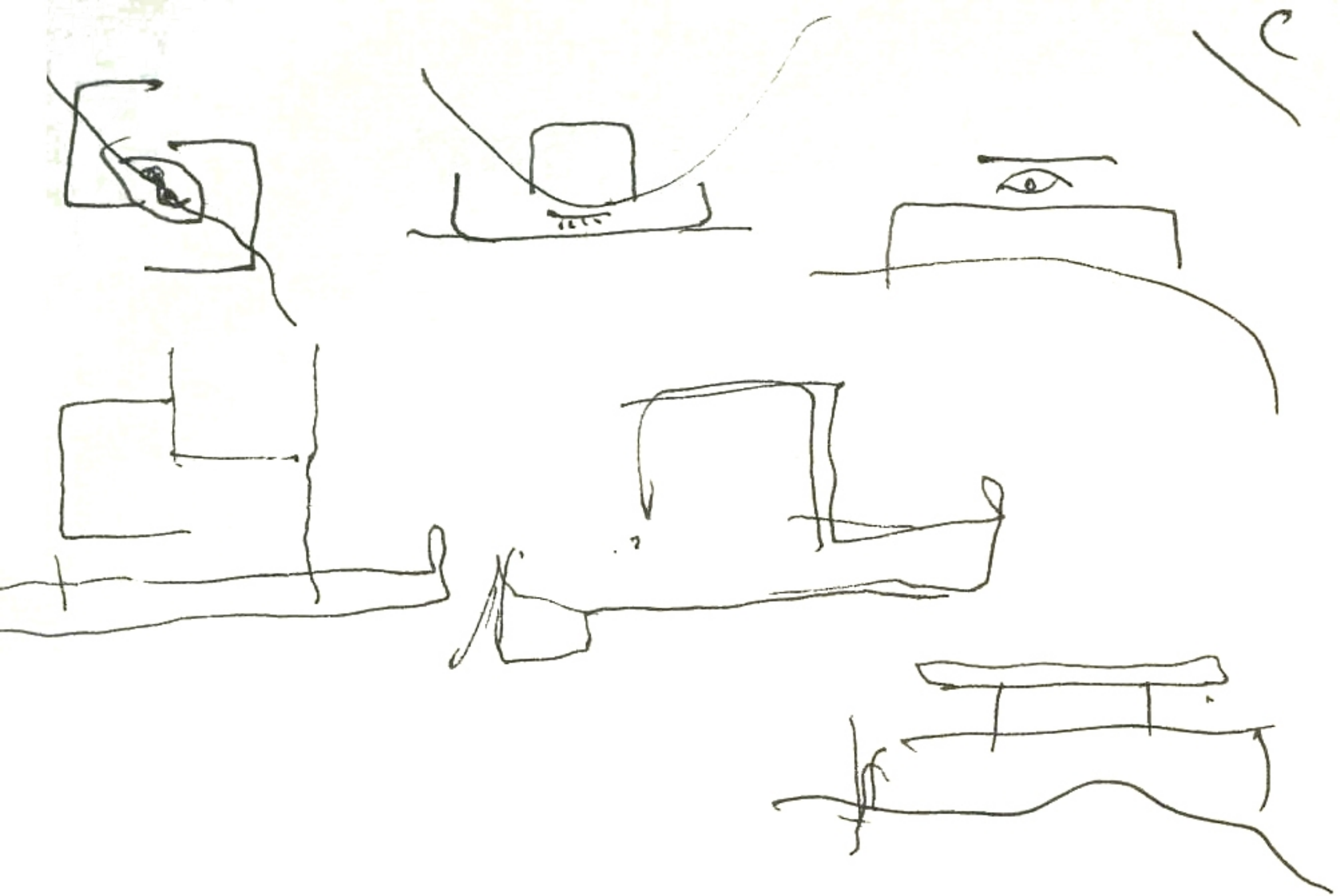

fall houses  
empty houses  
perfect houses

---

imperfect houses  
to be houses w

DUBLIN ①

NOV

17

2006

orange



fruit salad.

Breakfast at the <sup>5</sup> callaghan Hotel





visita el jueves  
antes de LISBOA



24 mar 2006



53

? Can we see above?

↓  
can  
side  
? ? ?  
? ? ? ?  
? ? ? ?

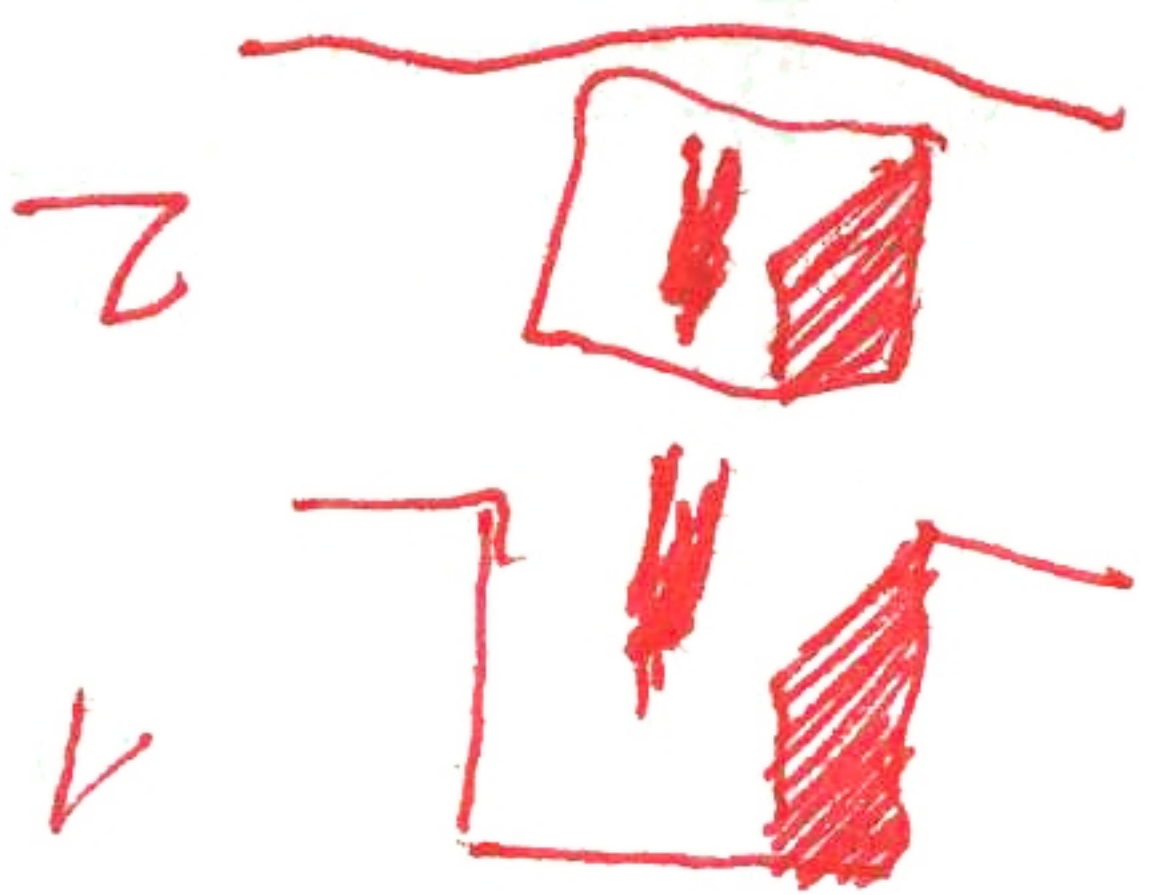
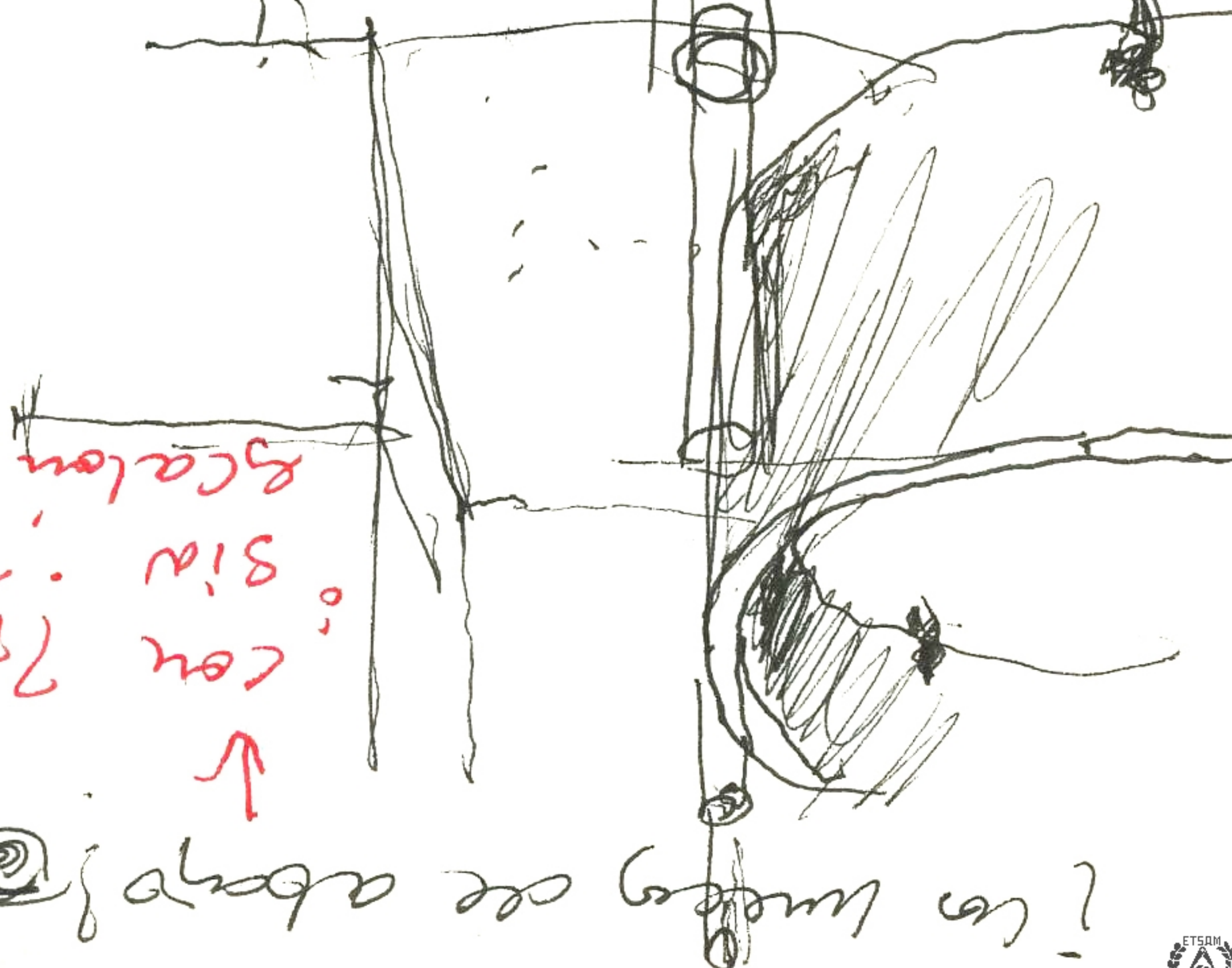



aver  
ver en  
la

marque de  
ESTE  
p. de vista.



donce el  
plano vertical  
se convierte en línea

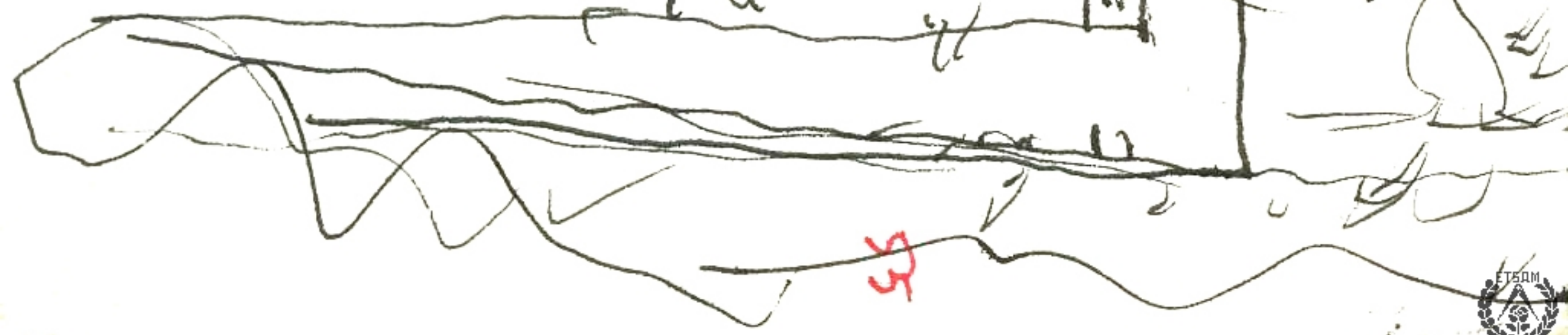



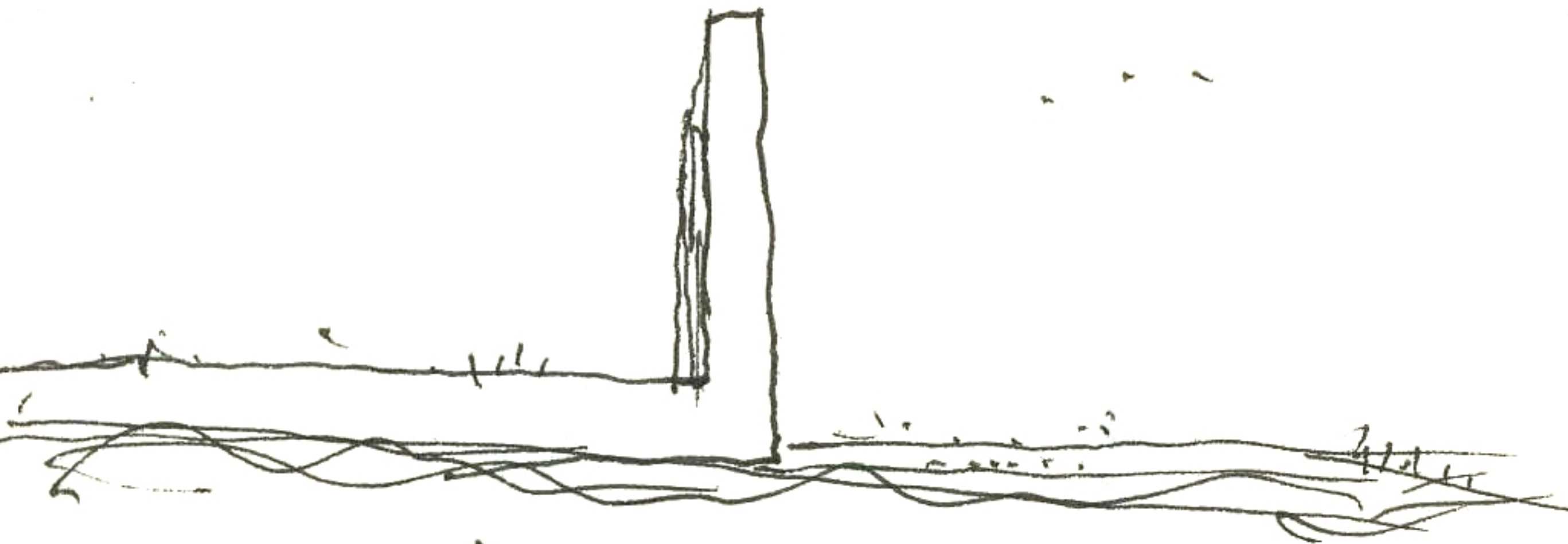

↑ eliminar las aceras



↑ quita los palmeras  
↑ igualar árboles.

• eliminar las 3 de las esquinas

① quita? transformador

7 encuentro de fran  
plano con acera.

1) escalón.

2) acuerdo

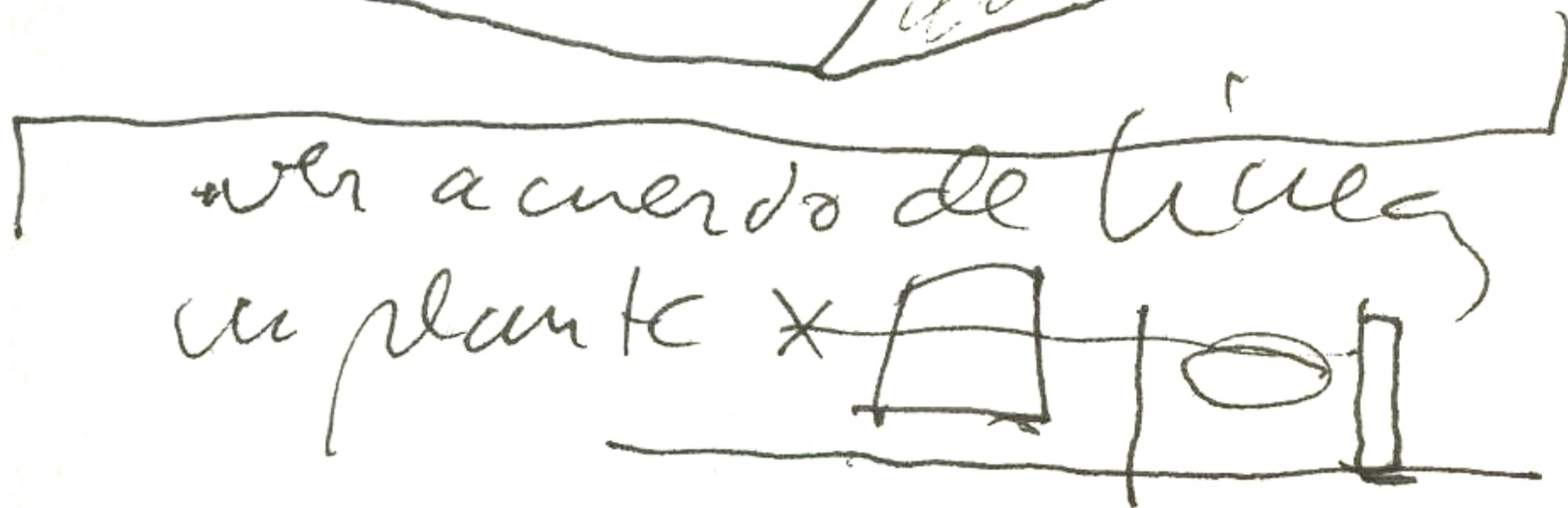
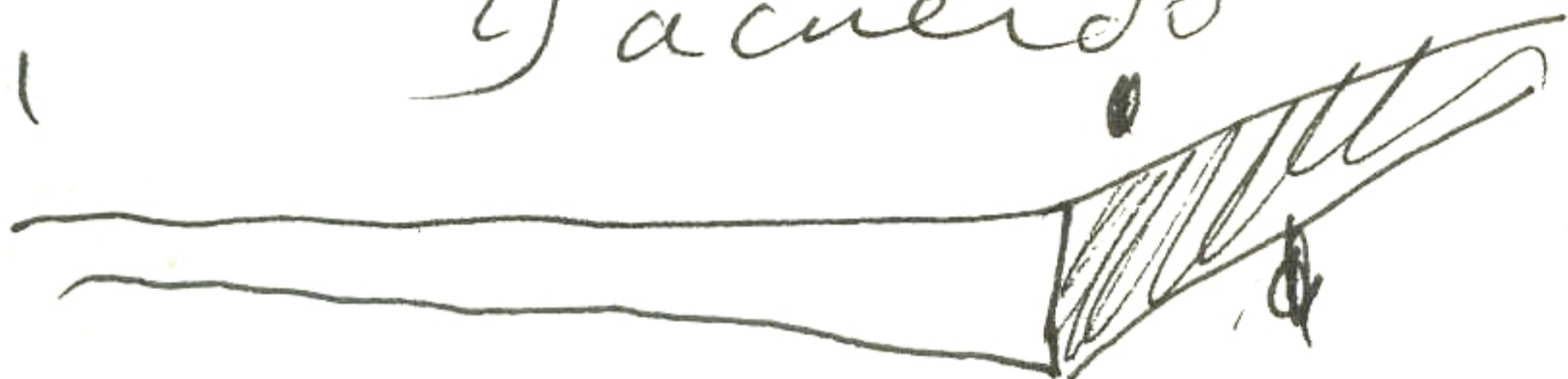

57

23 nov 2004



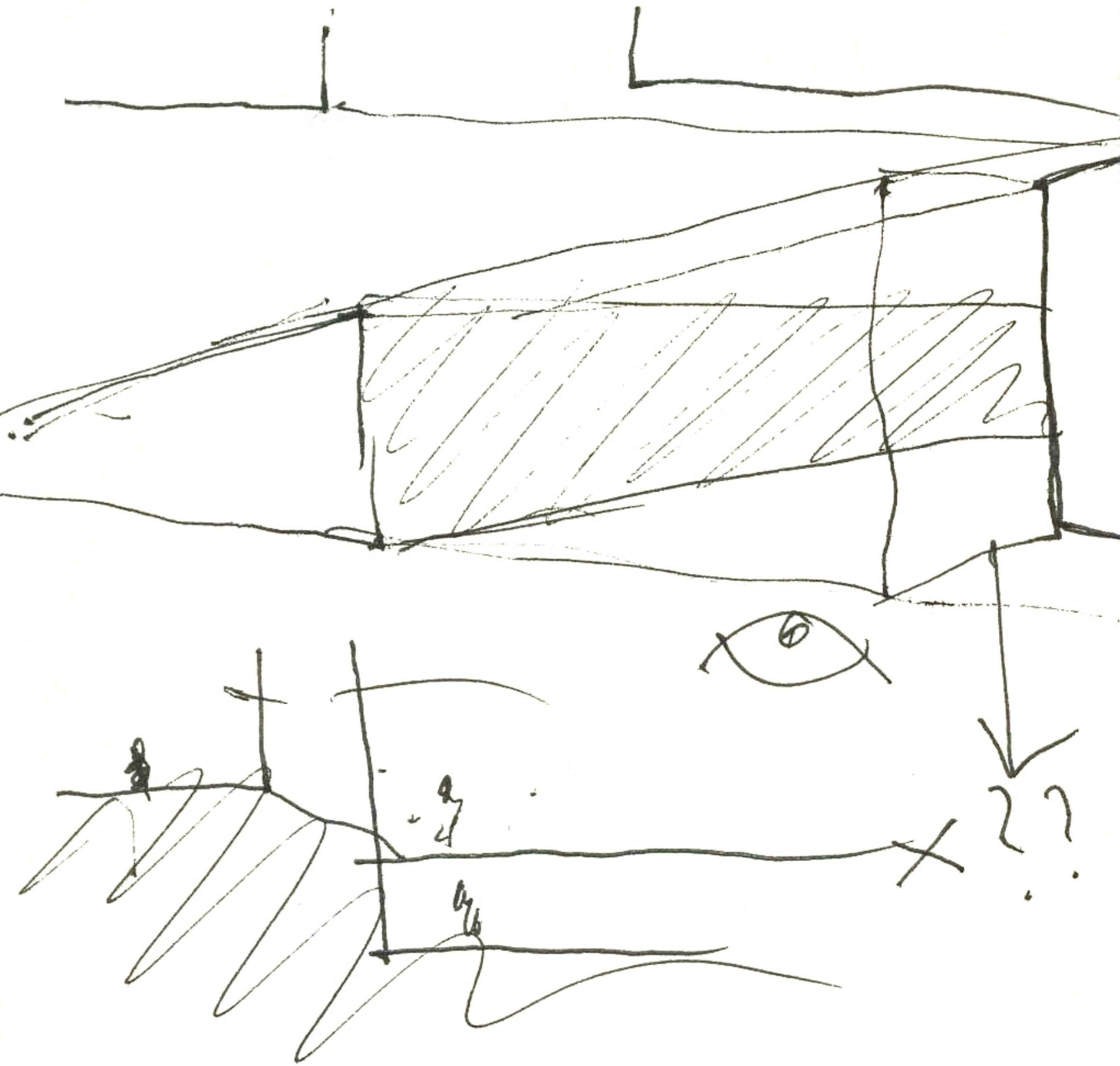

59

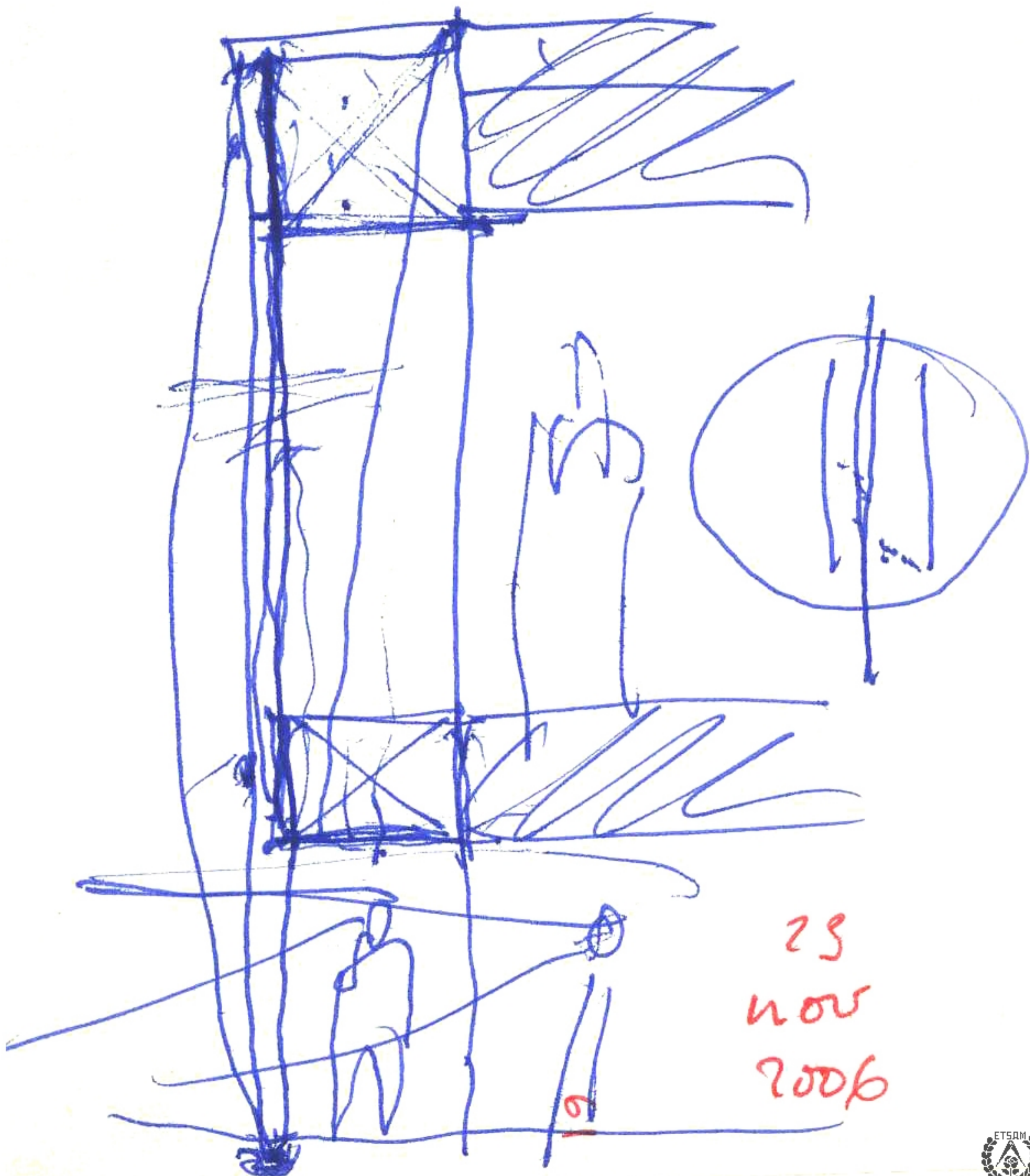

23  
Nov  
2006

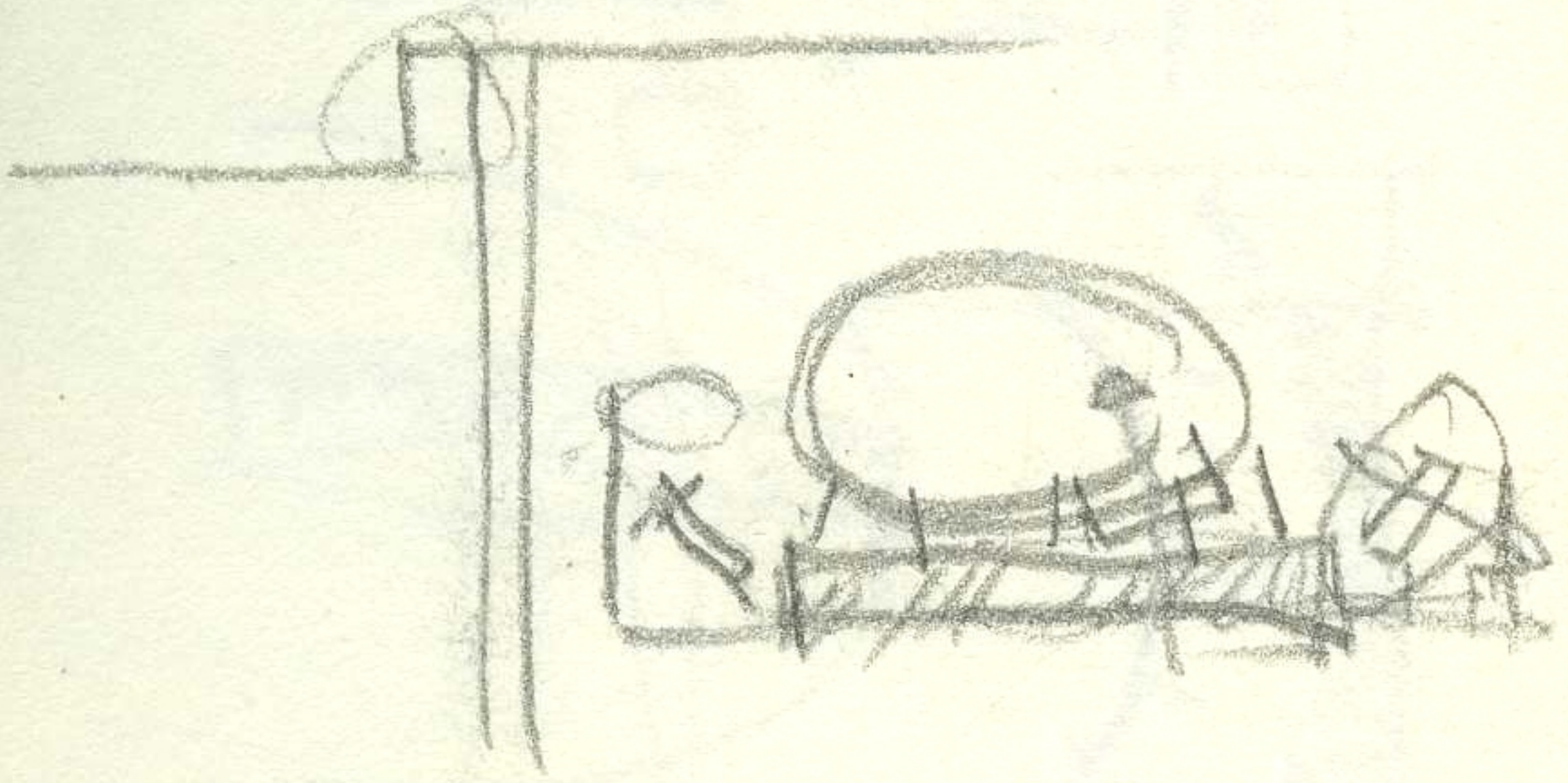
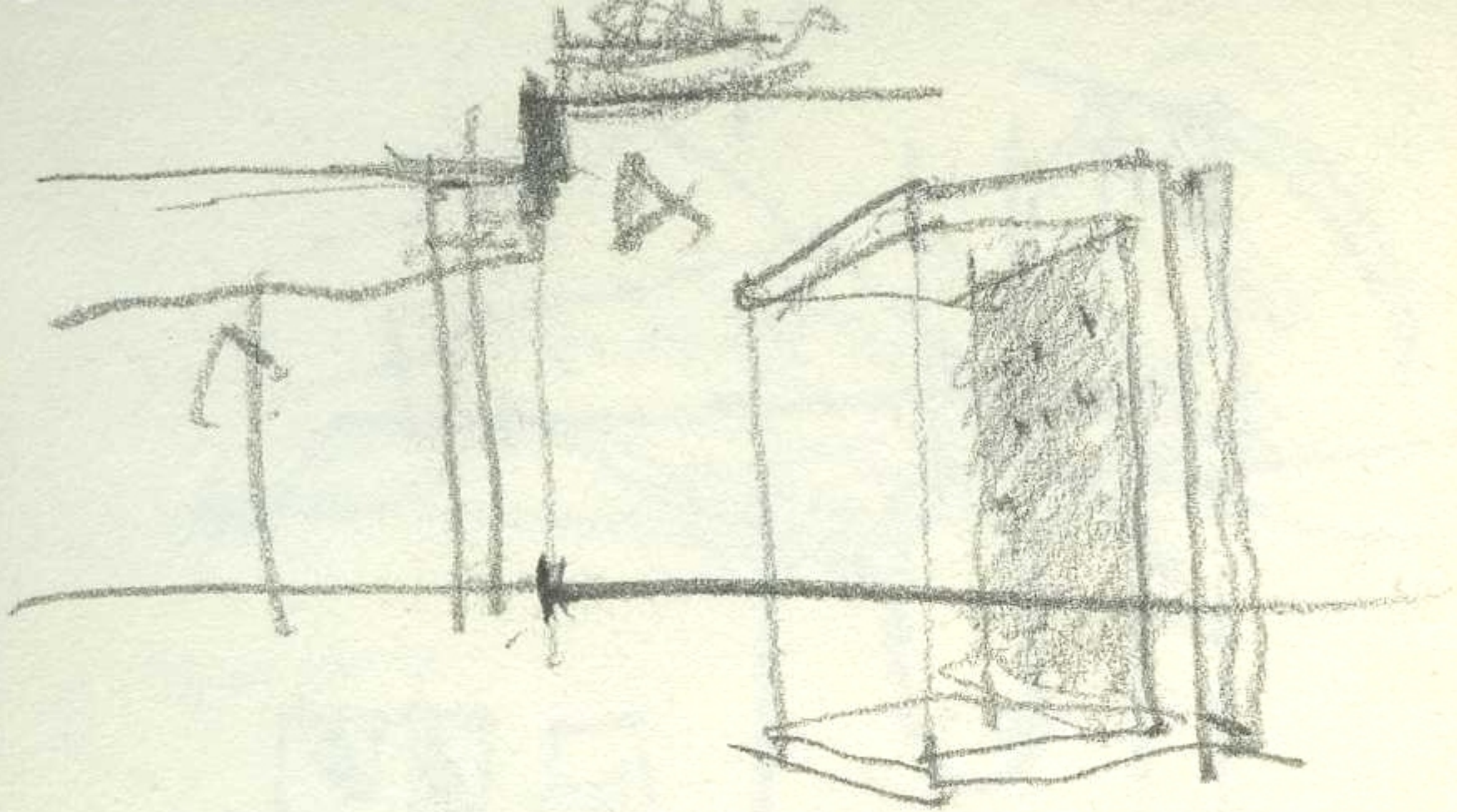



Dic.

22

2006

en  
Cádiz



puertas de hierro.

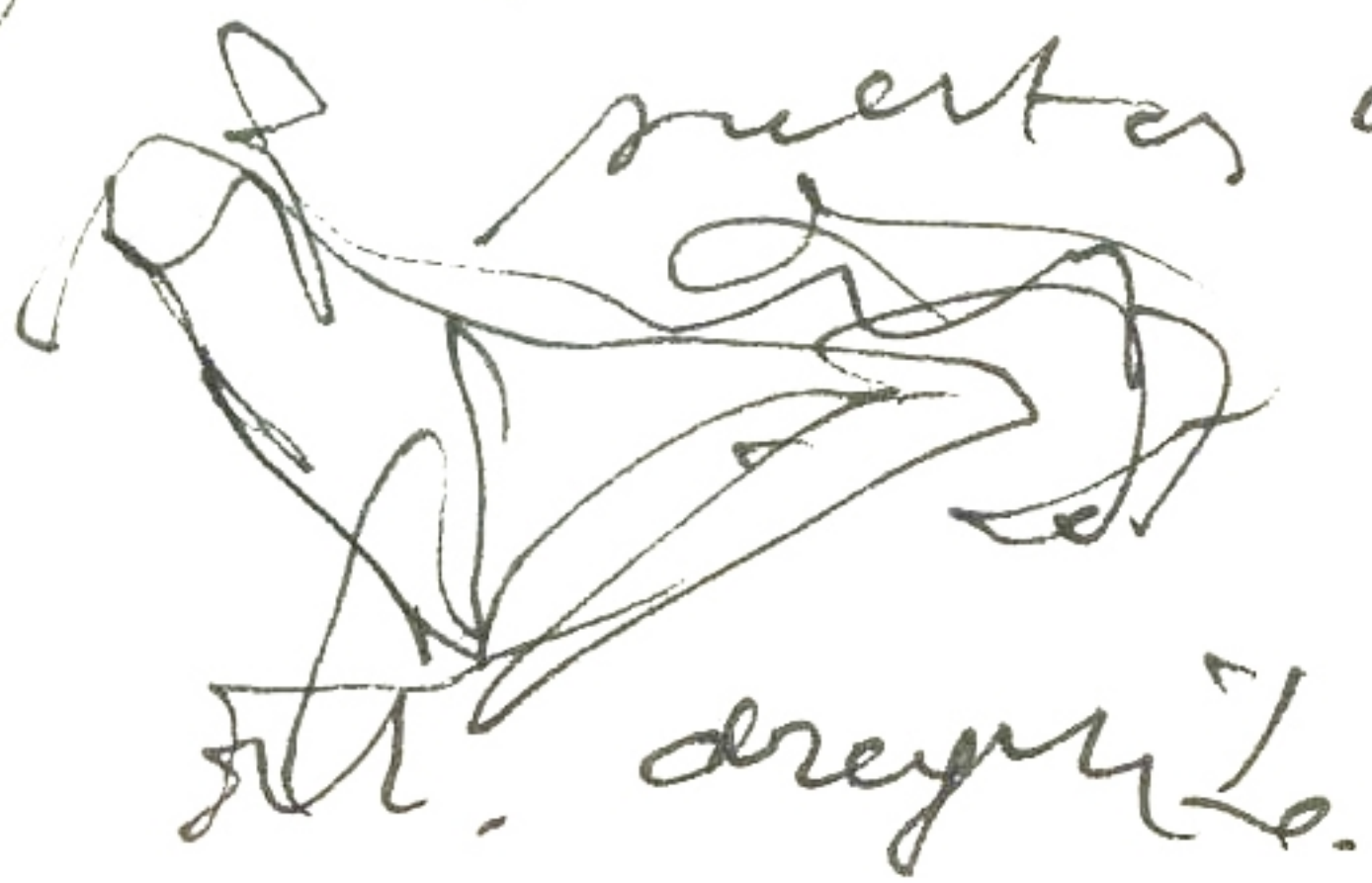

St. dreyer's.

alca  
vuelta  
el Drago

7 esquema de D.

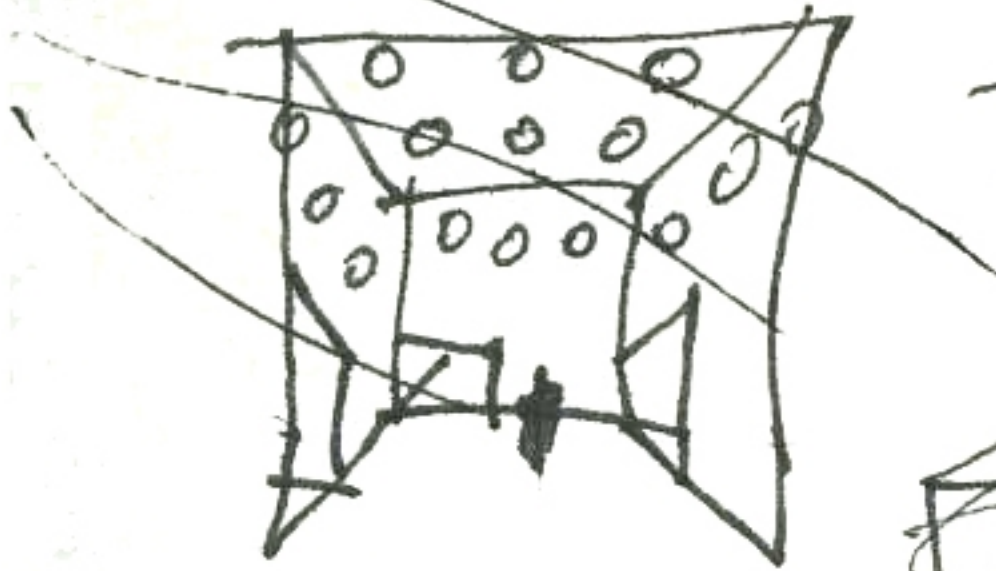

Zenith

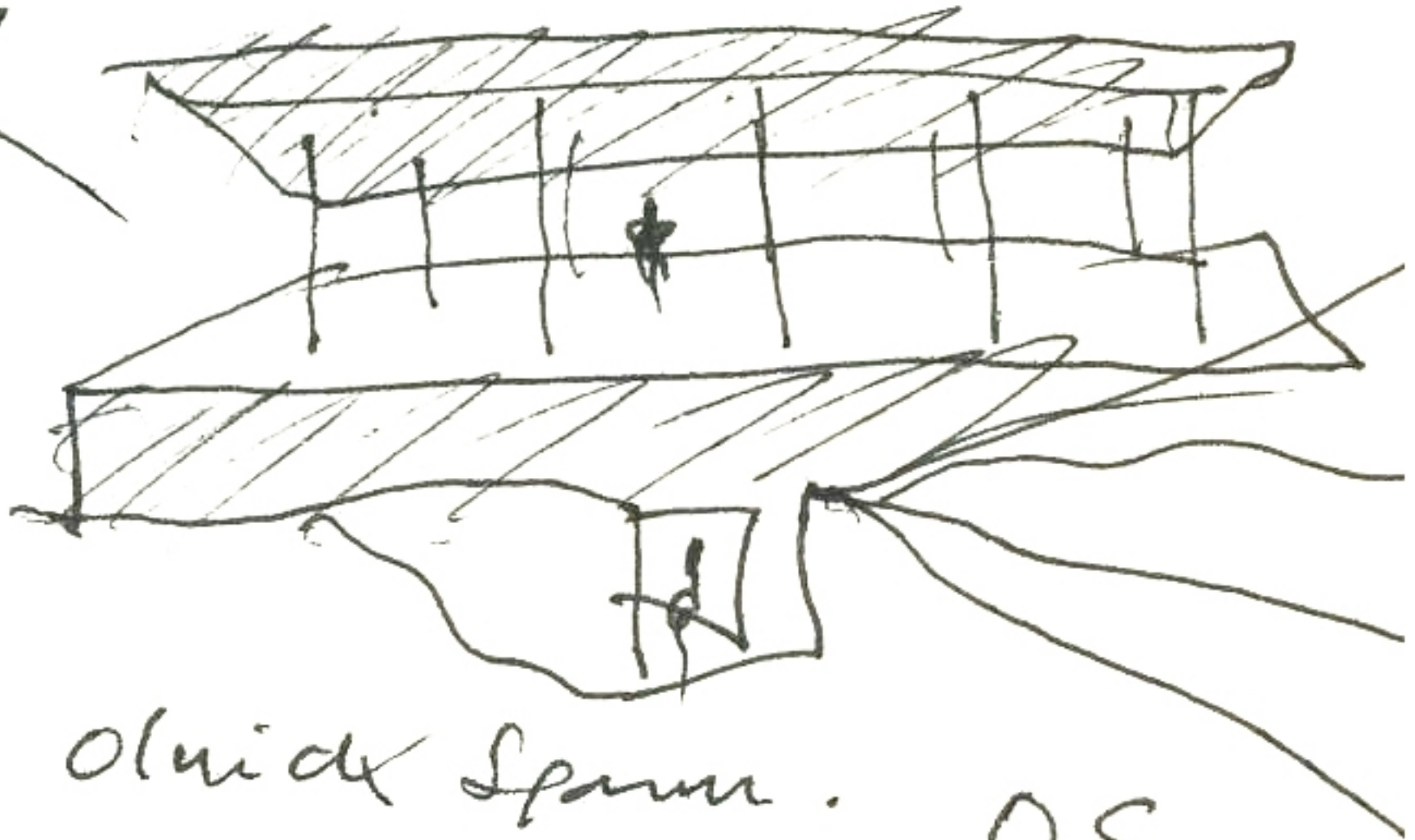

BT

Olvidx Spann.

NO lamp.

OS

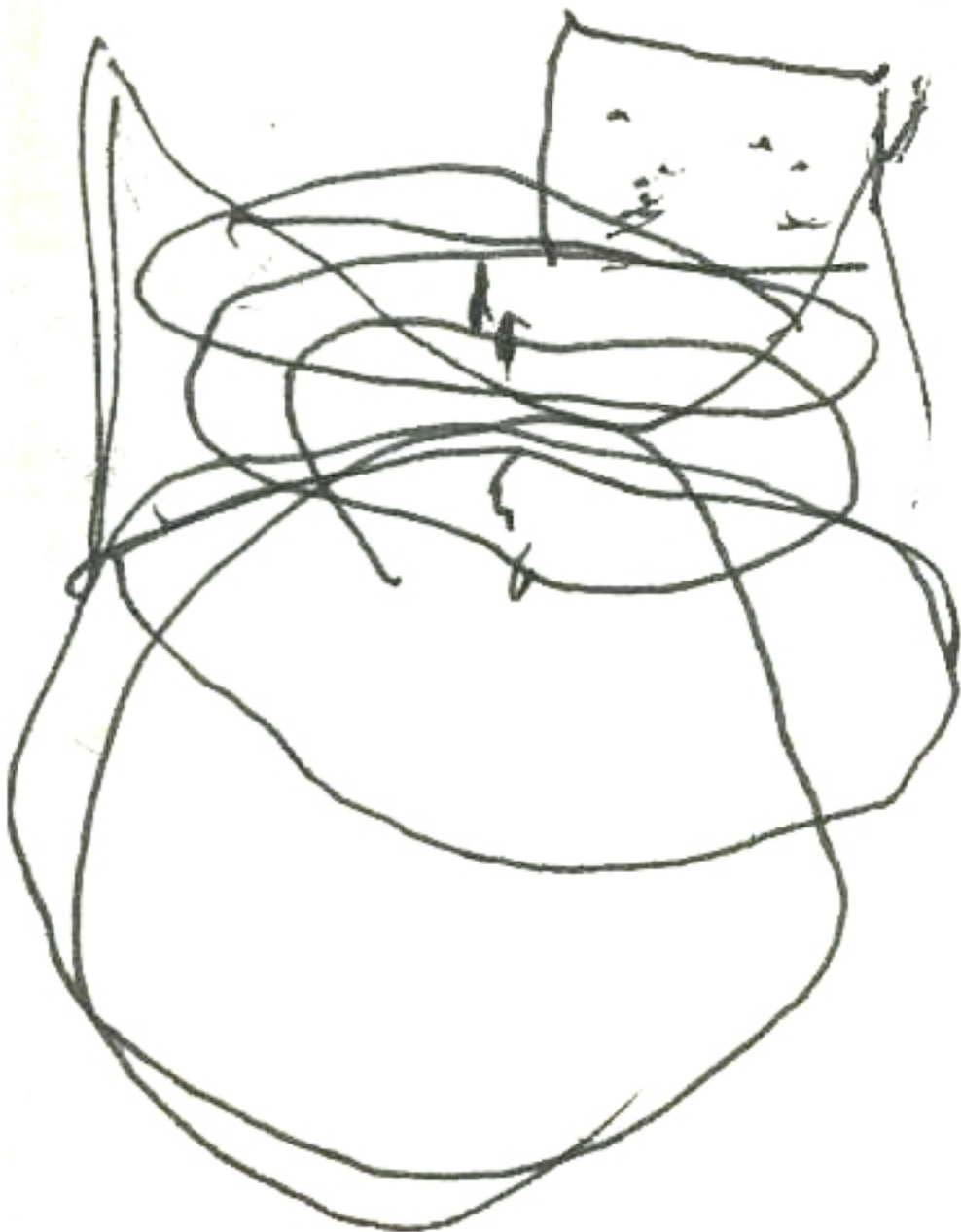

MA

103



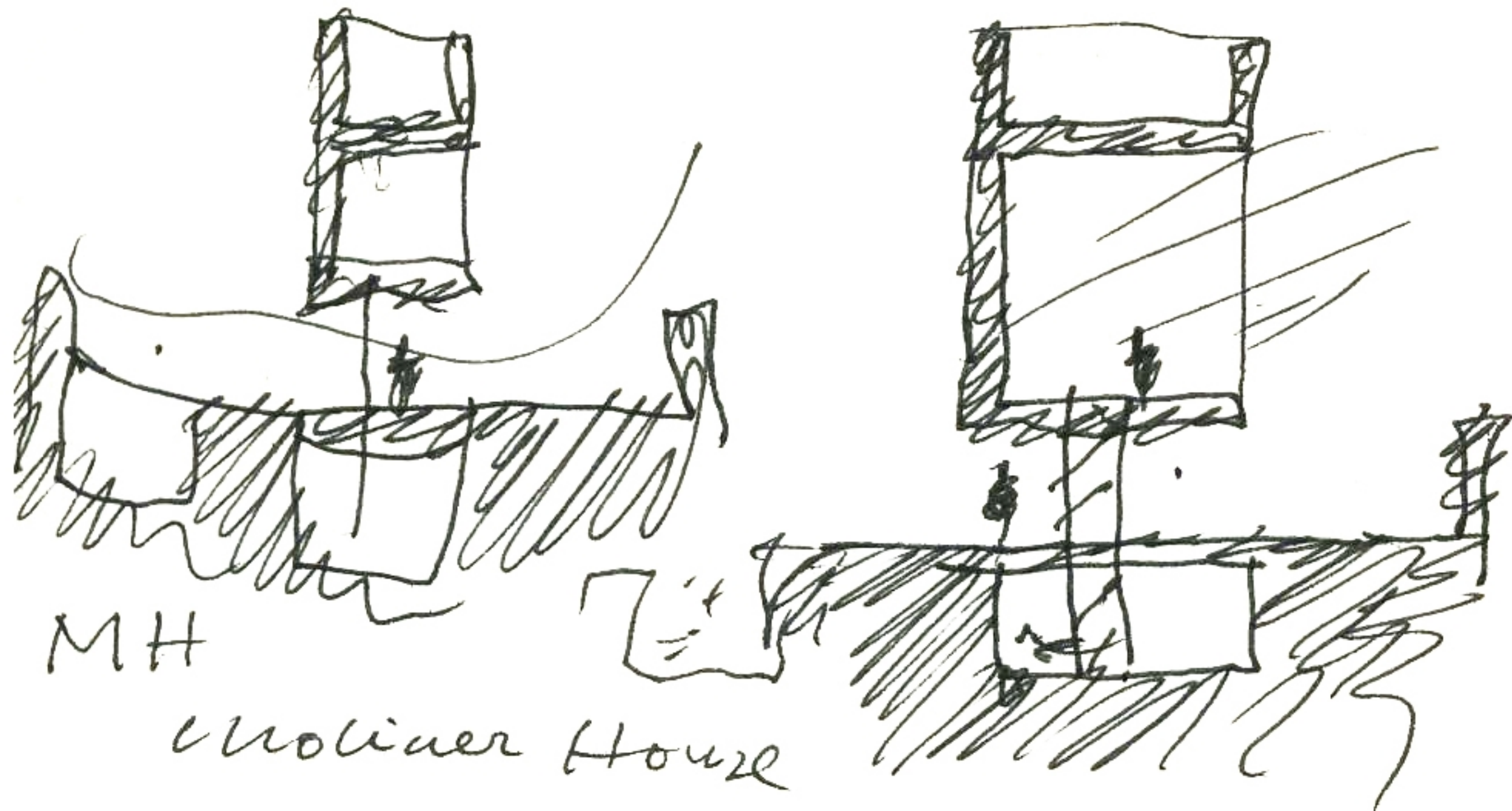

MH

Molinaer House

( P. PARADA - J. FERNANDEZ )  
2042. T 0'9°C.  
el 30 diciembre de 2006 )

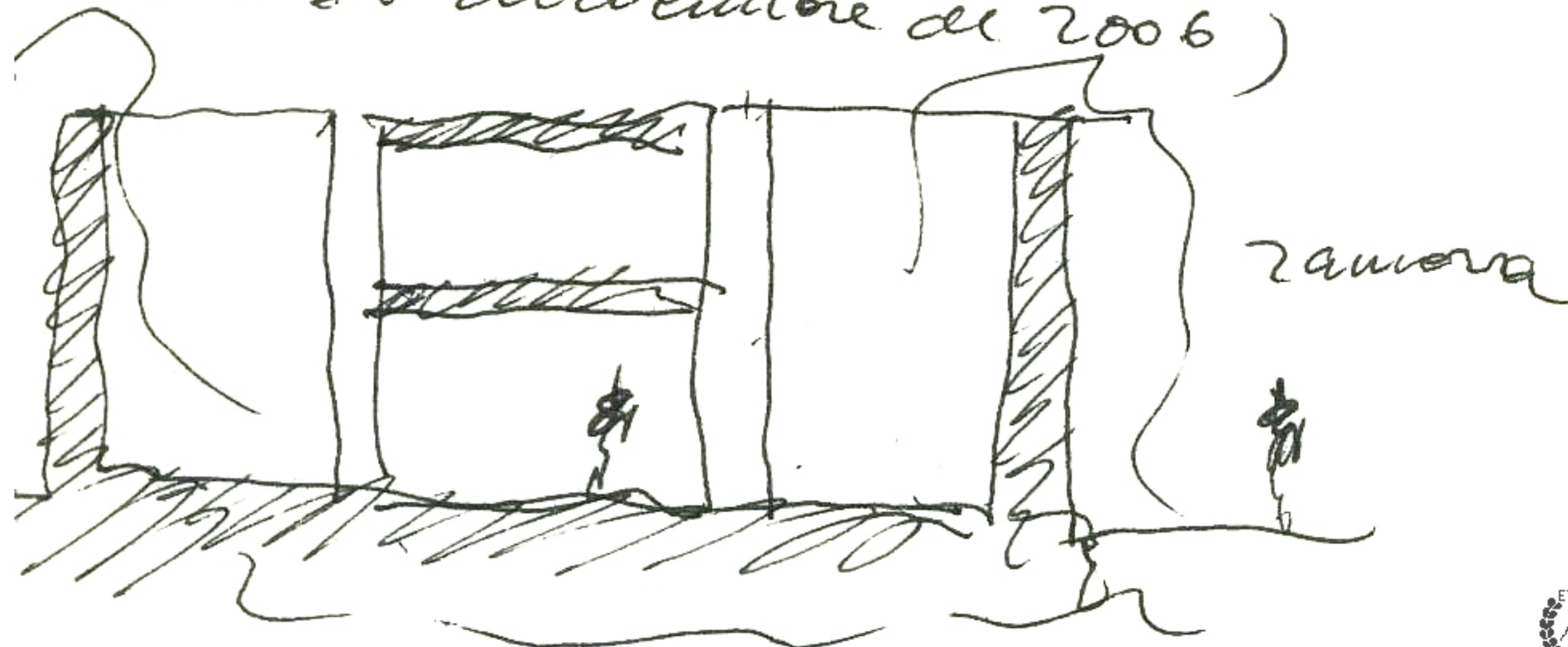

Zanovera



dibujar  
esquemas de los  
Proyectos

(+ cercanos a las  
medidas)

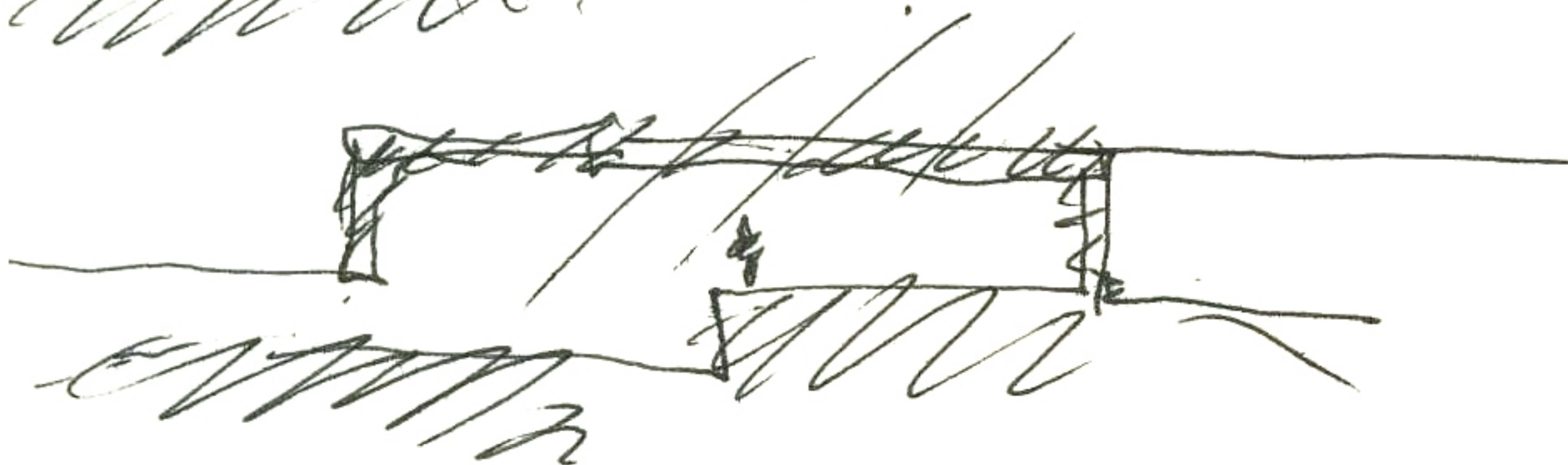

Zodiac 2000

105

DUCK

ZO'CALO



~~SOCKE~~



PLINTH

SWAN

PODIUM

~~BAST~~

