

1996 - 1997
Agosto 9 diccionario

X

~~7~~

X

Two possibilities

1 Acropolis.

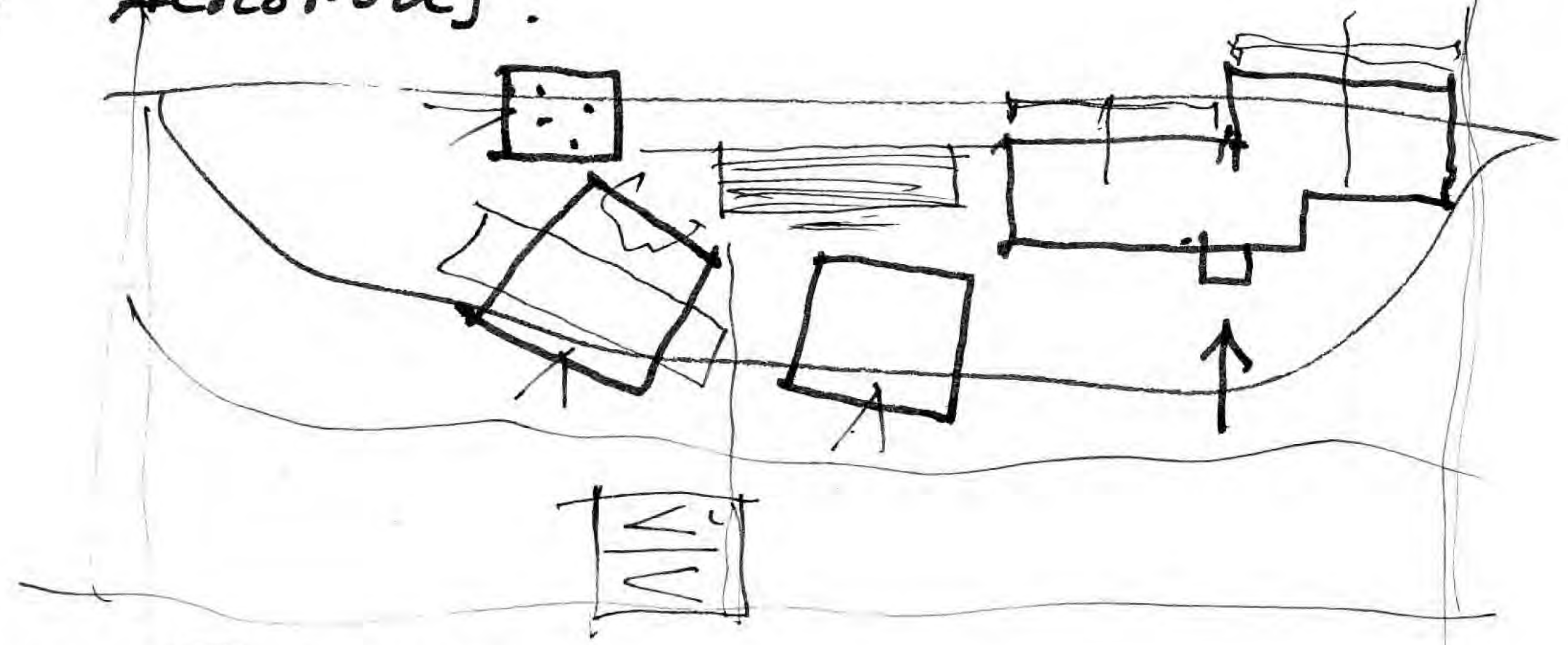

2 FORTRESS.

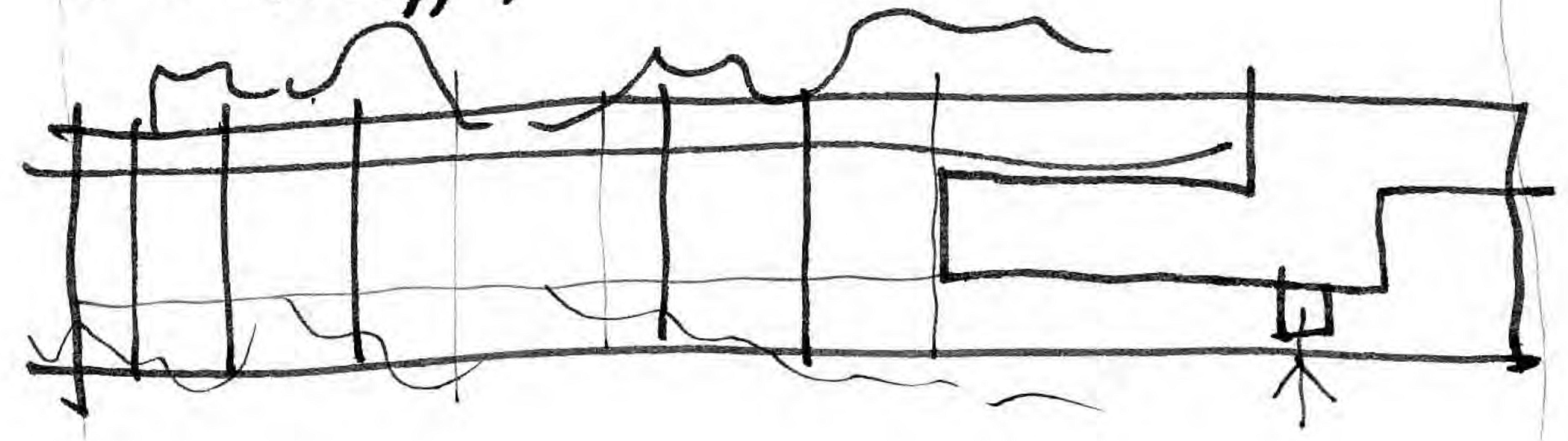

volver a saber cual el programa.

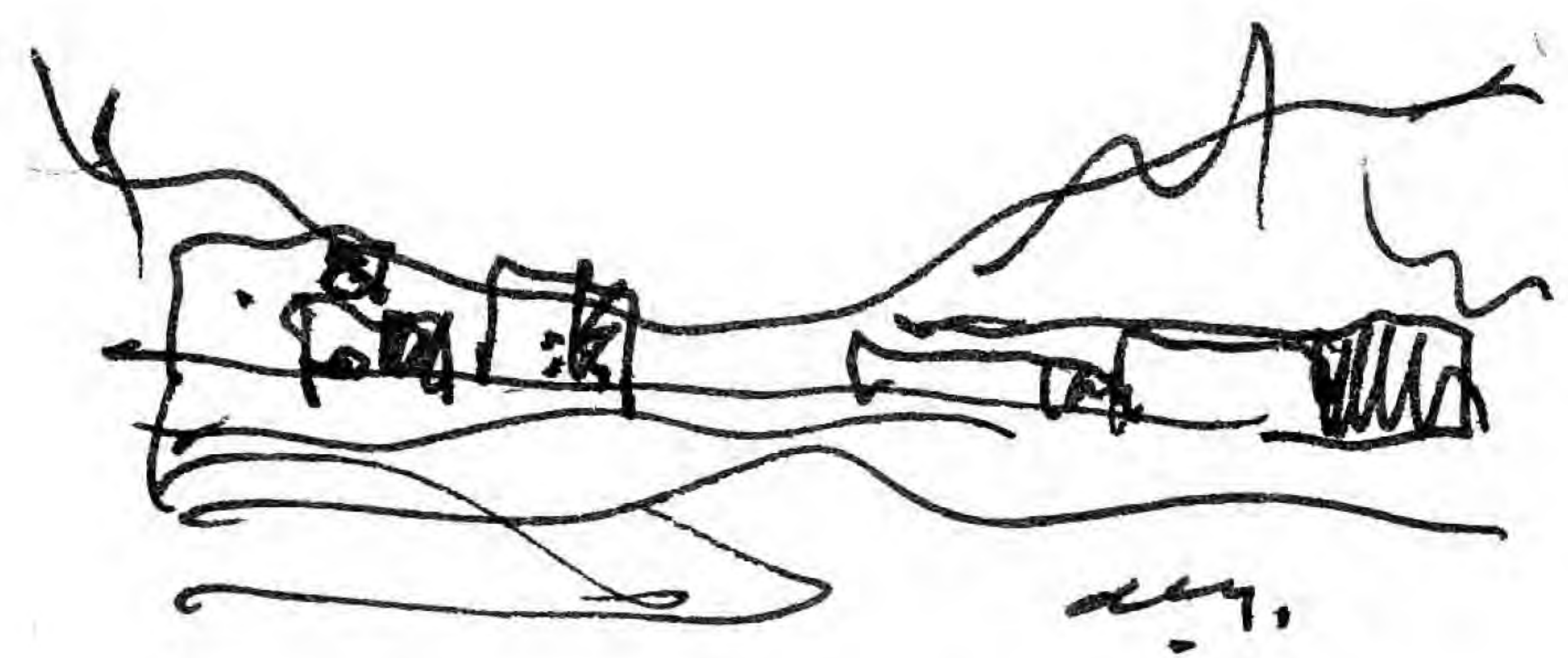

Acropolis.

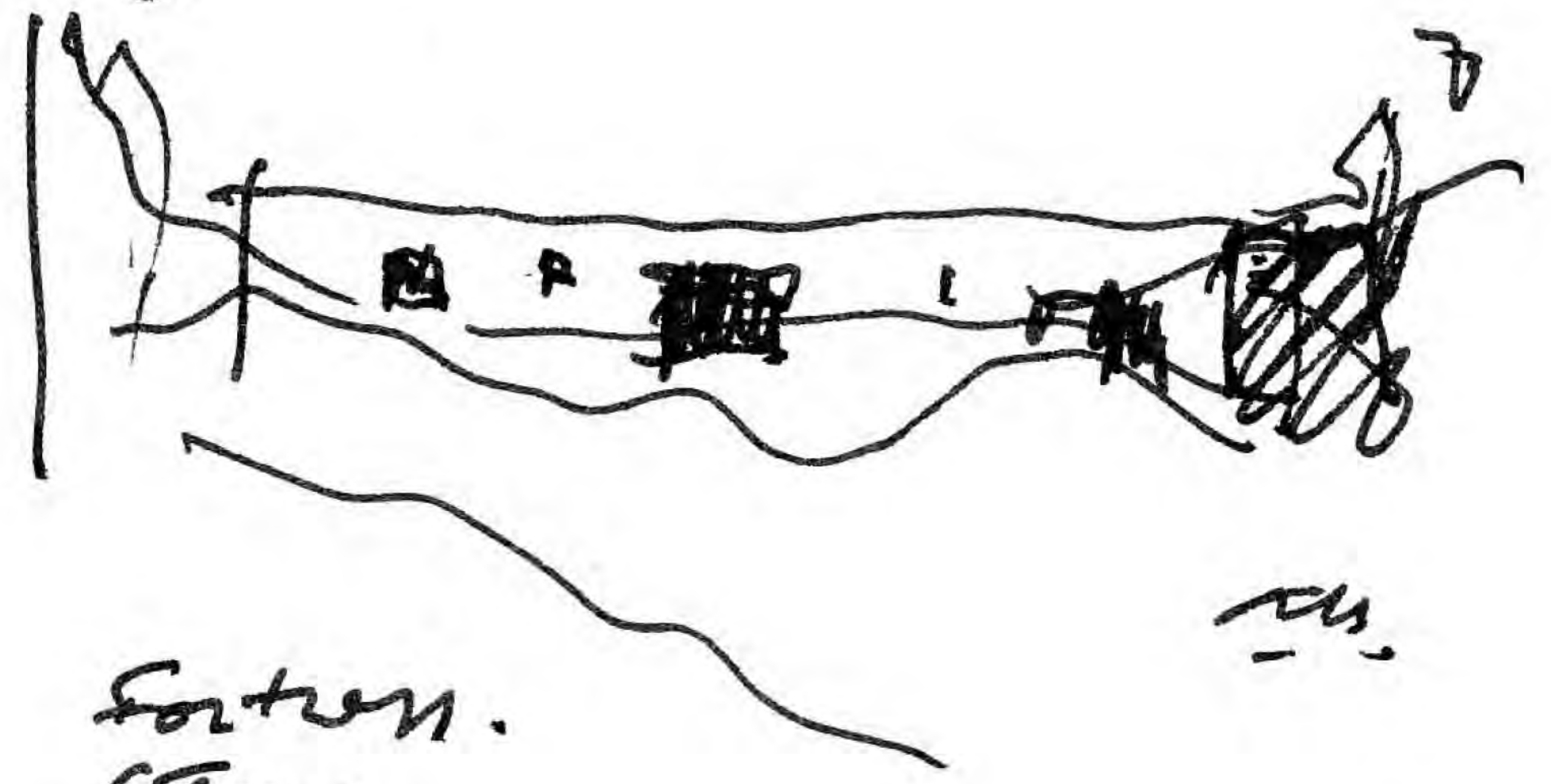

Fortress.
(Fo.)

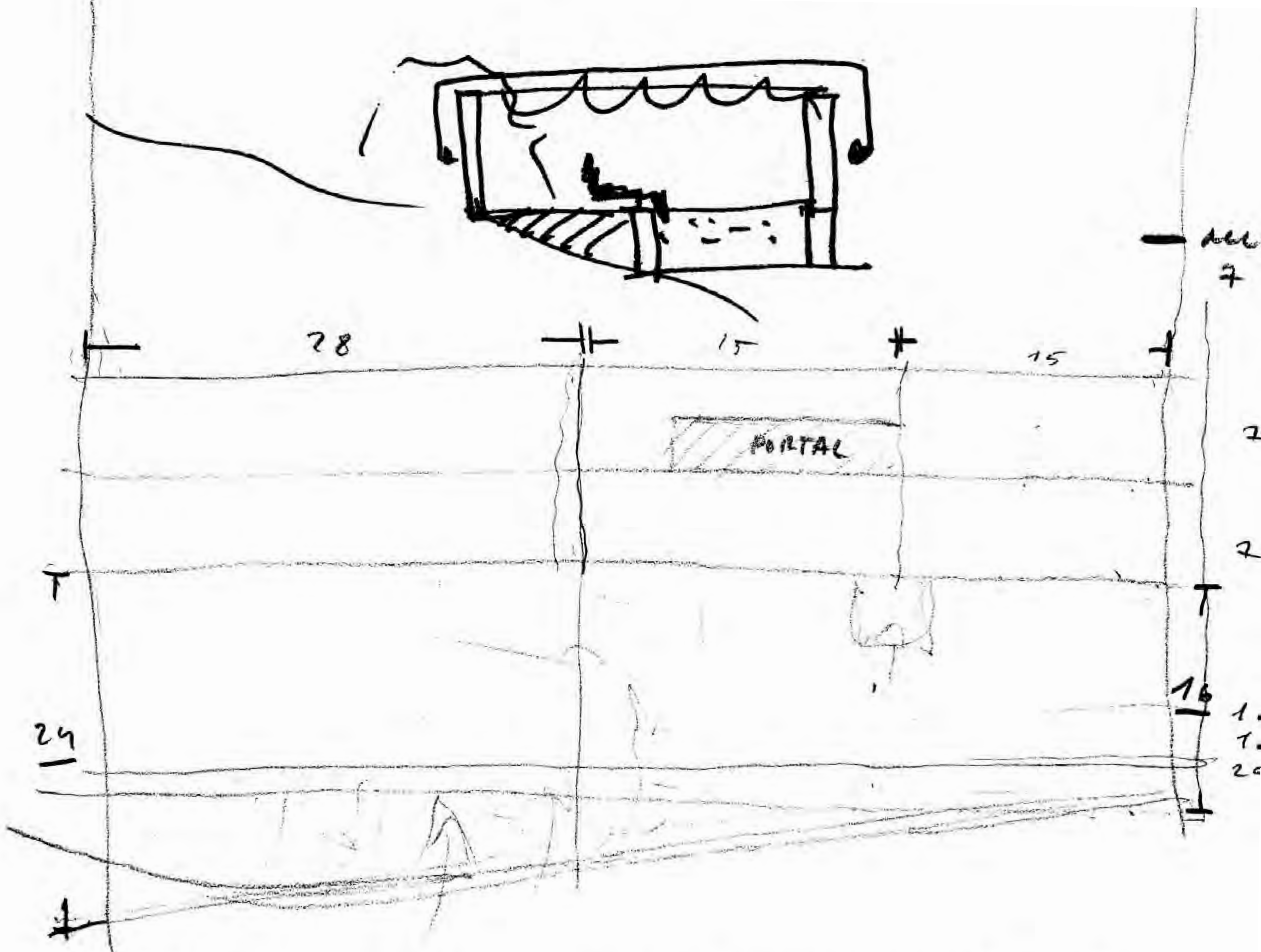

- 7 cosas nuevas tras la conversacion etc...
- 7 terreno con ROCA. / 7 piscina CATA
- 7 si a lo PAVILION.
- 7 gran ~~SEATING~~ LIVING ROOM

01

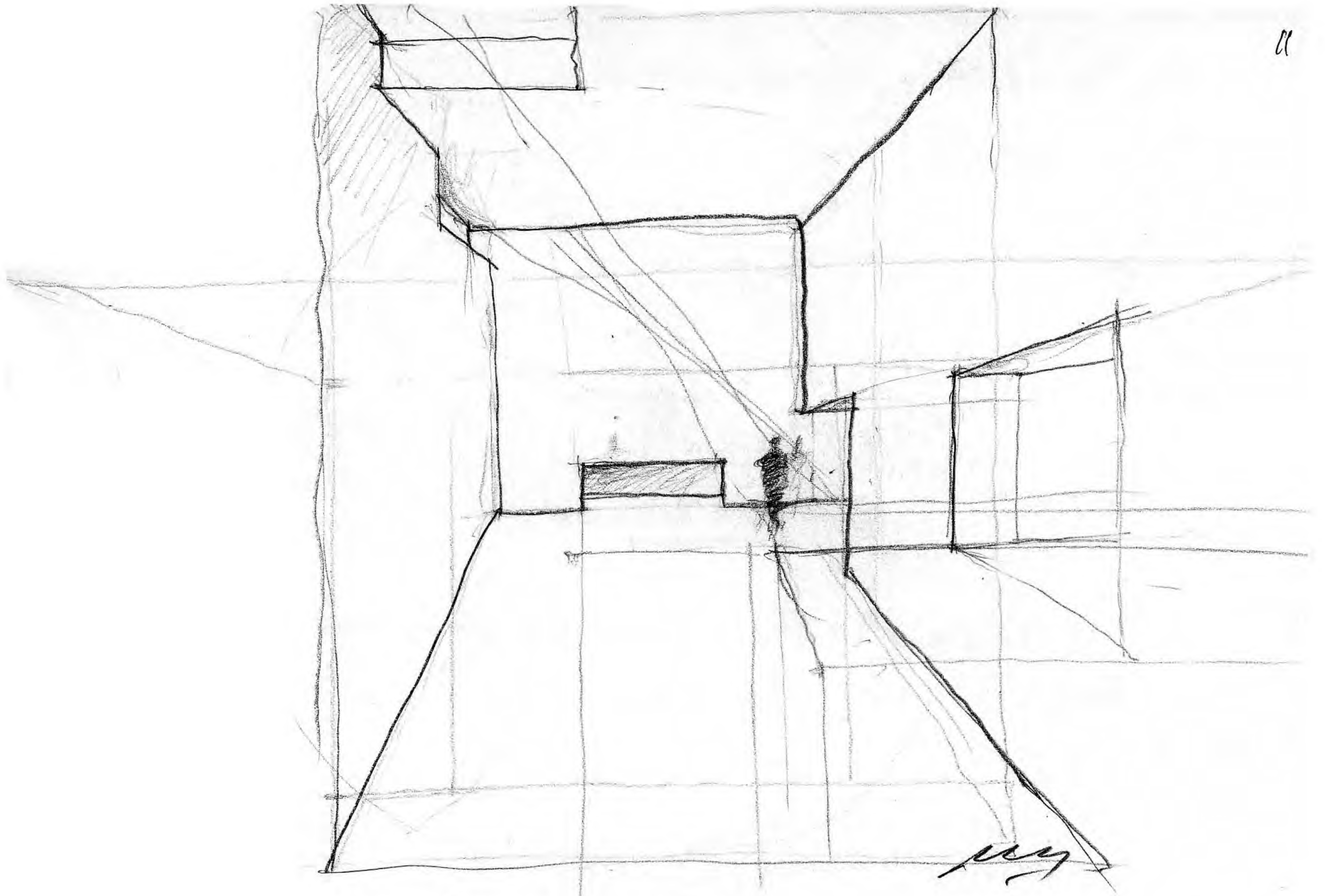

Main house.

August 6. 1995

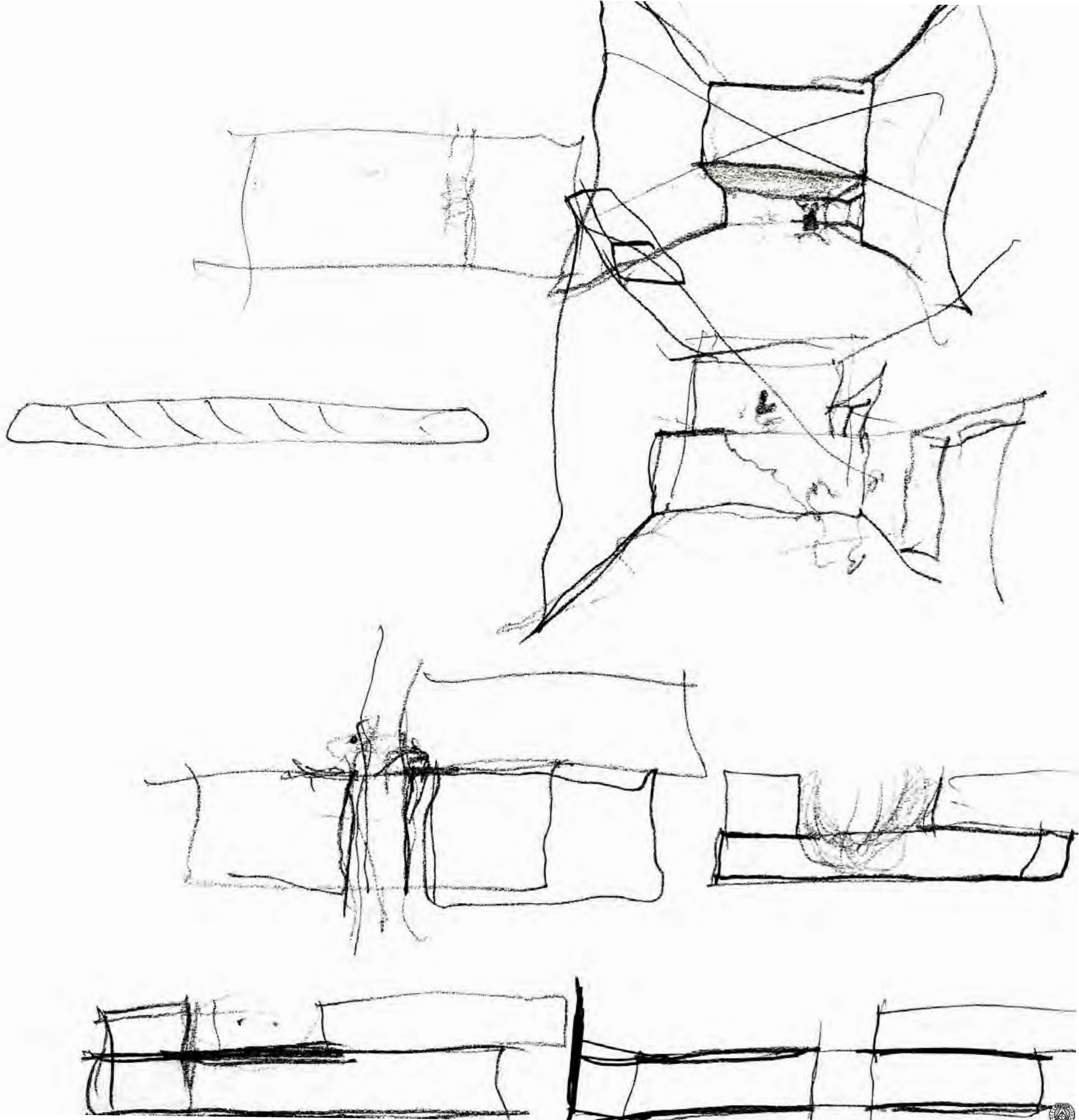

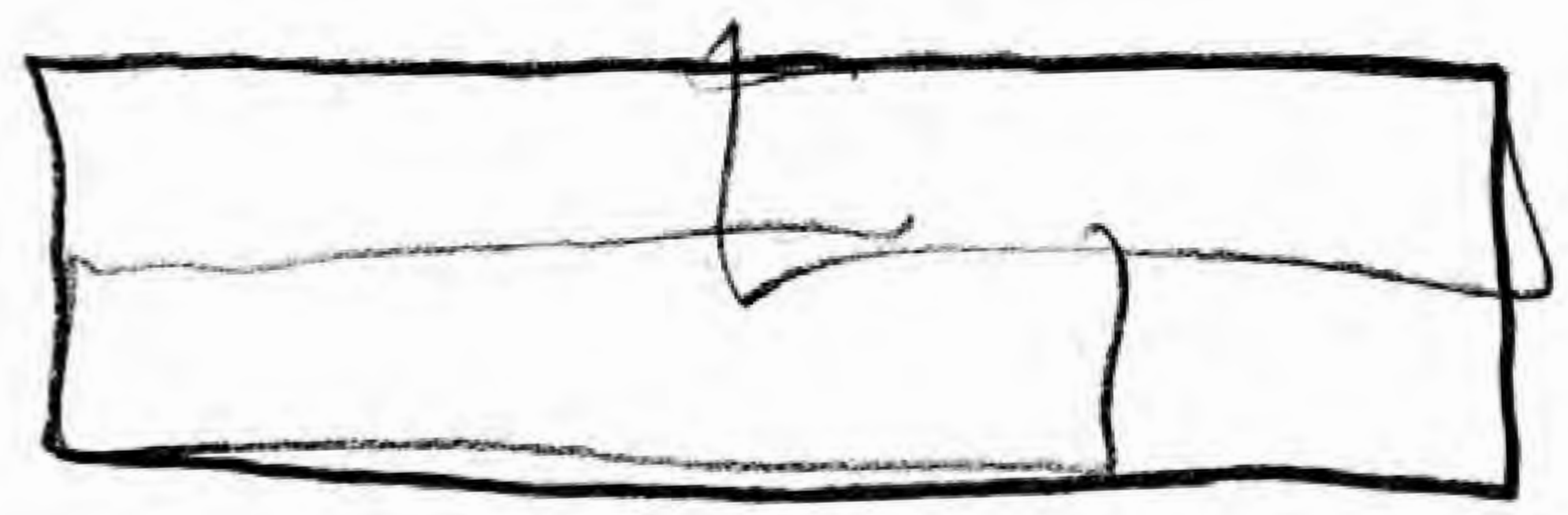
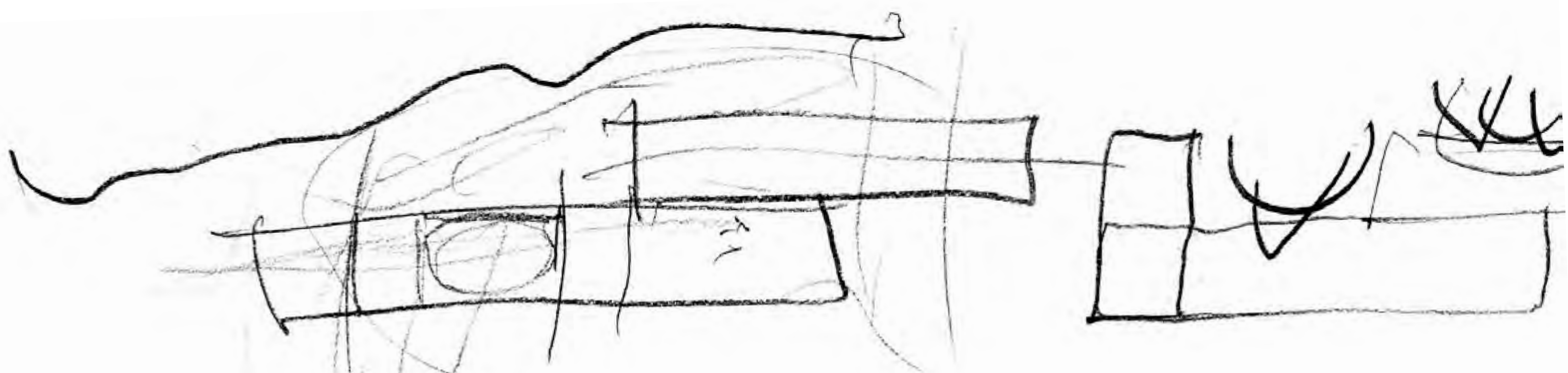

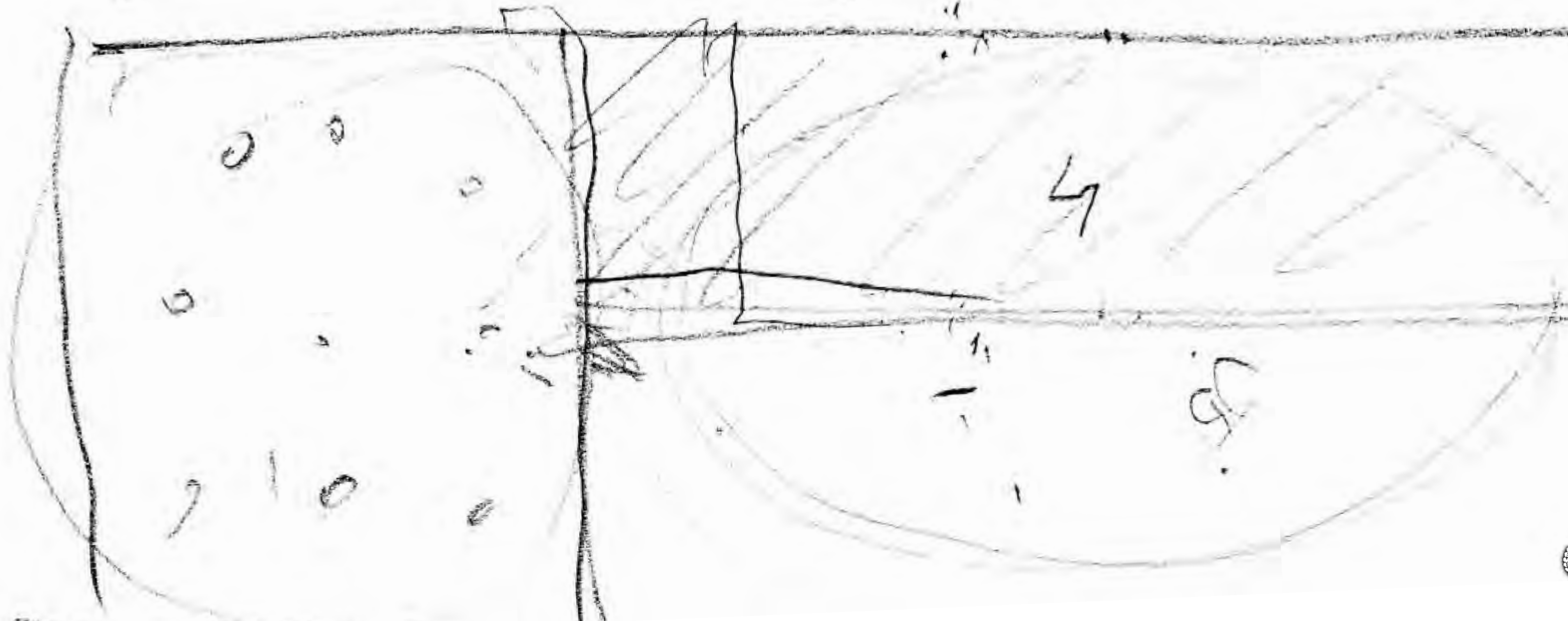
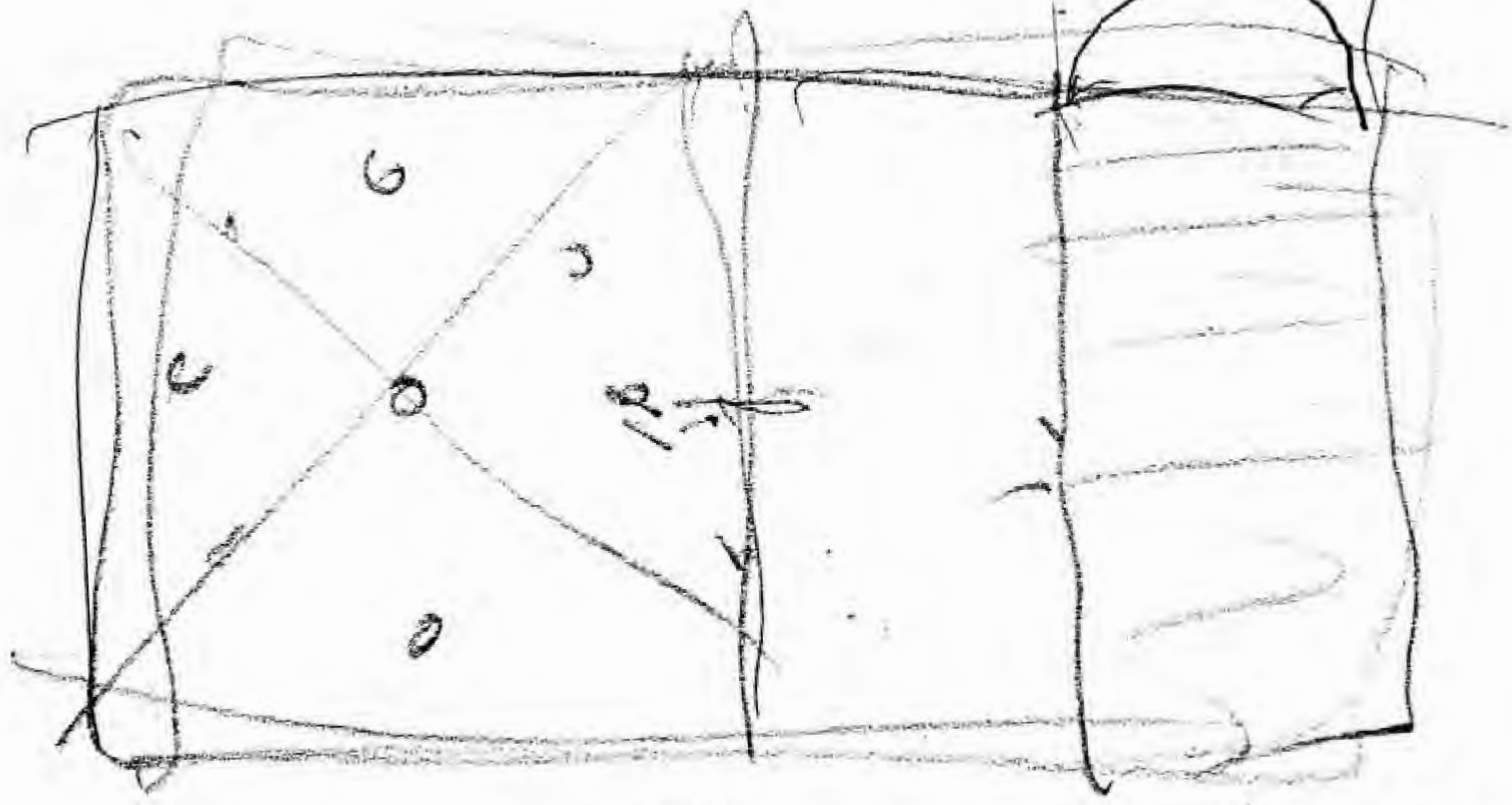
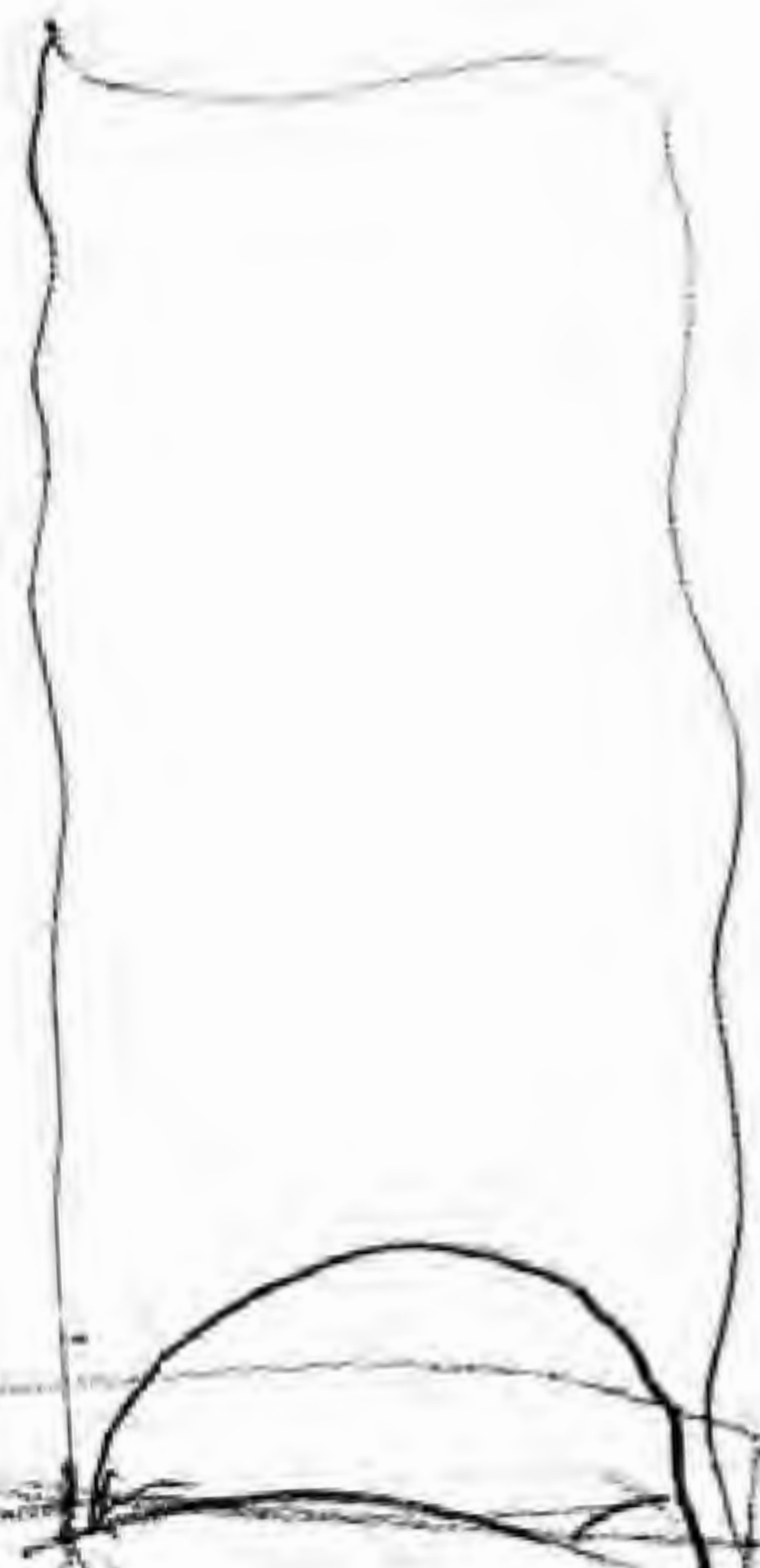
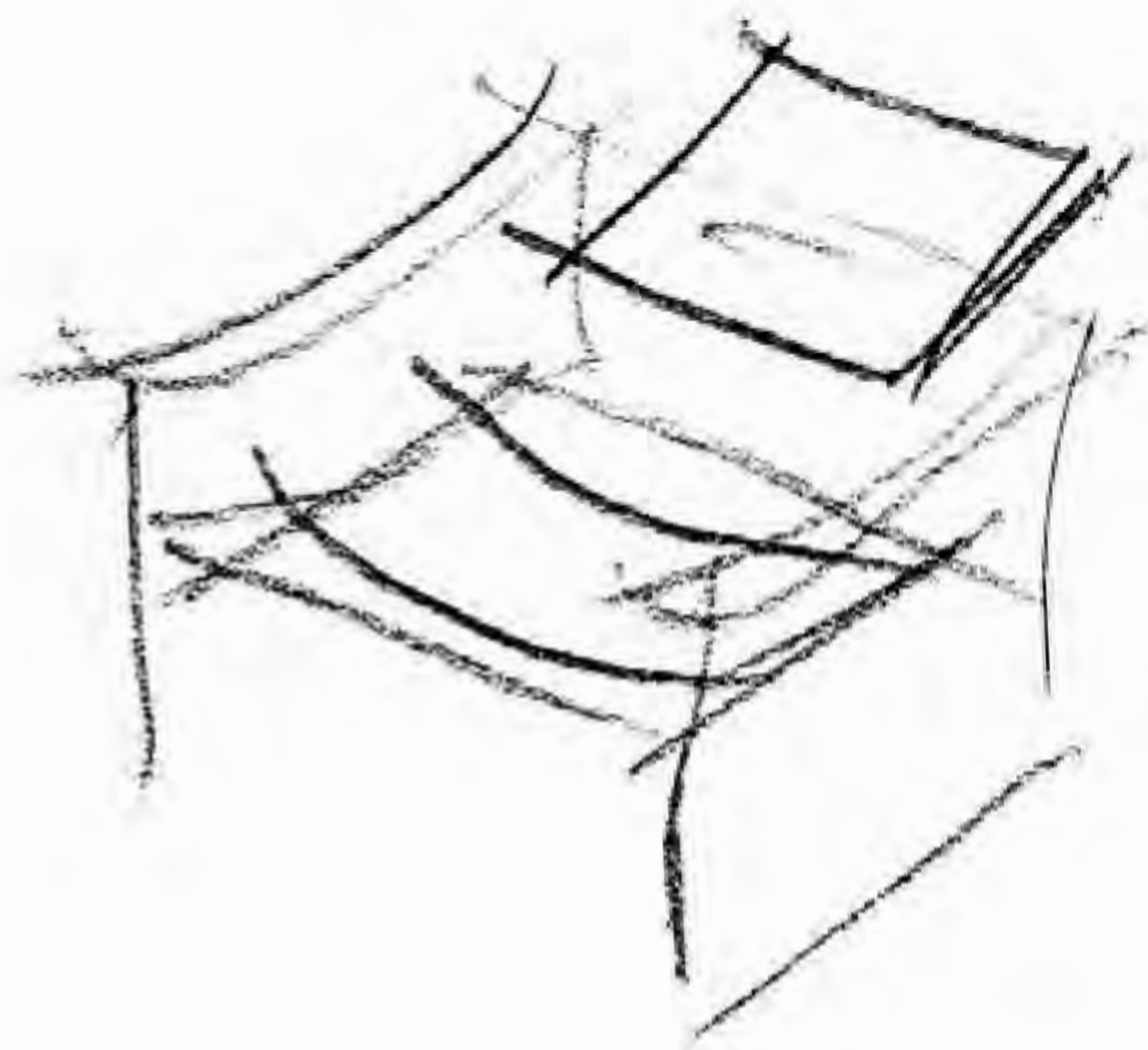

VLADMIR KAGAN

(art.

Richard Buckley)

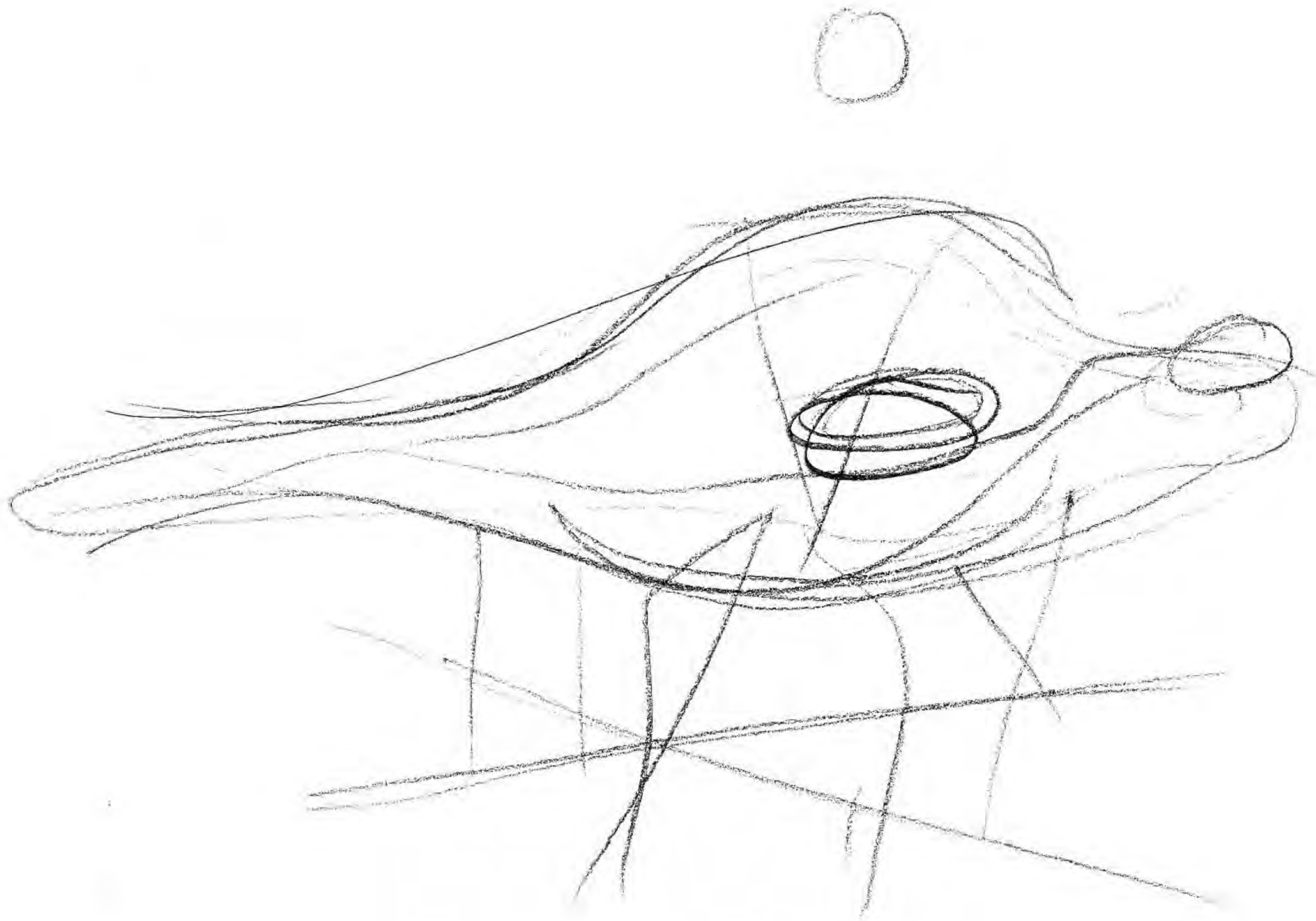

Tom Ford
Chaise longue
by Eames

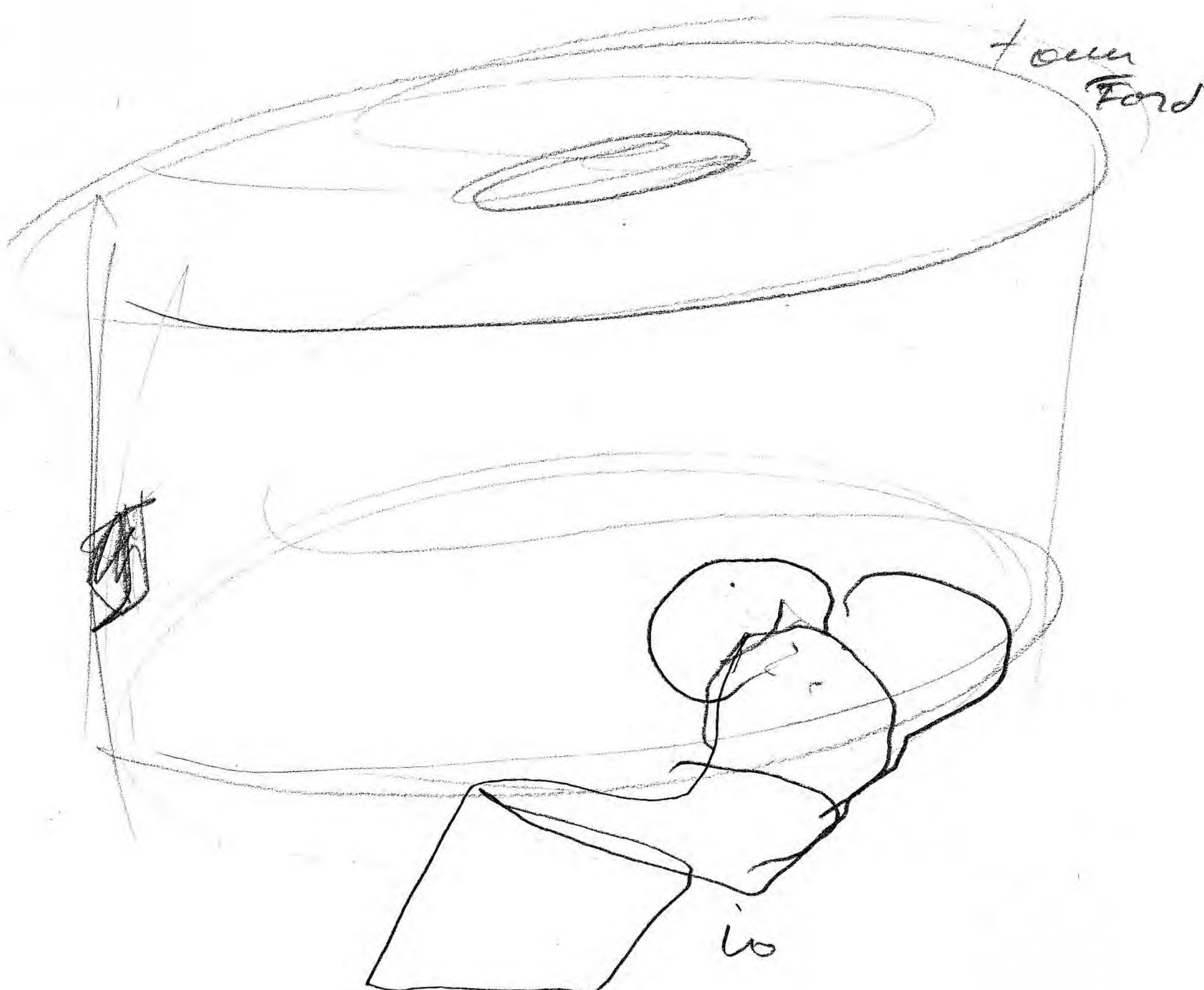

Ford

io

(Calas 815)
2015 *

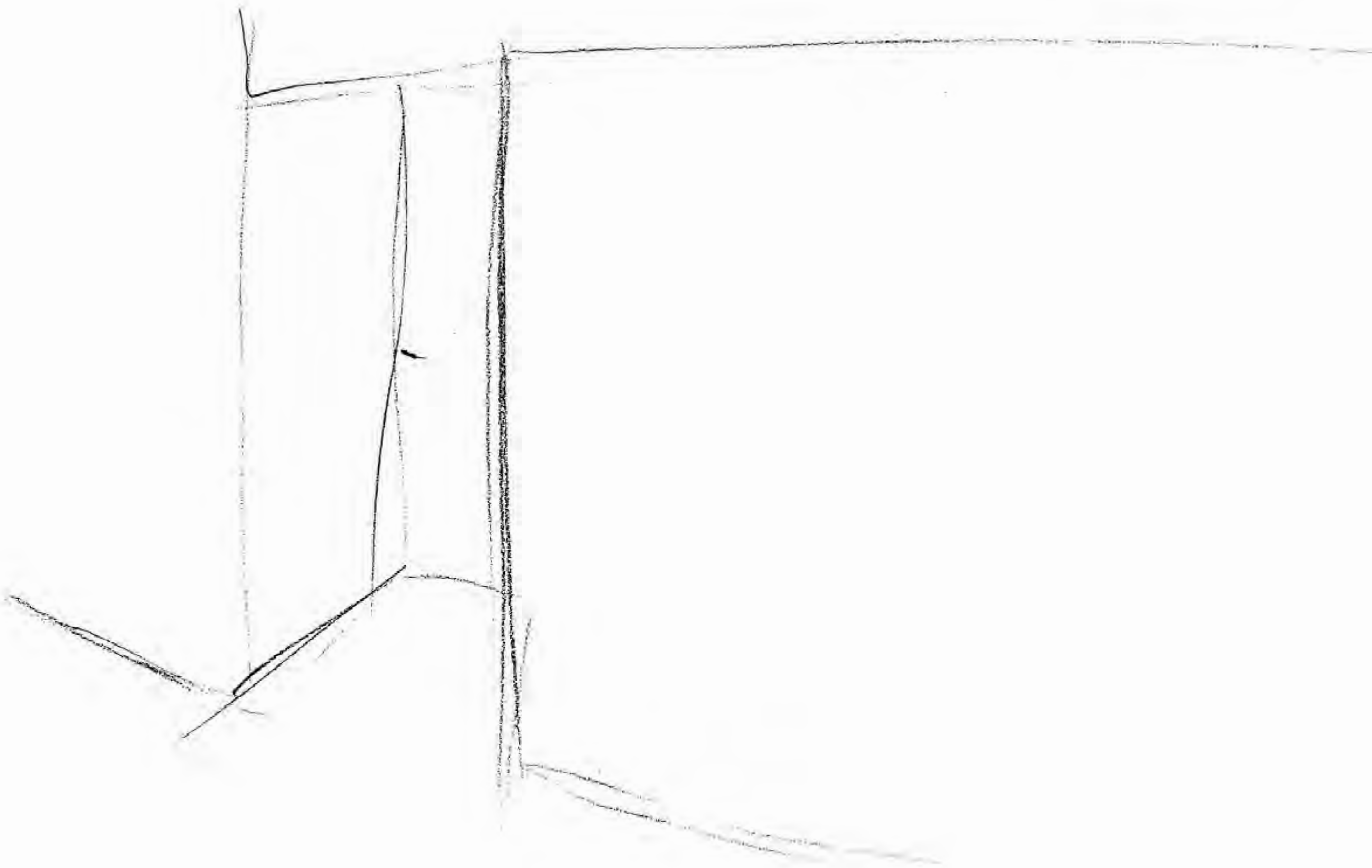

Tom Ford.

Depth holes.



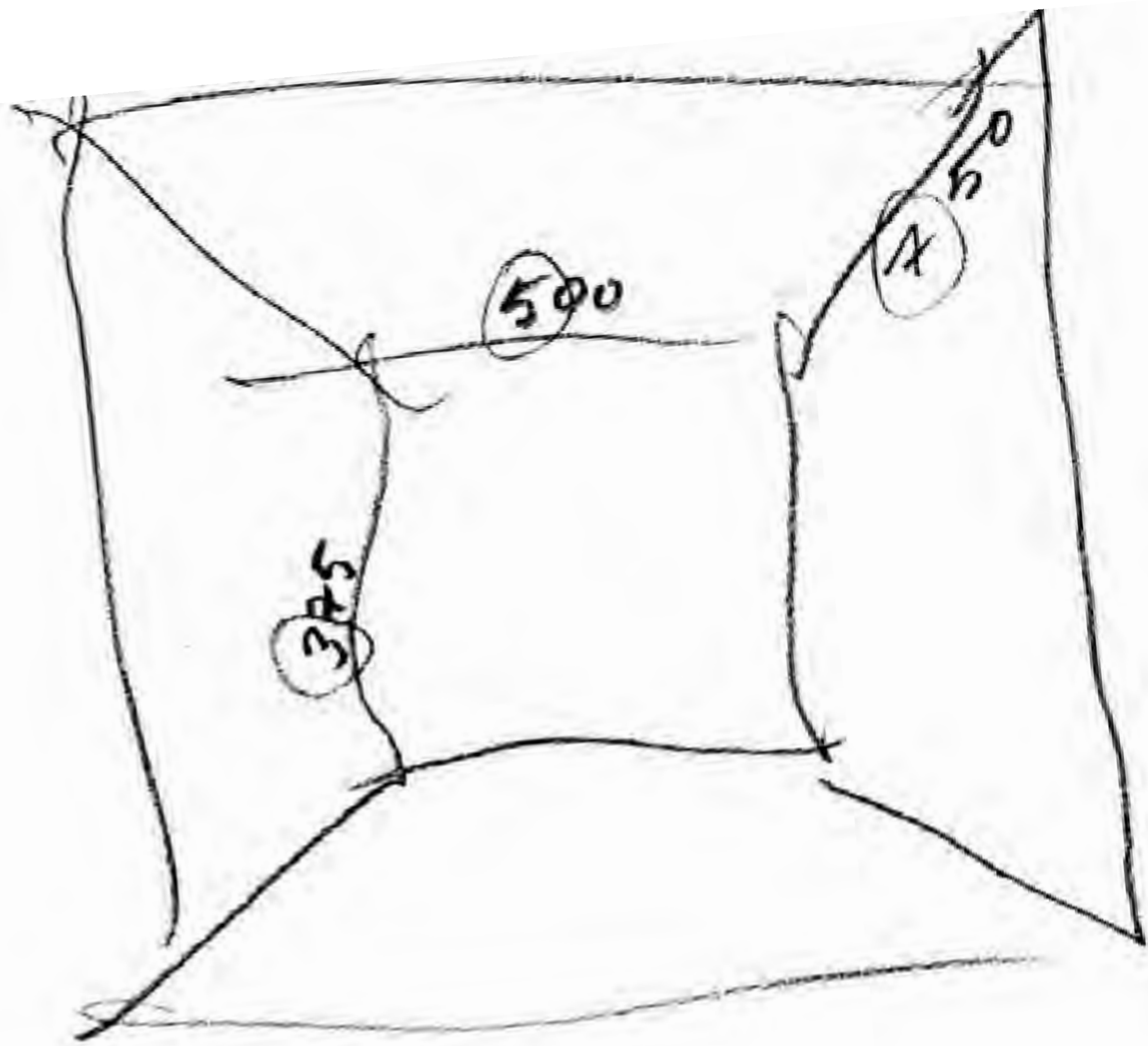

$5 \times 7'64 \times$
 $\times 3'754$

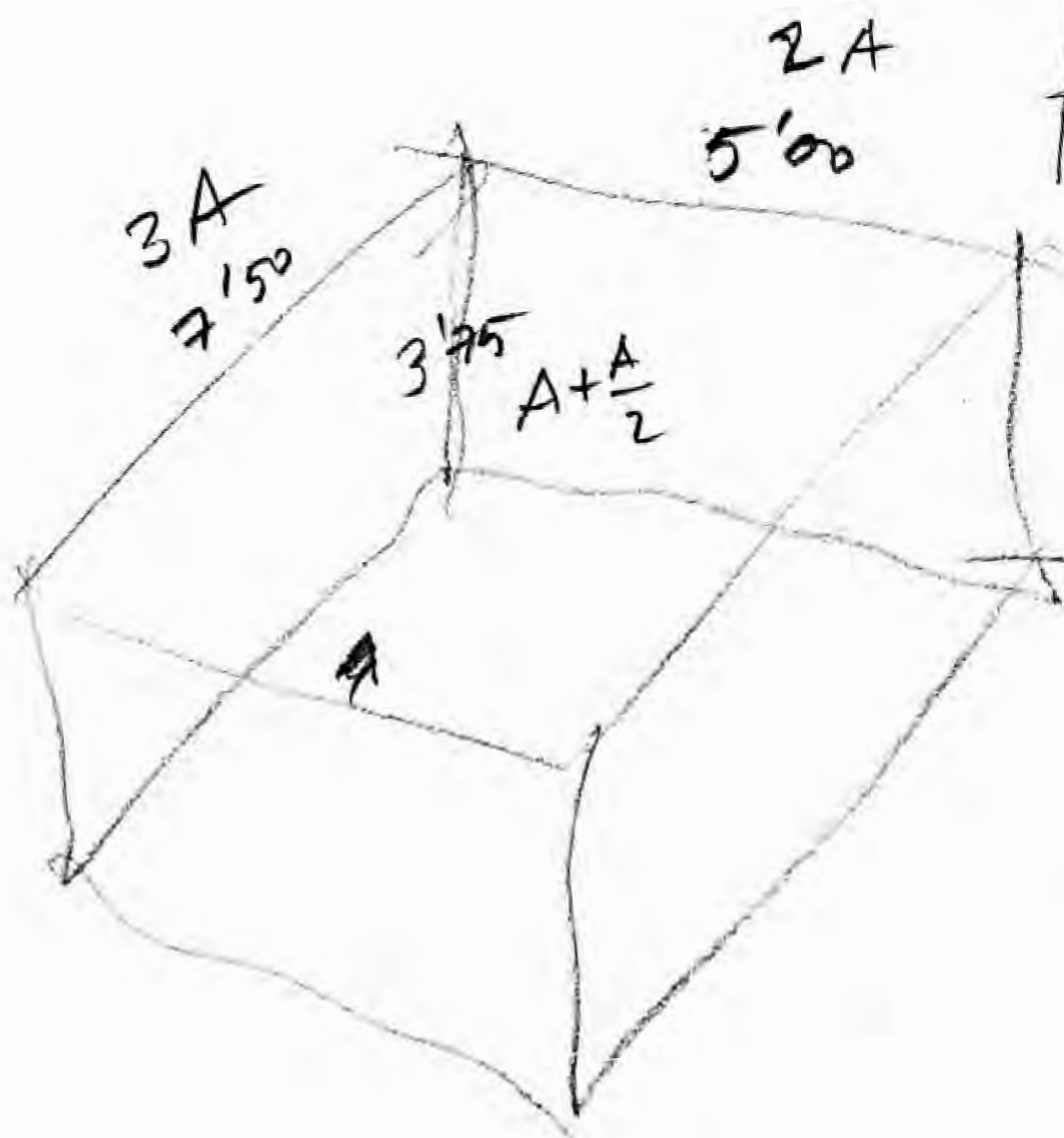
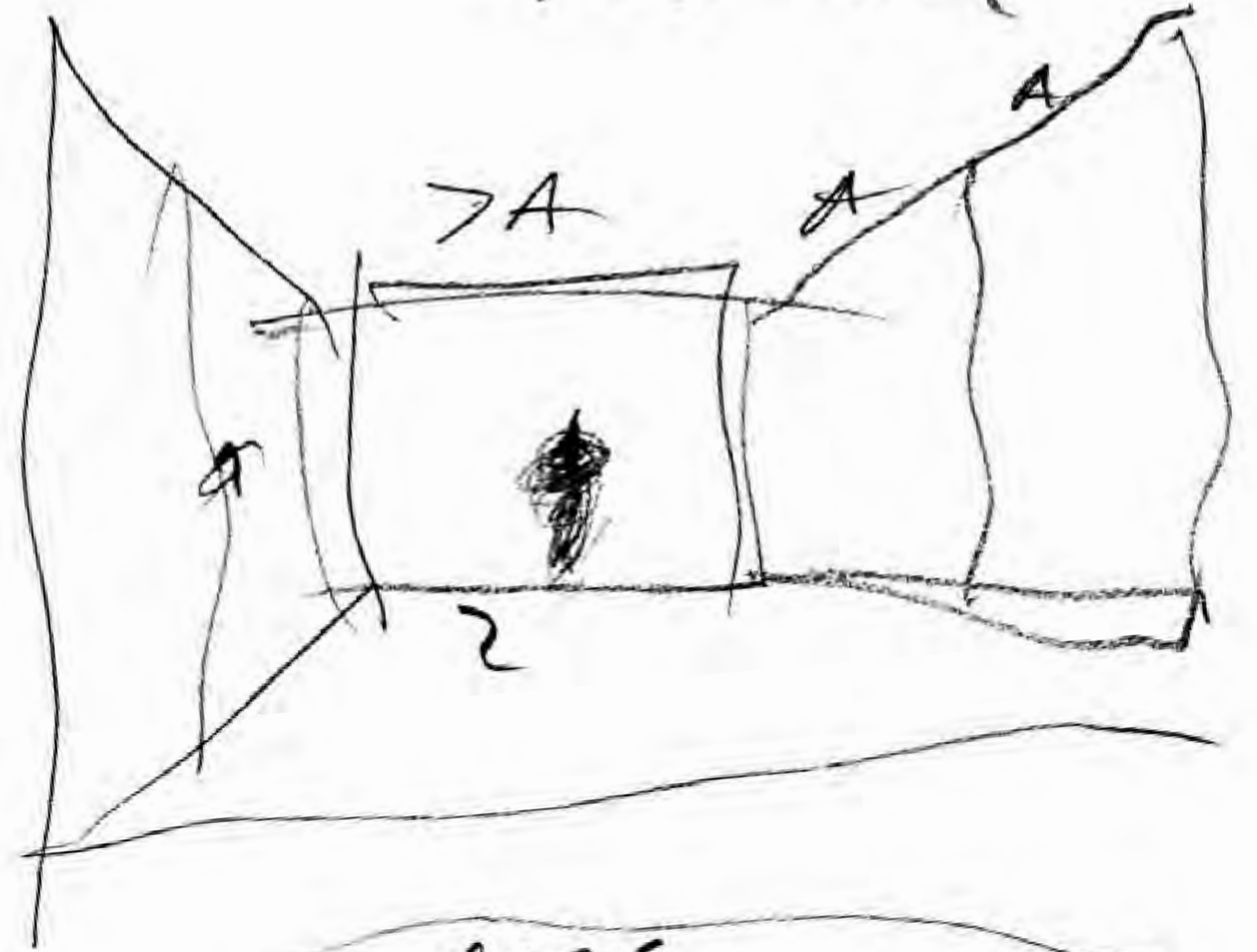

casa
 de
 Michael
 DALE
 Camino Escondido 14
 Santa Fe
 New Mexico USA

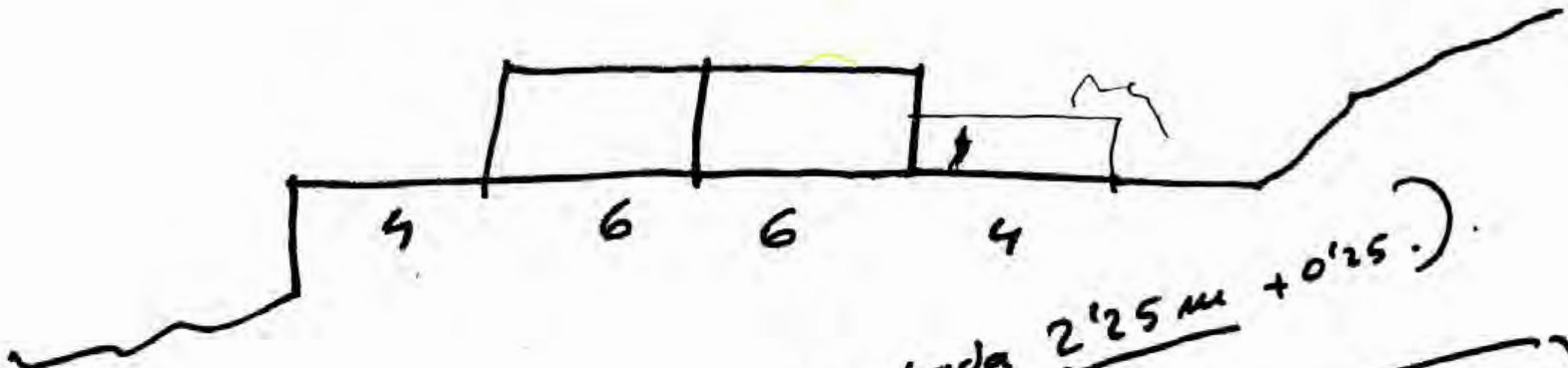
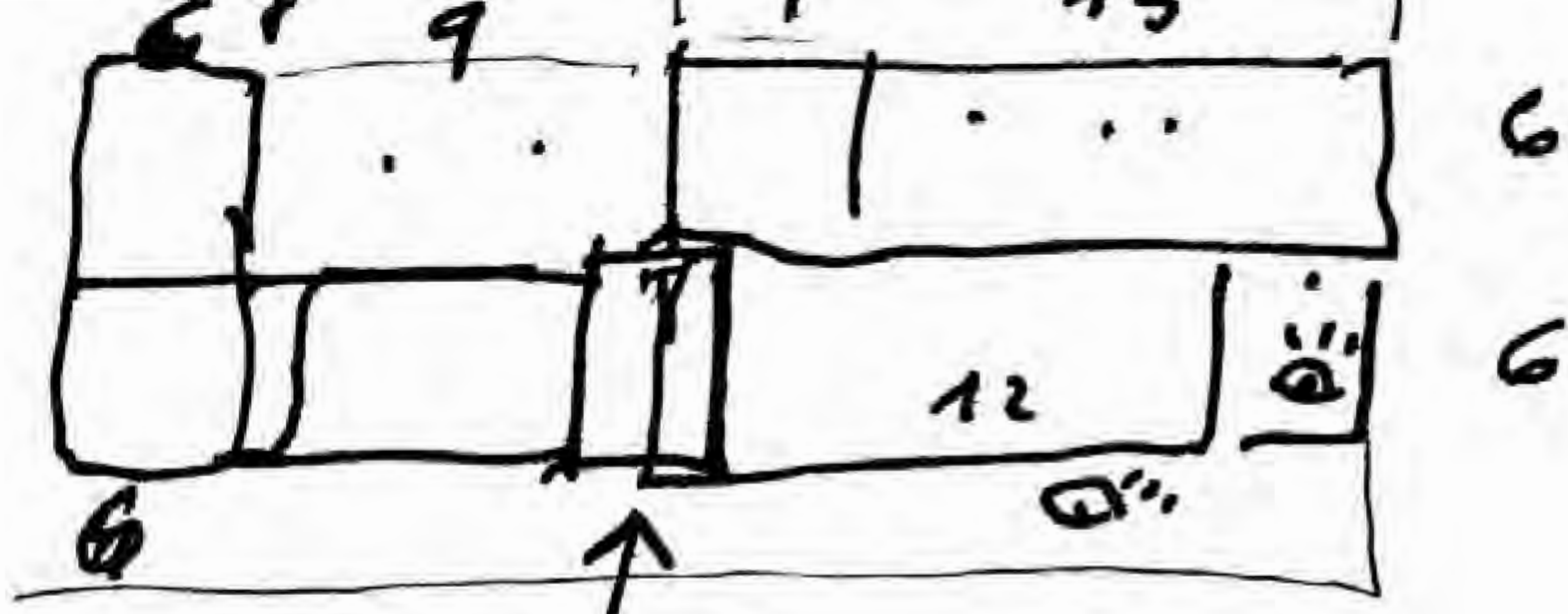

- 1 medir (grosor del muro)
- 2 hacer foto.
- 3 medir incruvados

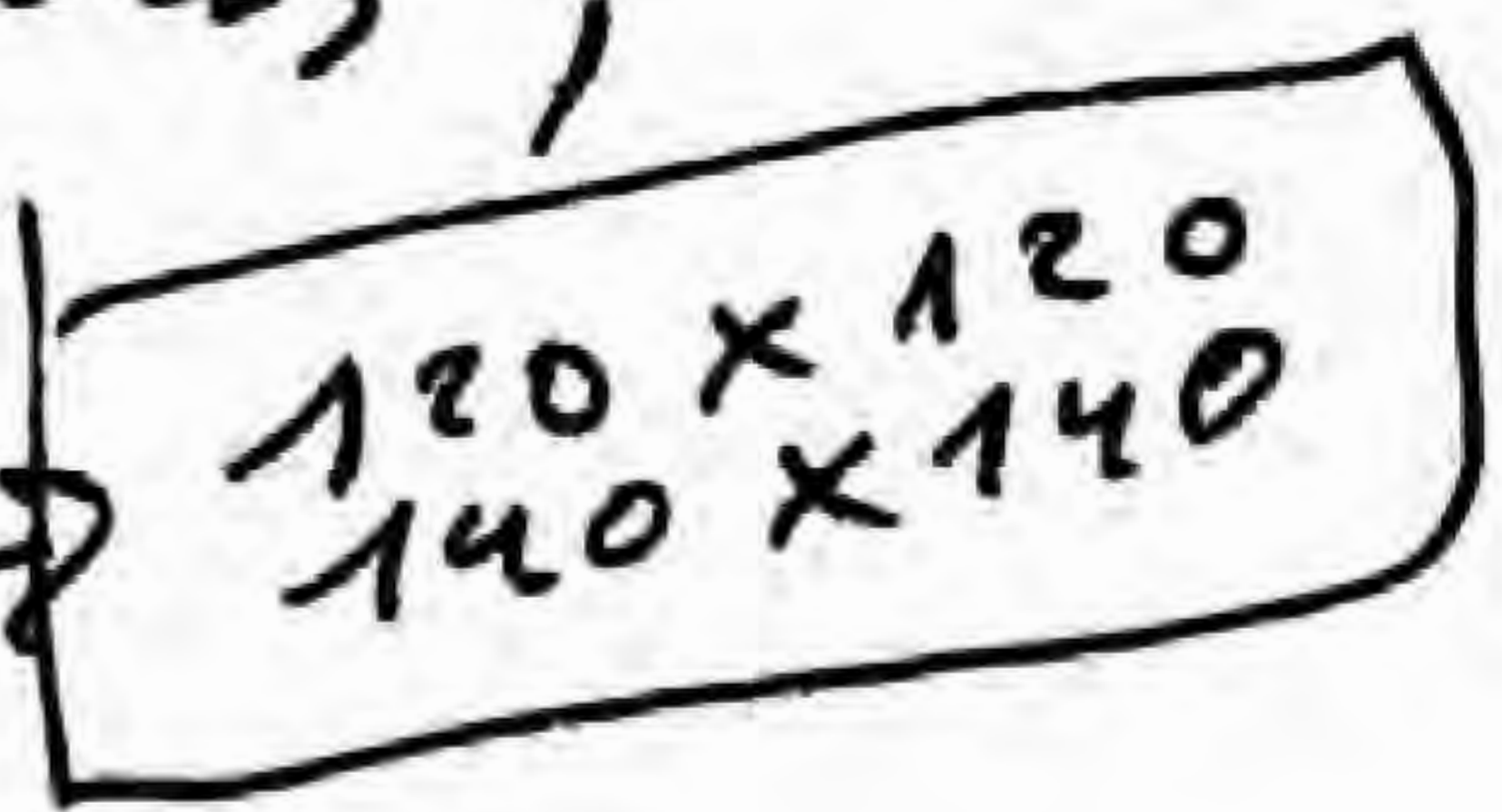

4 preguntar a Tom Tamaño de Pavilion - Summer write.

5 Fireplace!
en todos los paviliones

8 6 4
4 3 2
12 9 1



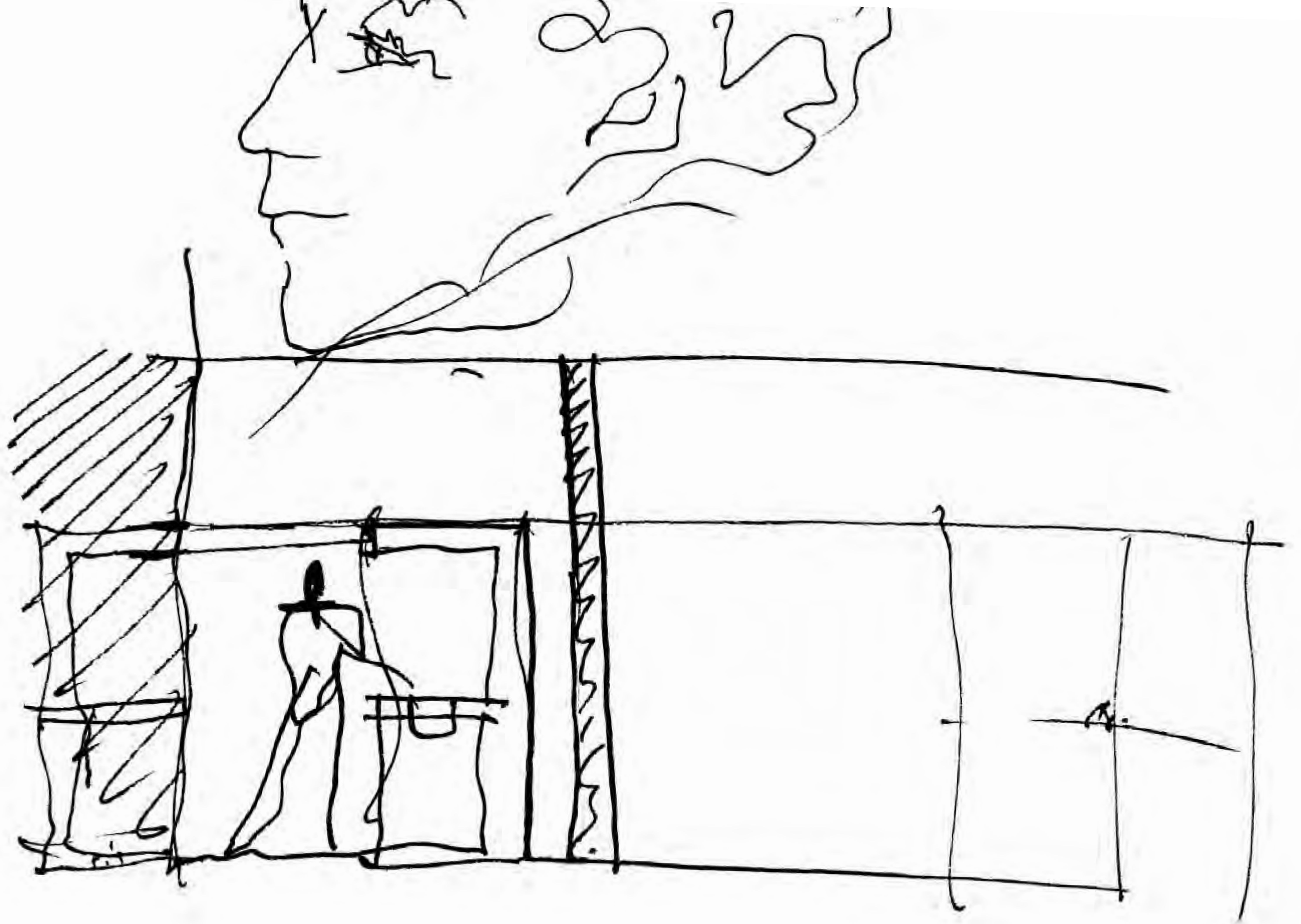

Madrid

le 12 d'octobre de 1996

— avant le vol vers PARIS.
pour rencontrer Tomford et
parler sur les dernières solutions
pour la maison à Santa Fe.

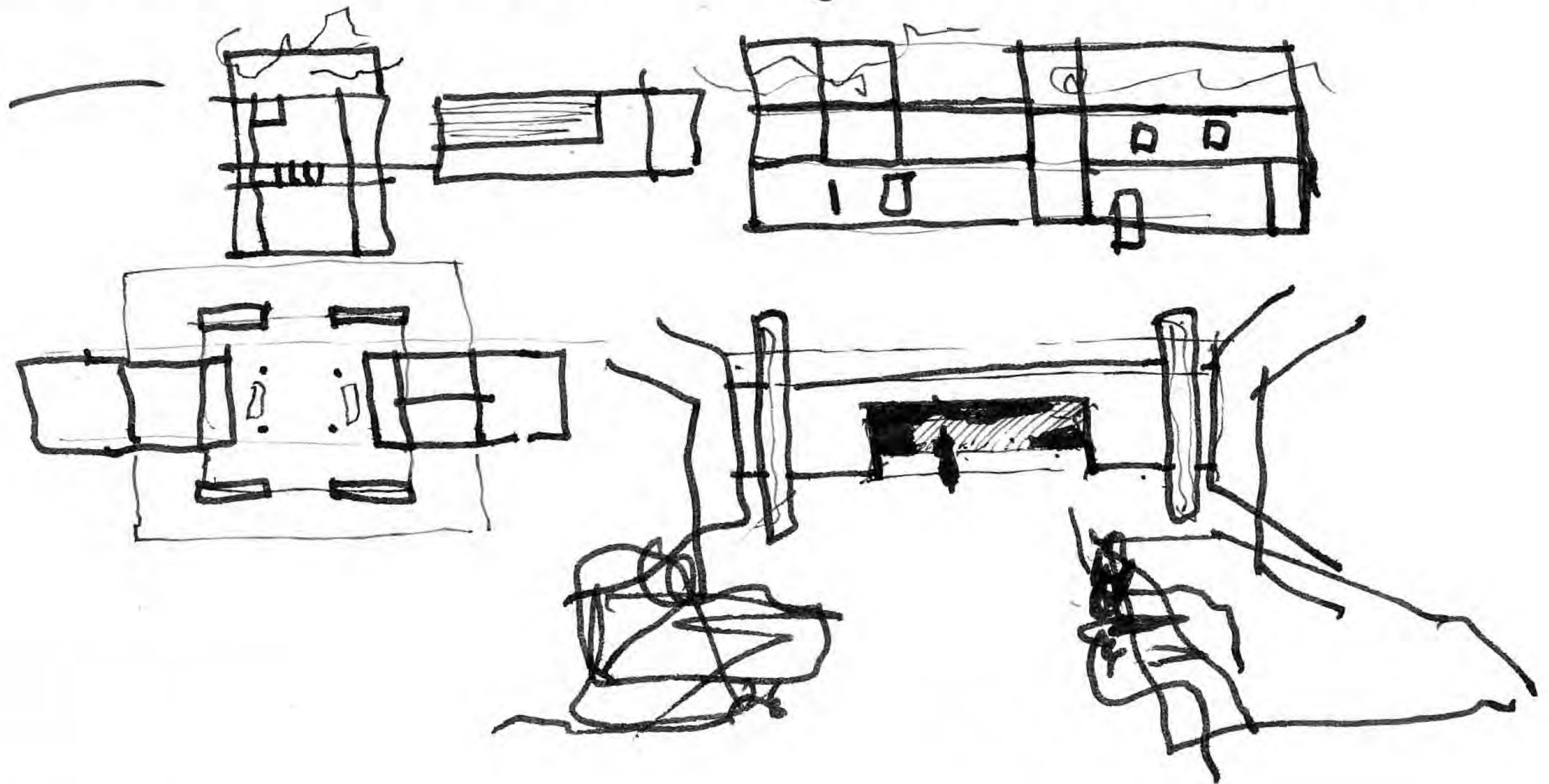

— nous devons concrétiser pour
avancer.

Aujourd'hui le 14 d'octobre de 1996.

S. a. d. je suis très, très, et ne puis
mais que dire grâce, parce que tout
va stupéfaitement. Tanto en lo
personal como en lo docente como en
el trabajo ✓.

House for Tom Ford.
Resumen de indicaciones de ayer:
Vertical house.

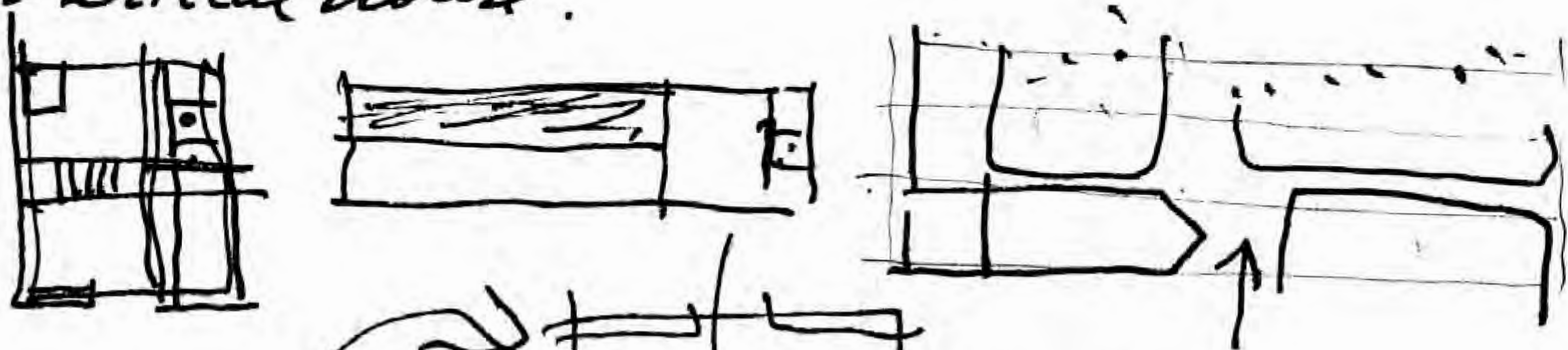

VH

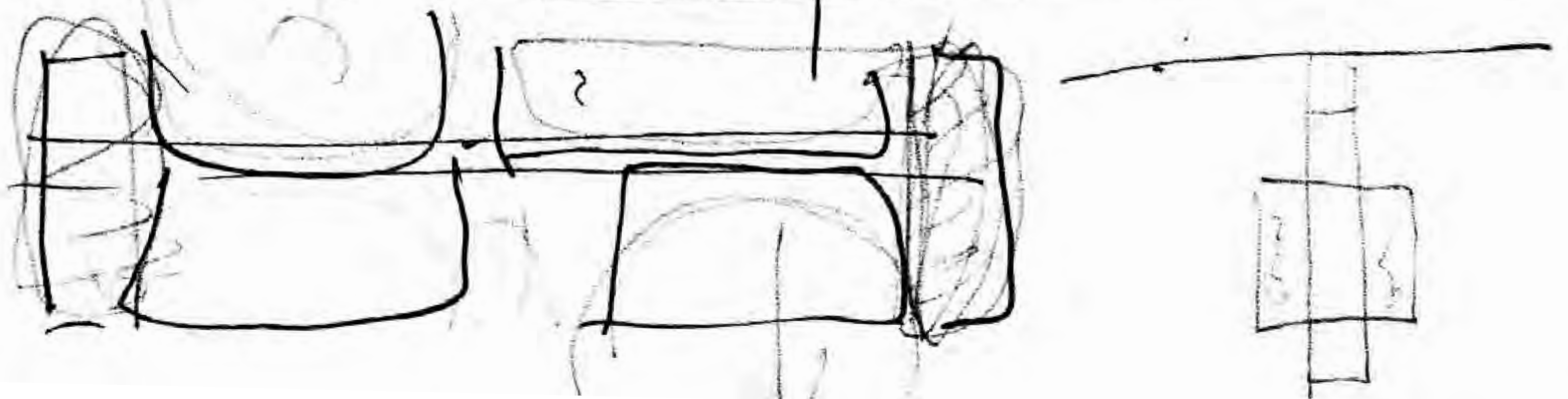
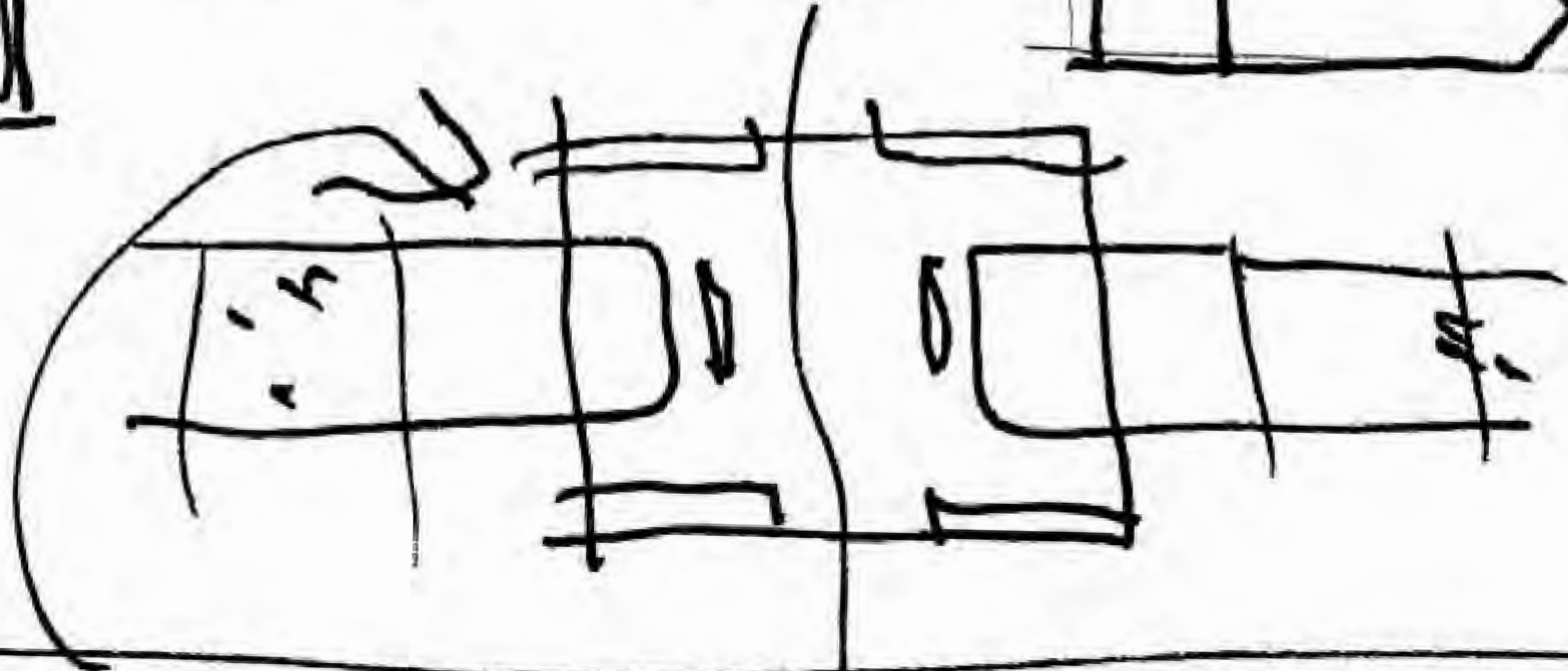

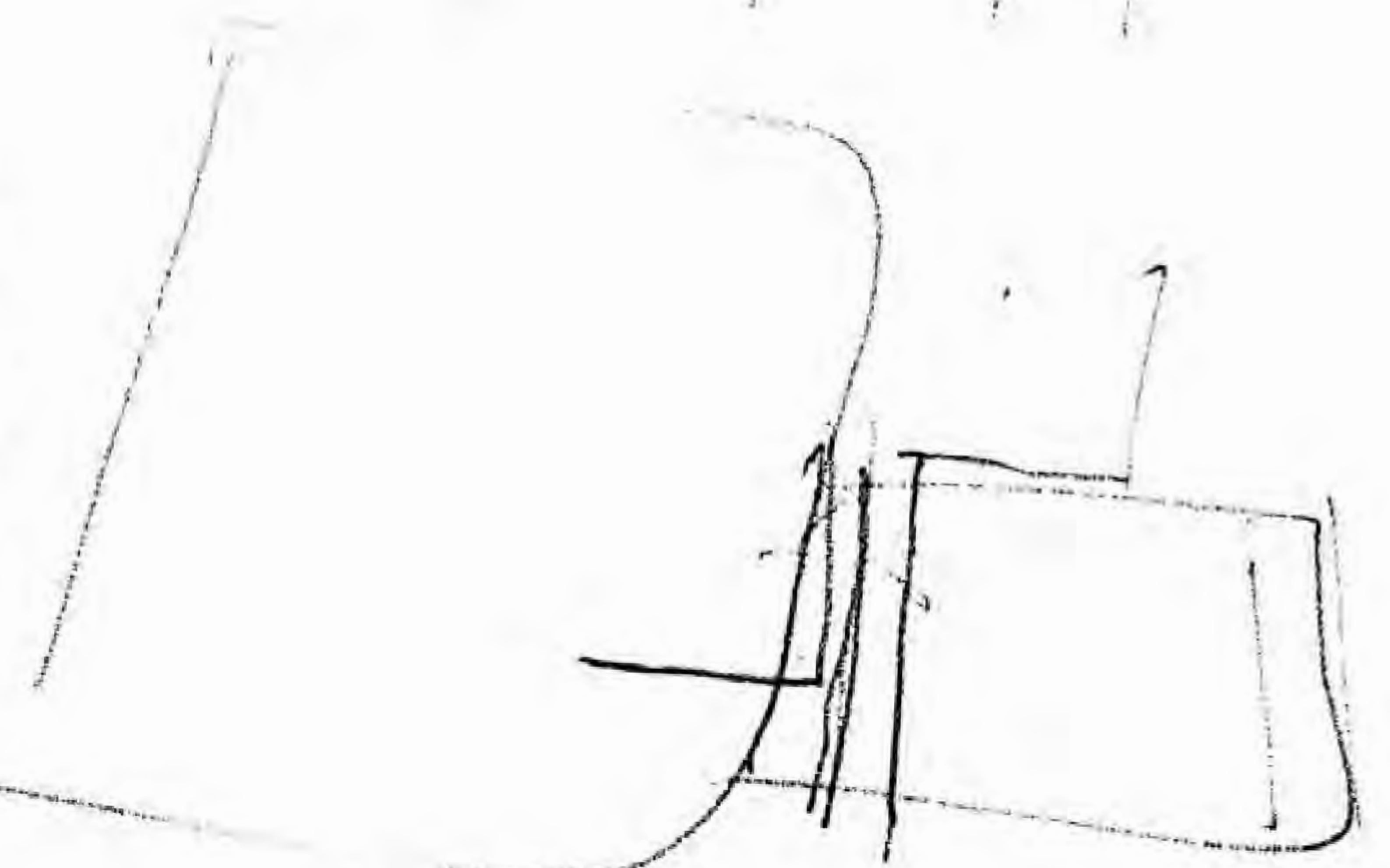
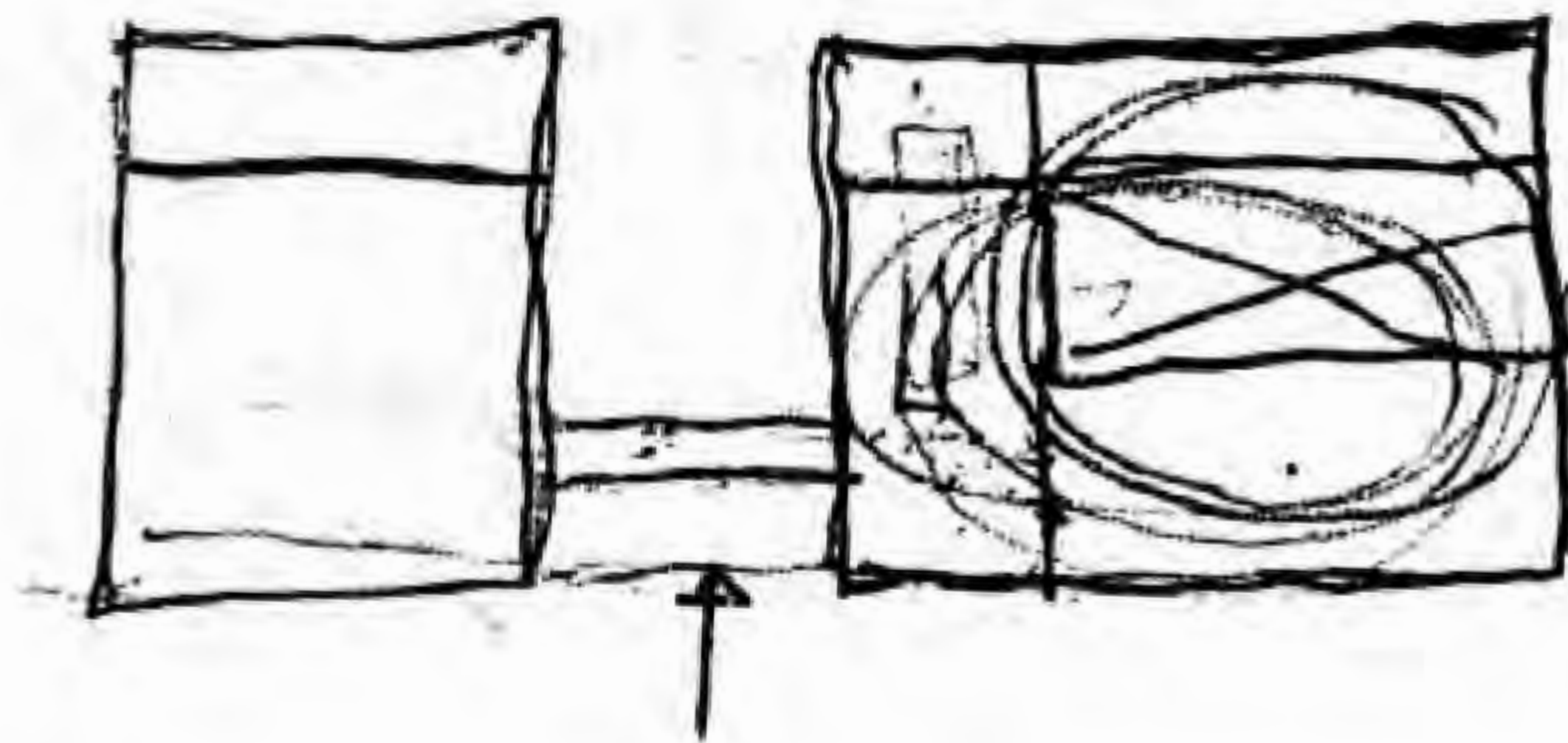
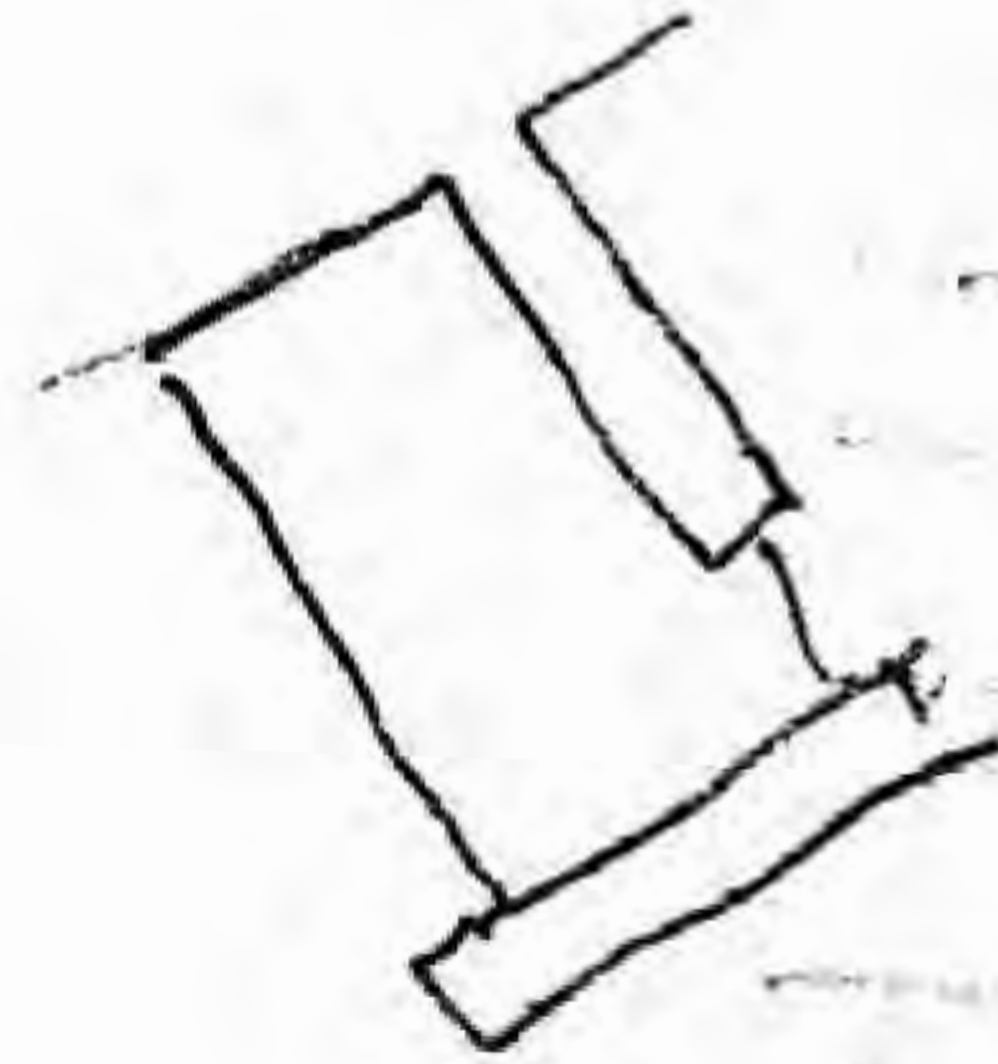
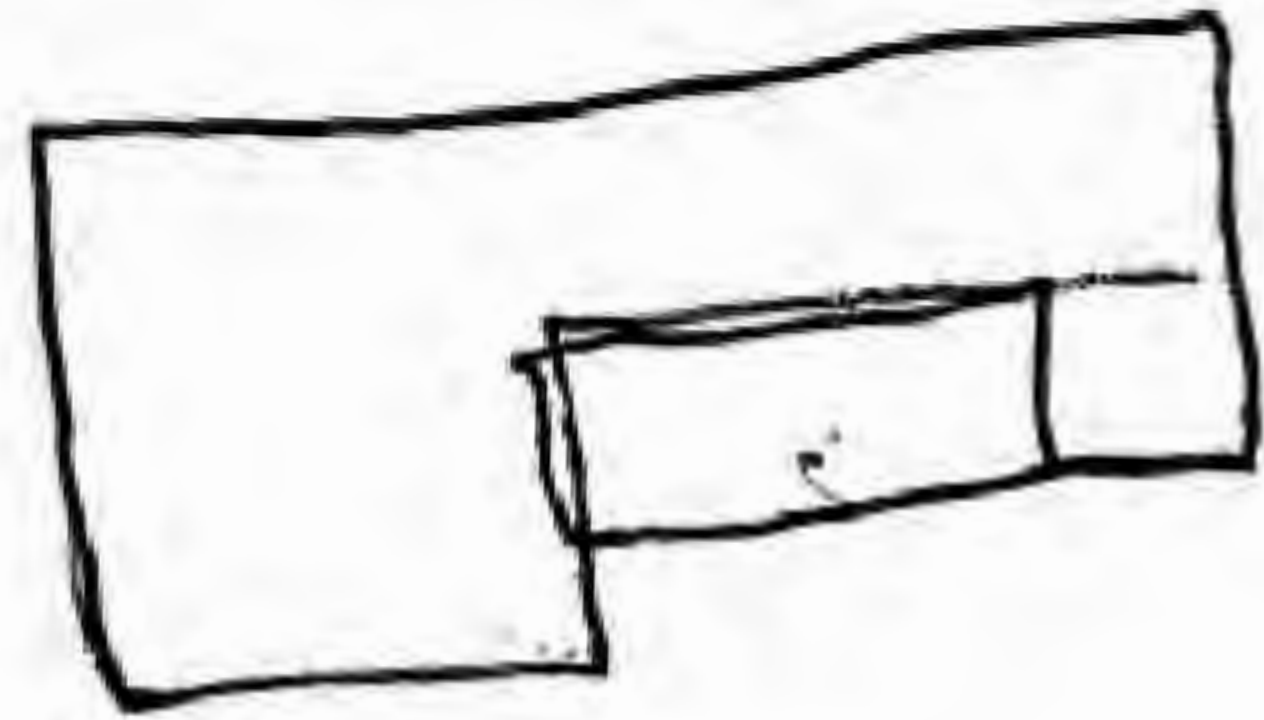
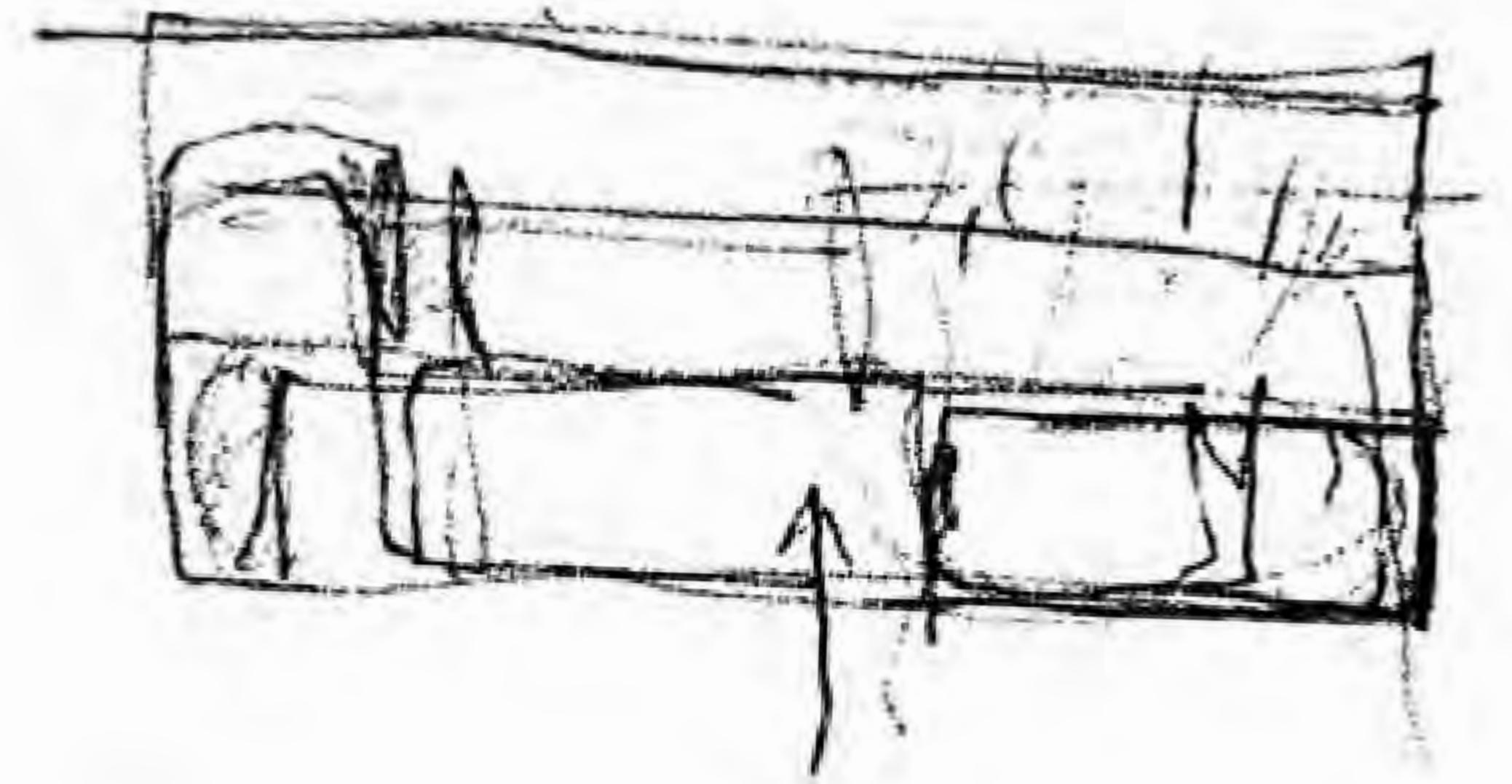
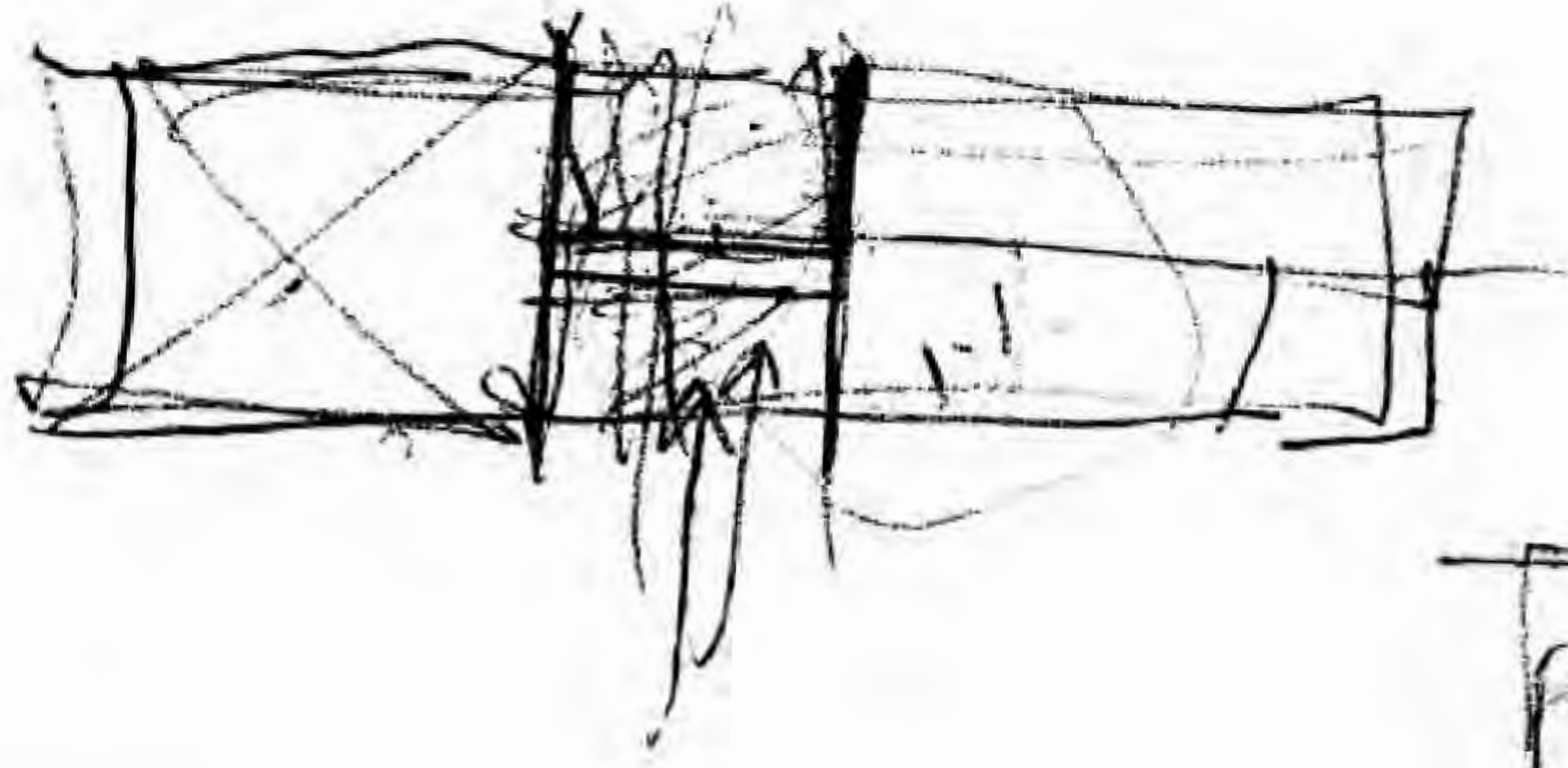

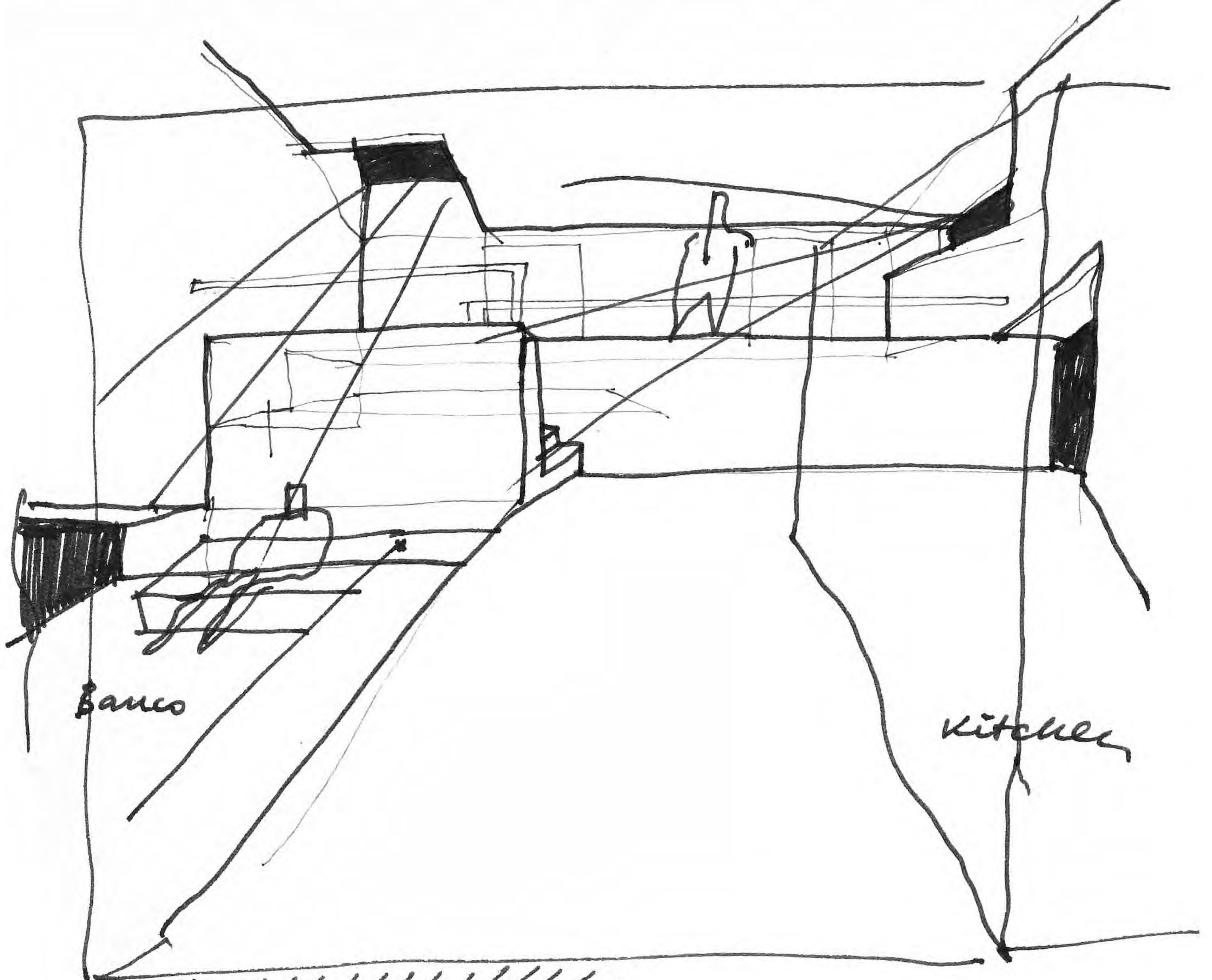

Banco

Kitchen

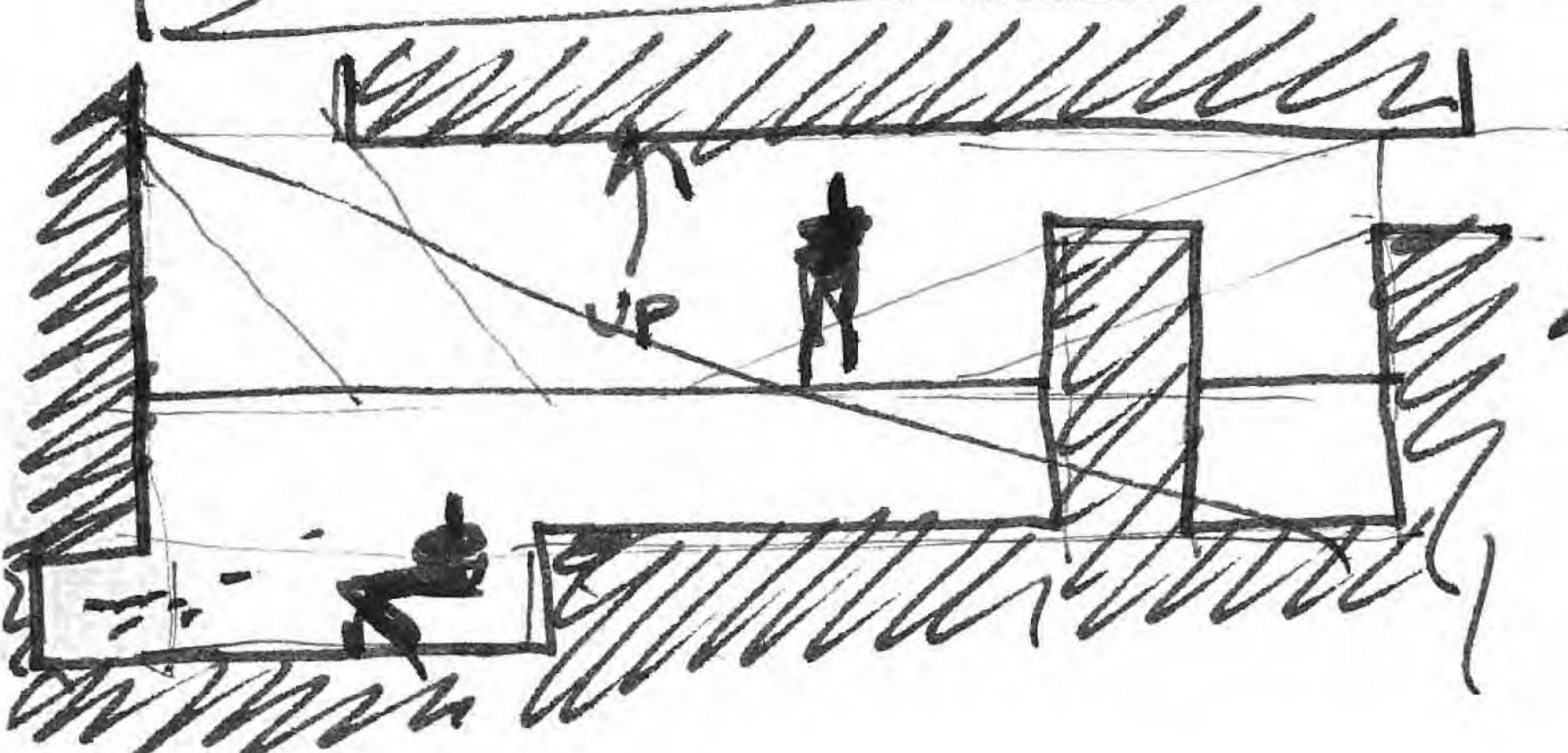

UP

MM
March 10, 1997.

two, vomibilitie, (fireplace - banco)

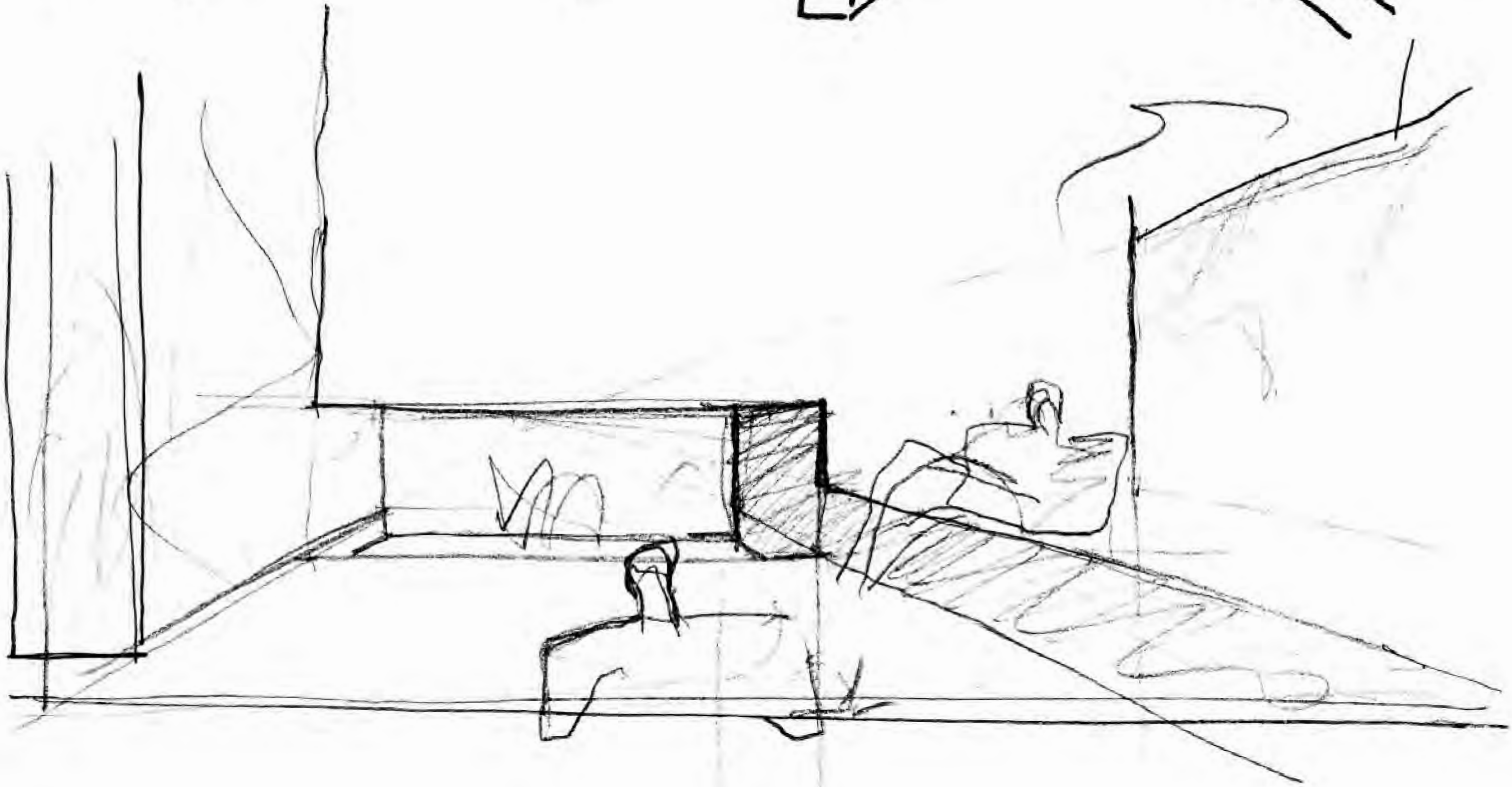
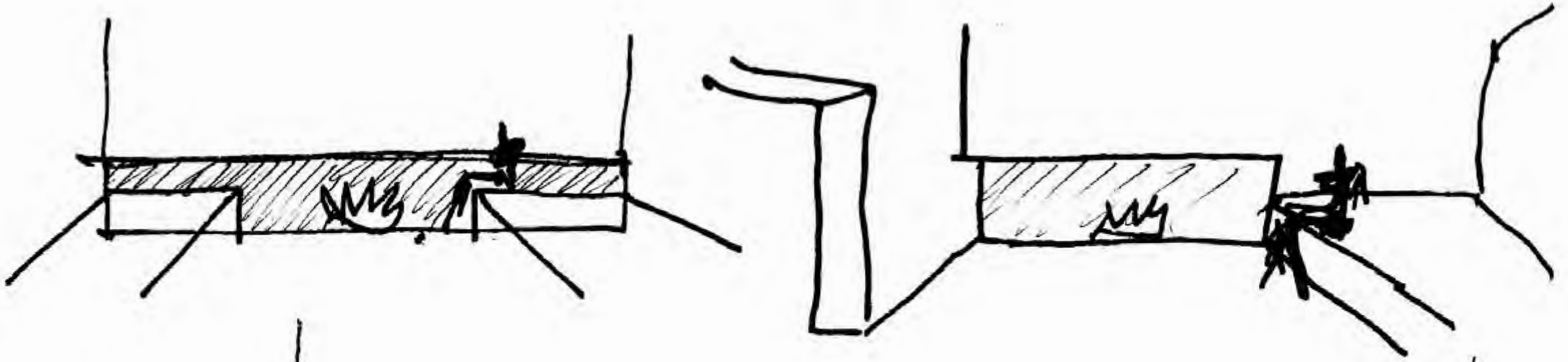

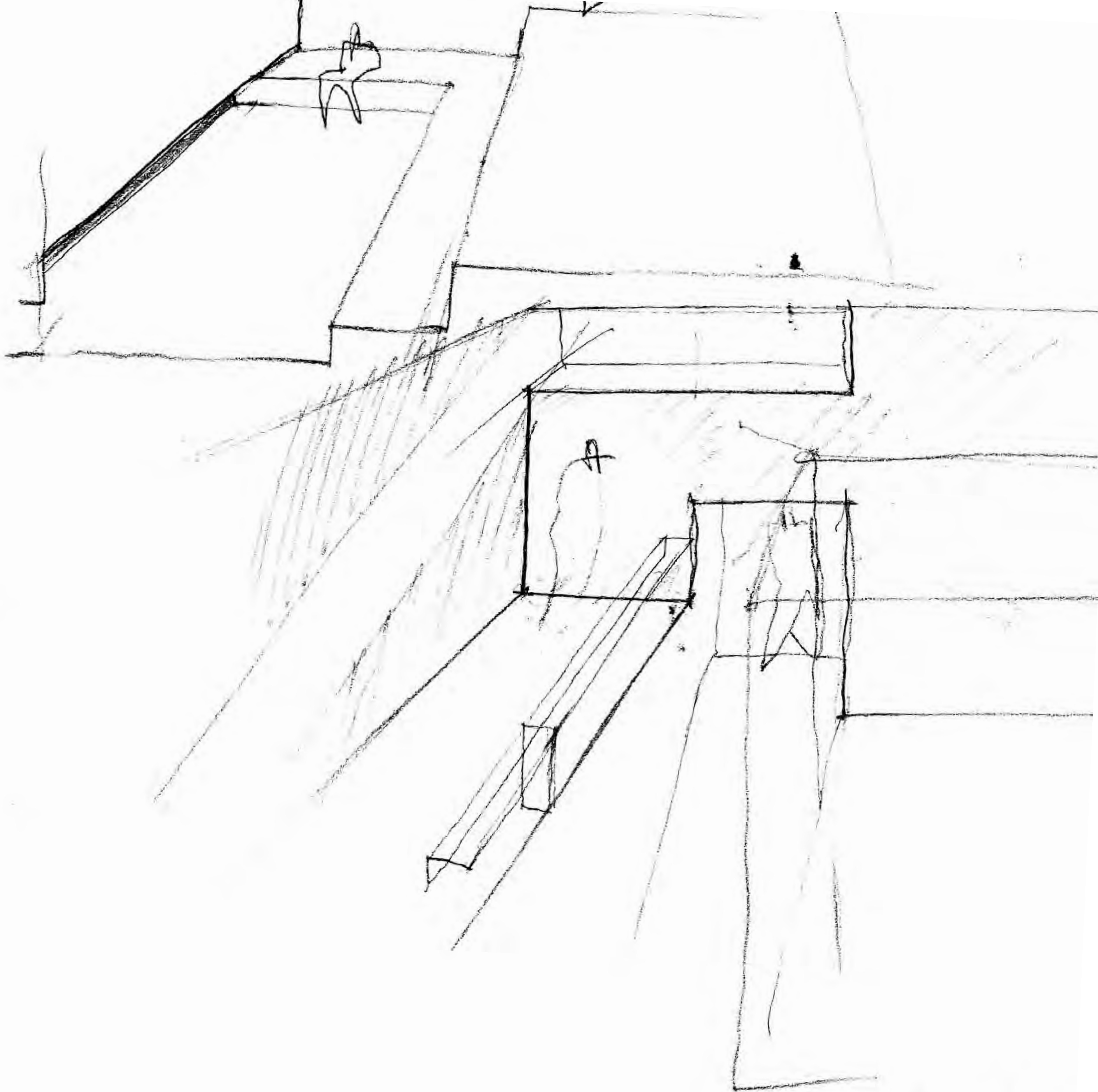

March 10, 1992

main house. / living room.

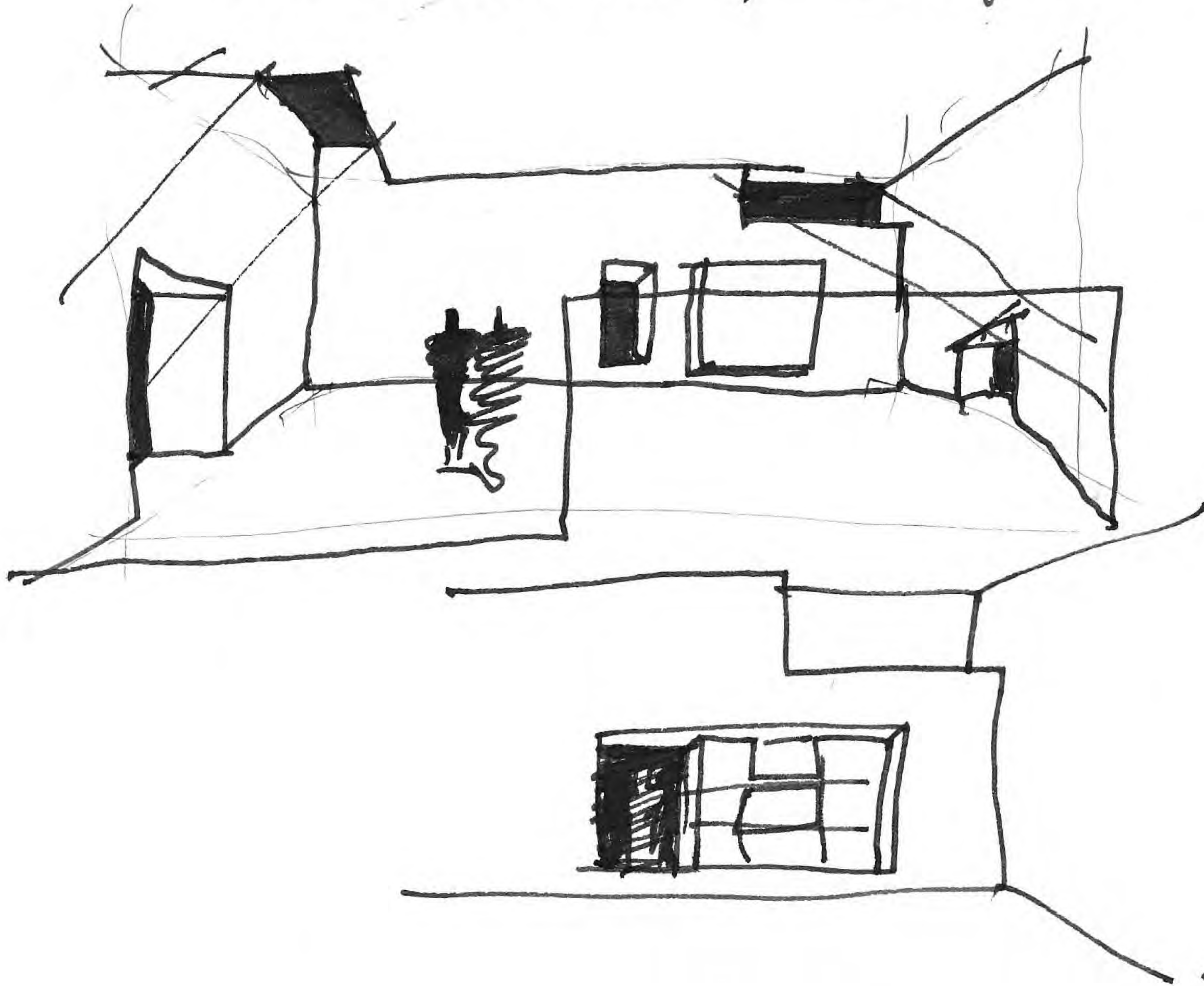

WJ.
March 10 92

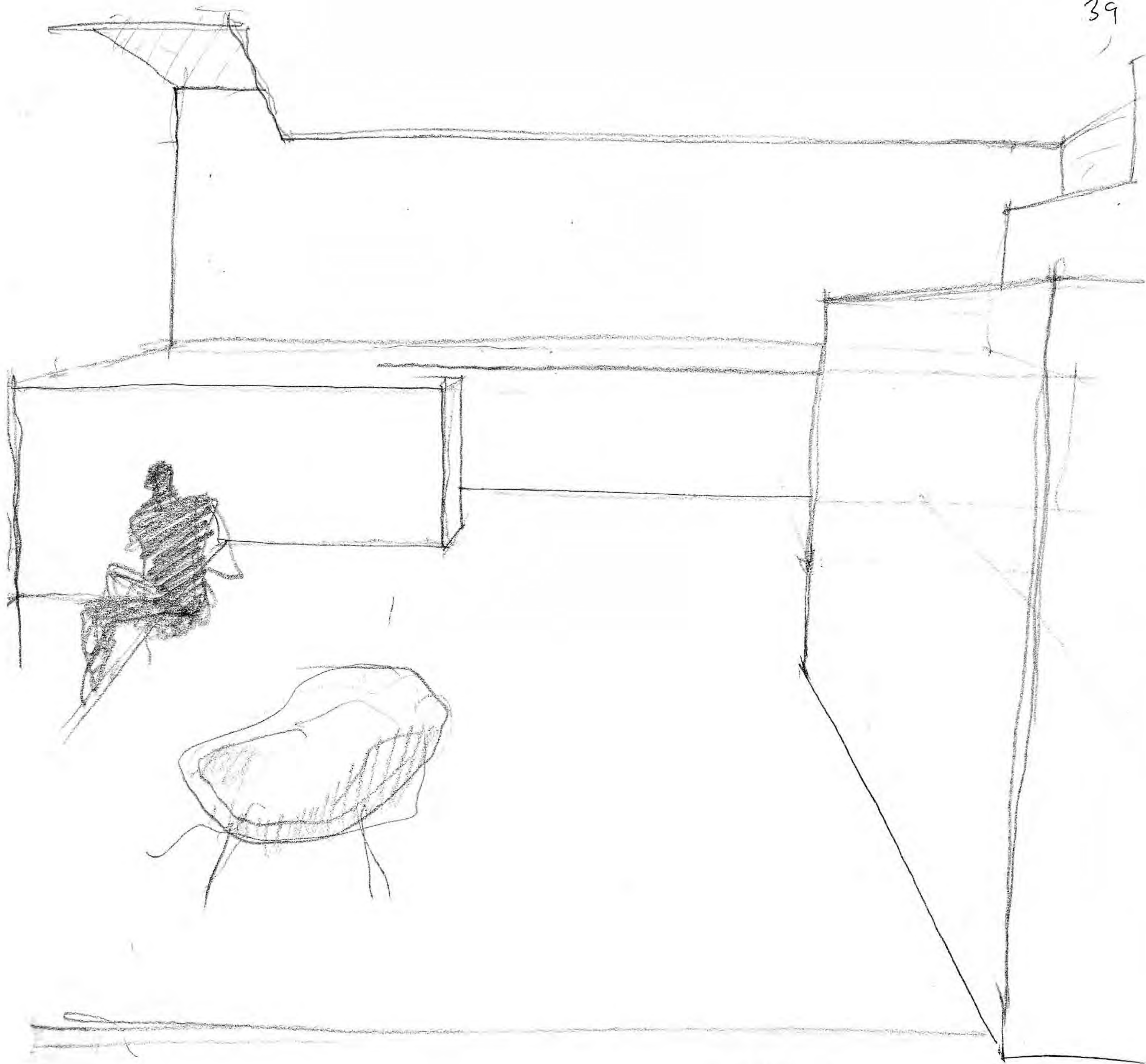

My
March 15 1997

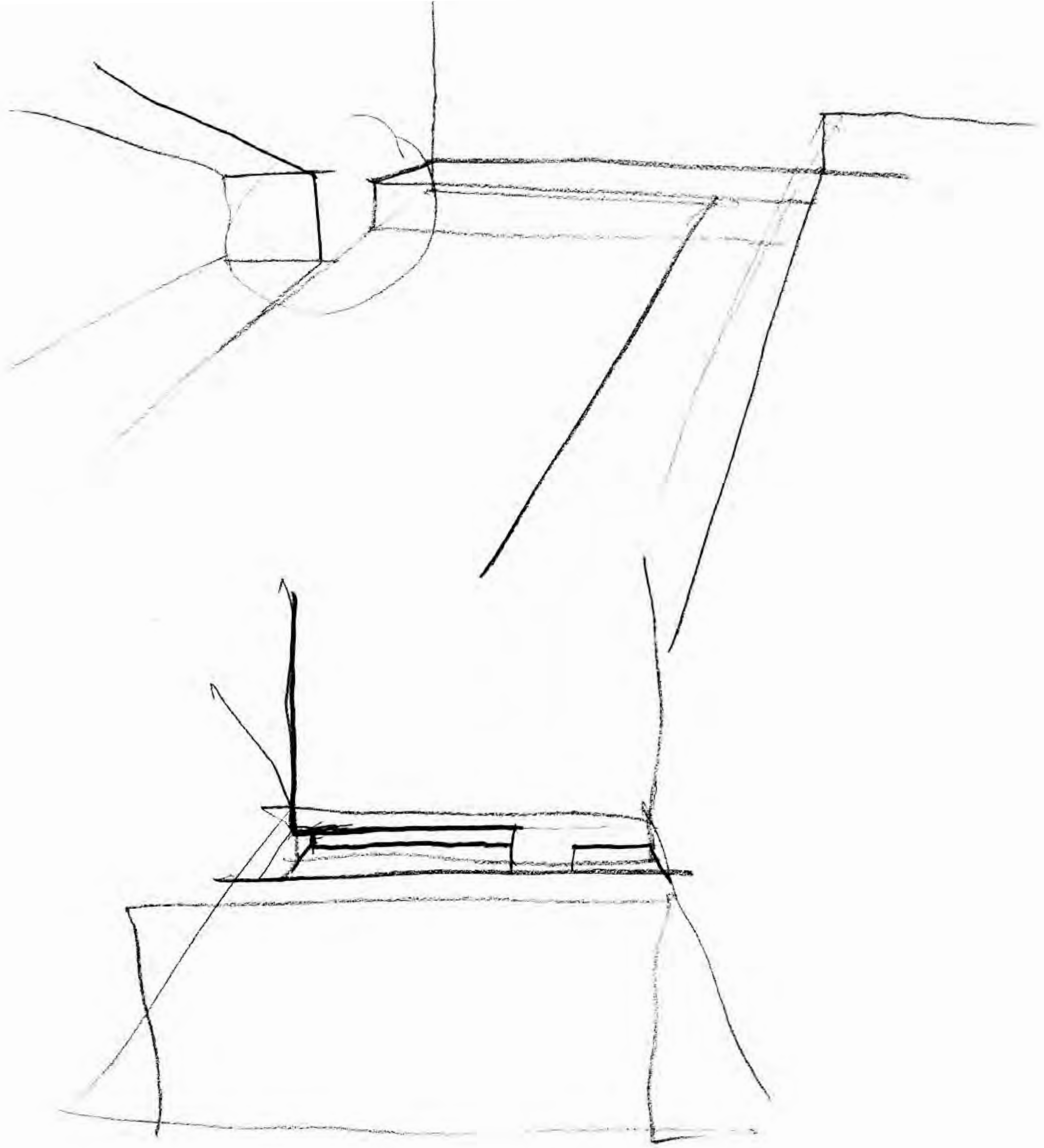

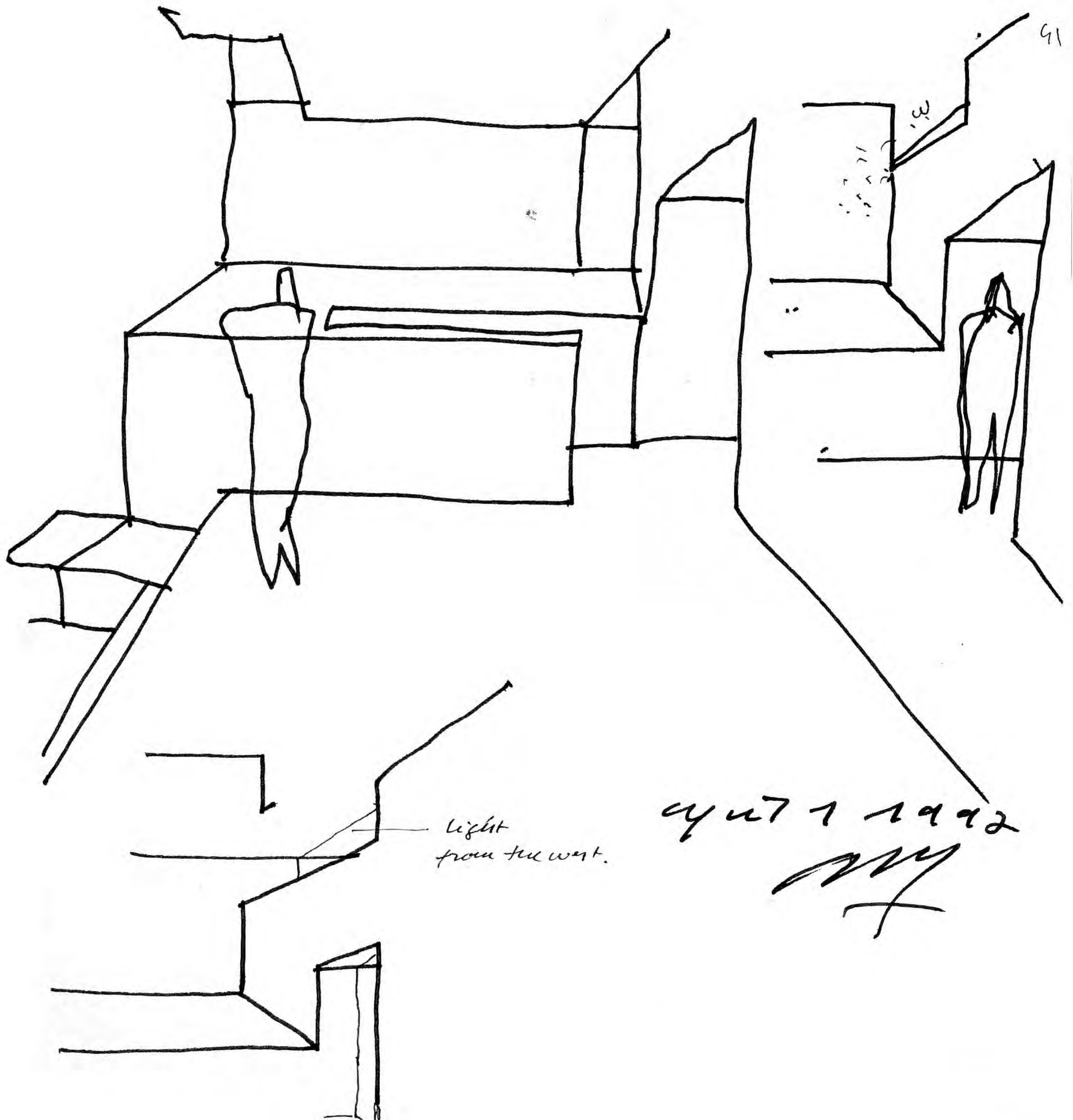

91

31

light
from the west.

April 1 1992
[Signature]

puerta al calor etc

puerta incendio

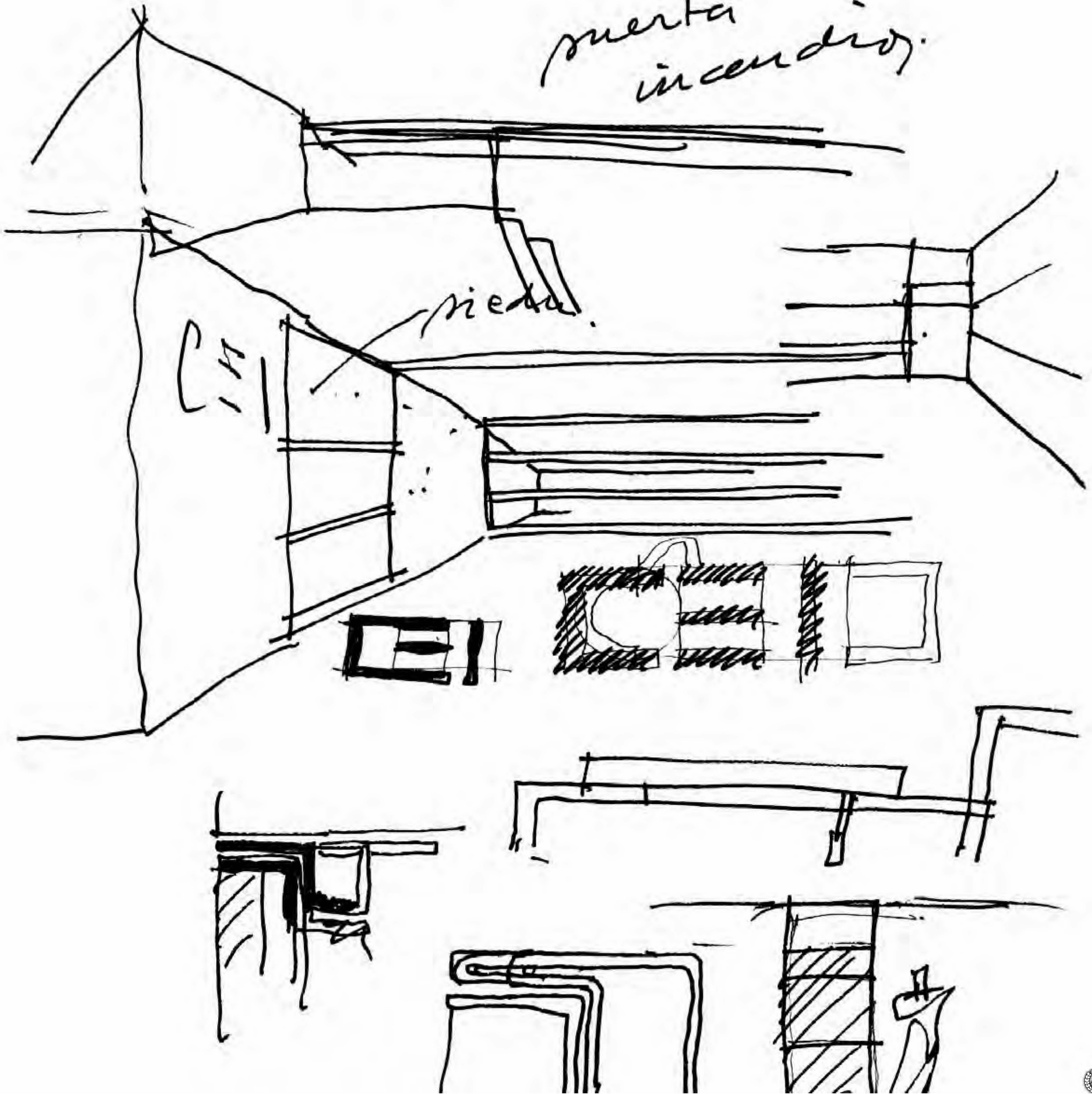

ALM
47

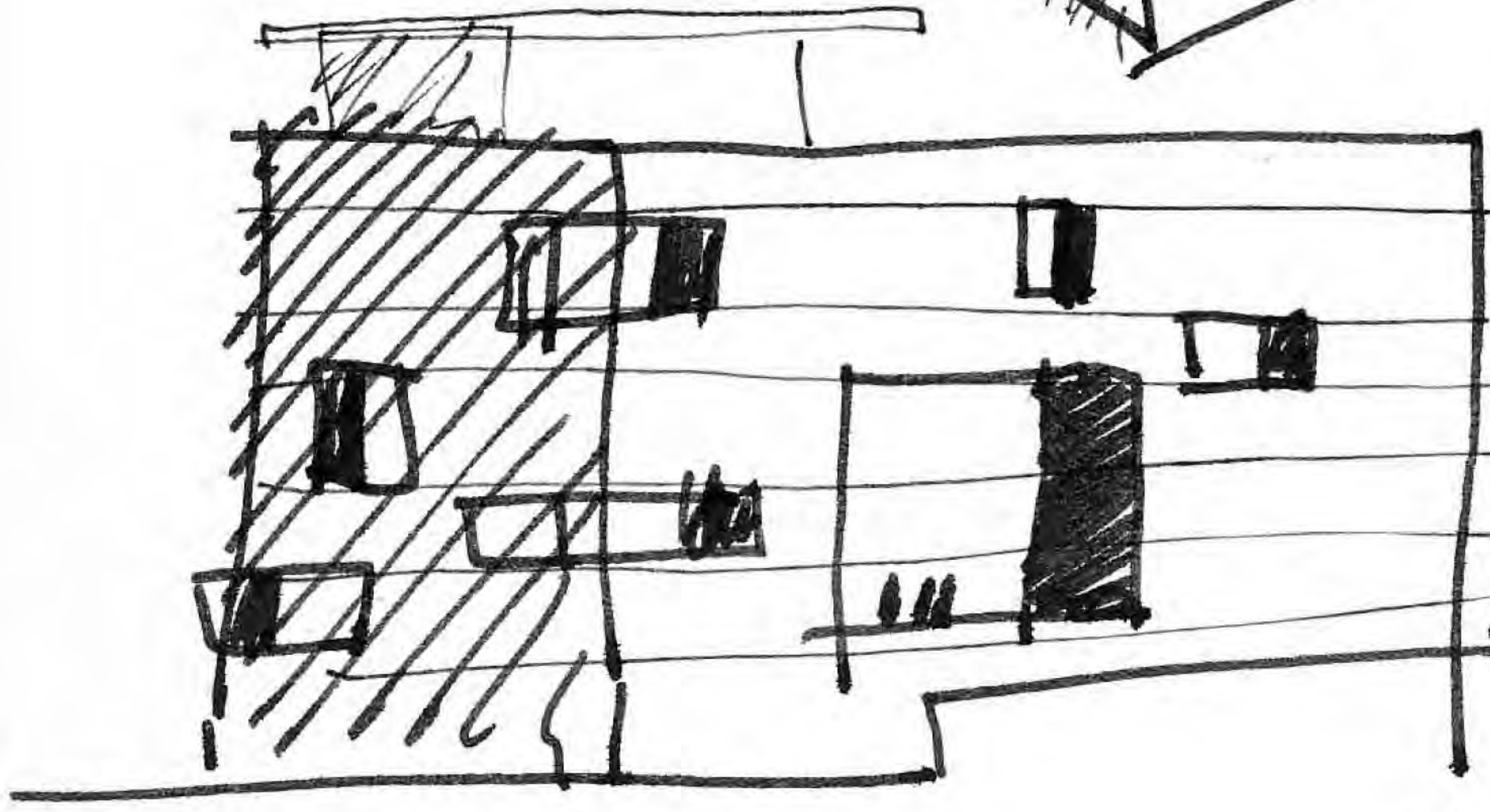
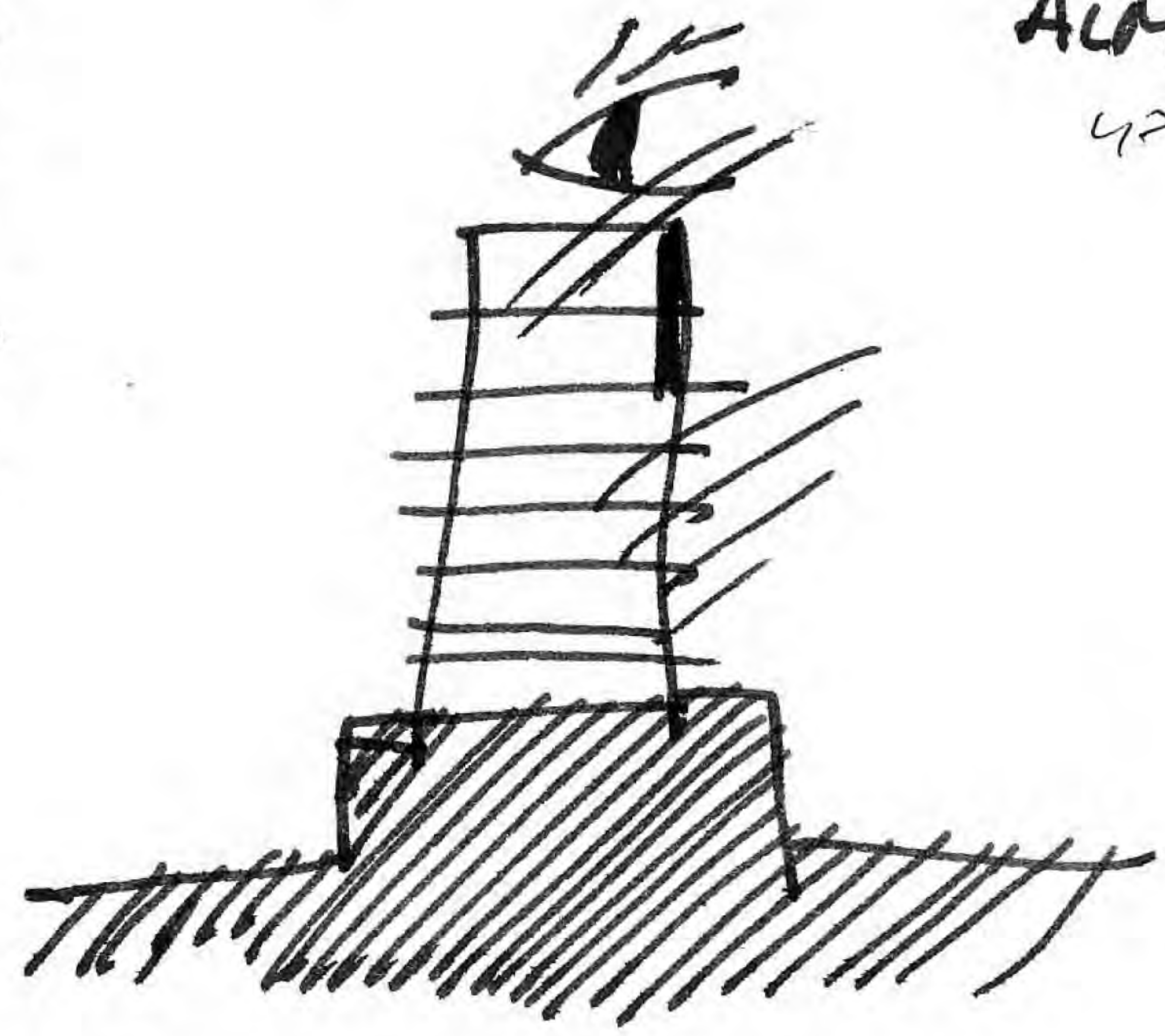
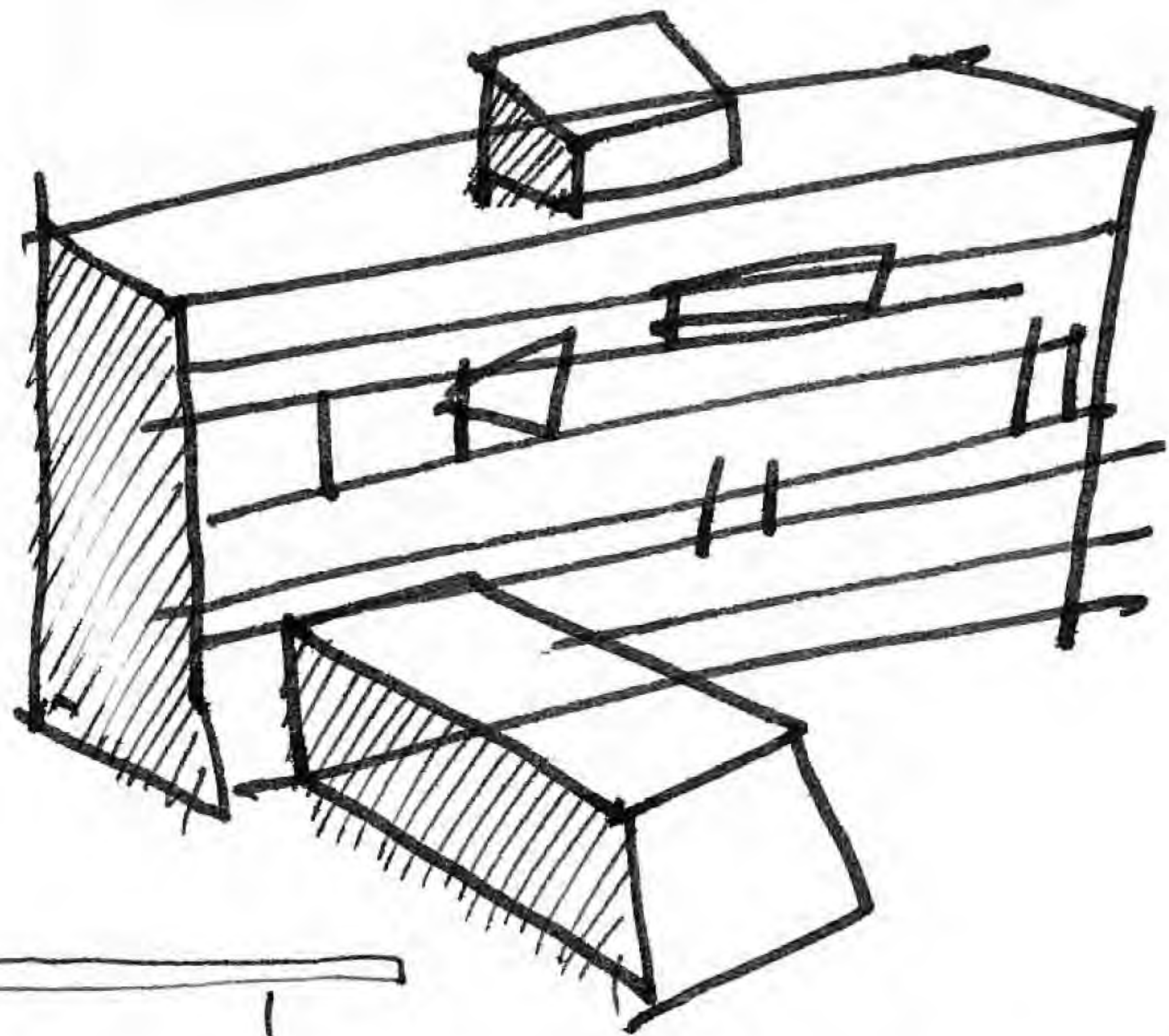

october 6 1997

en Cádiz

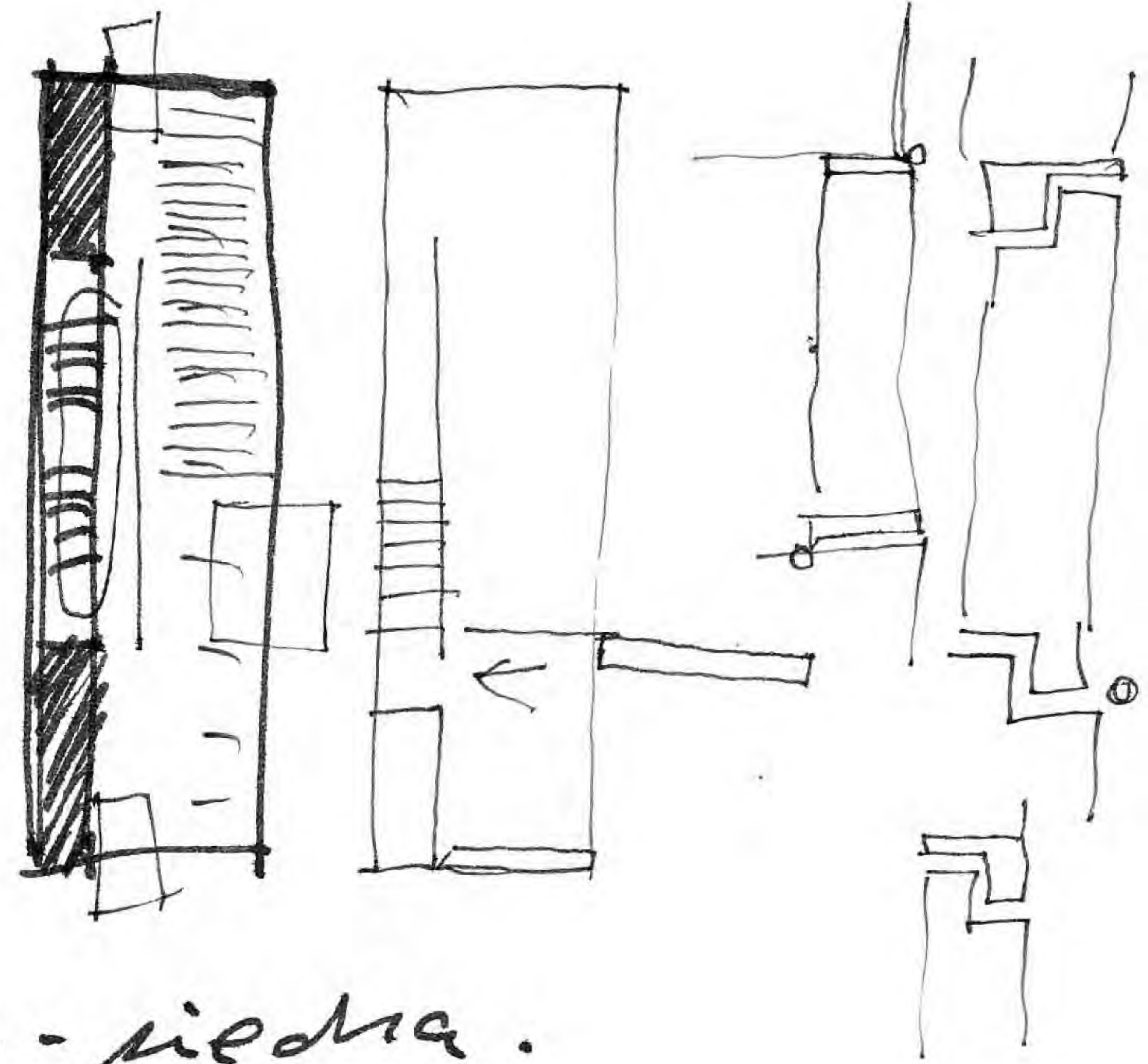
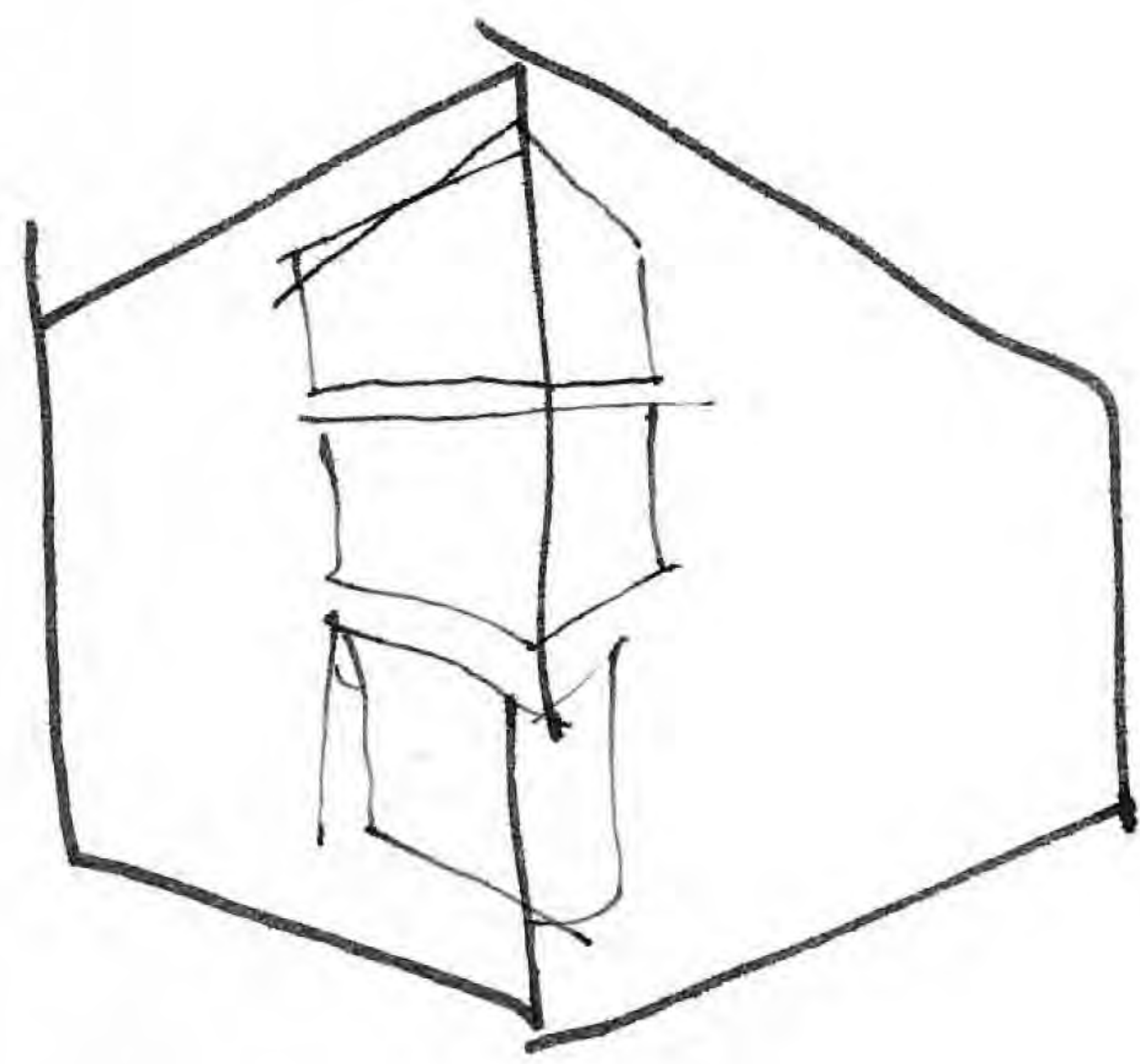

ALM

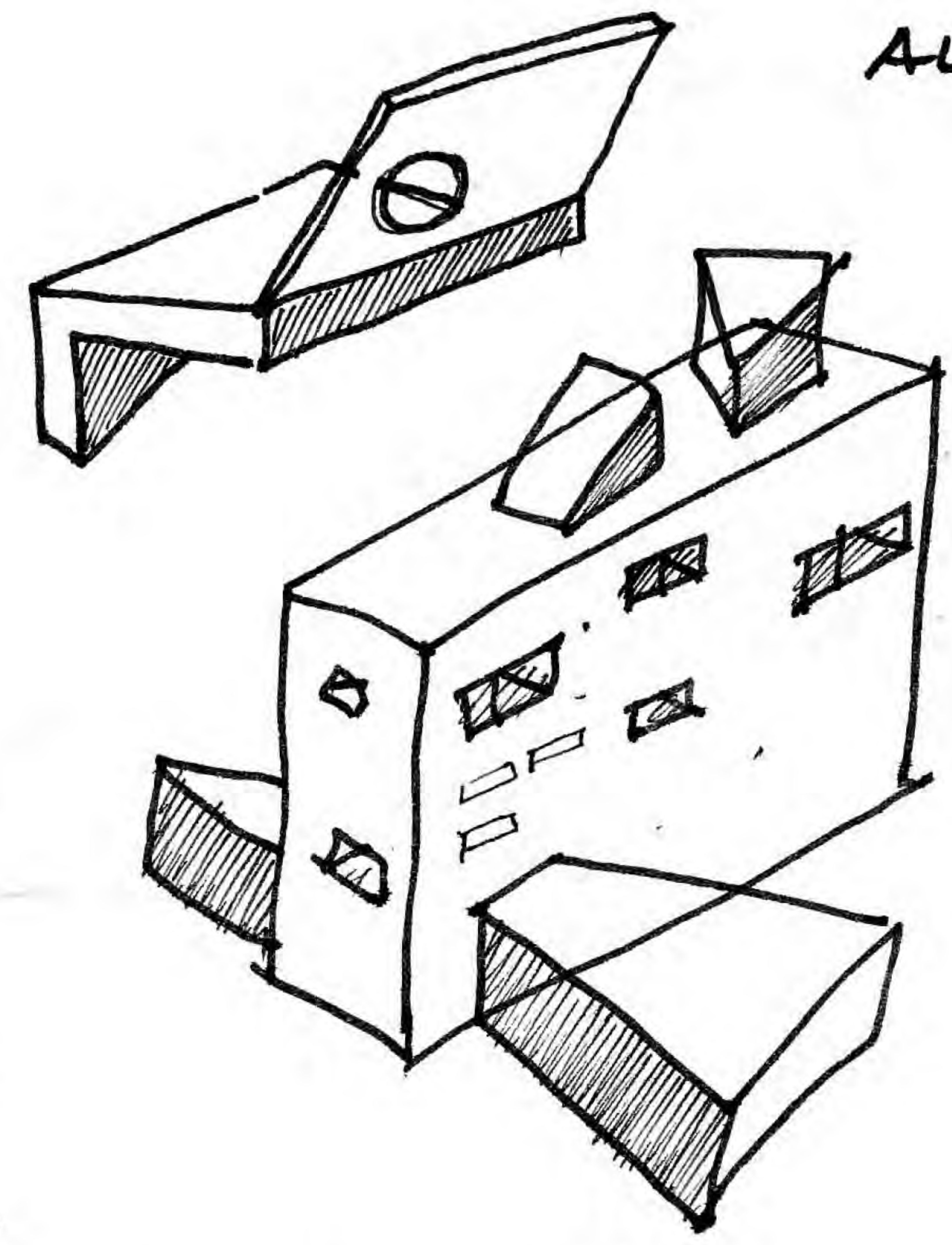
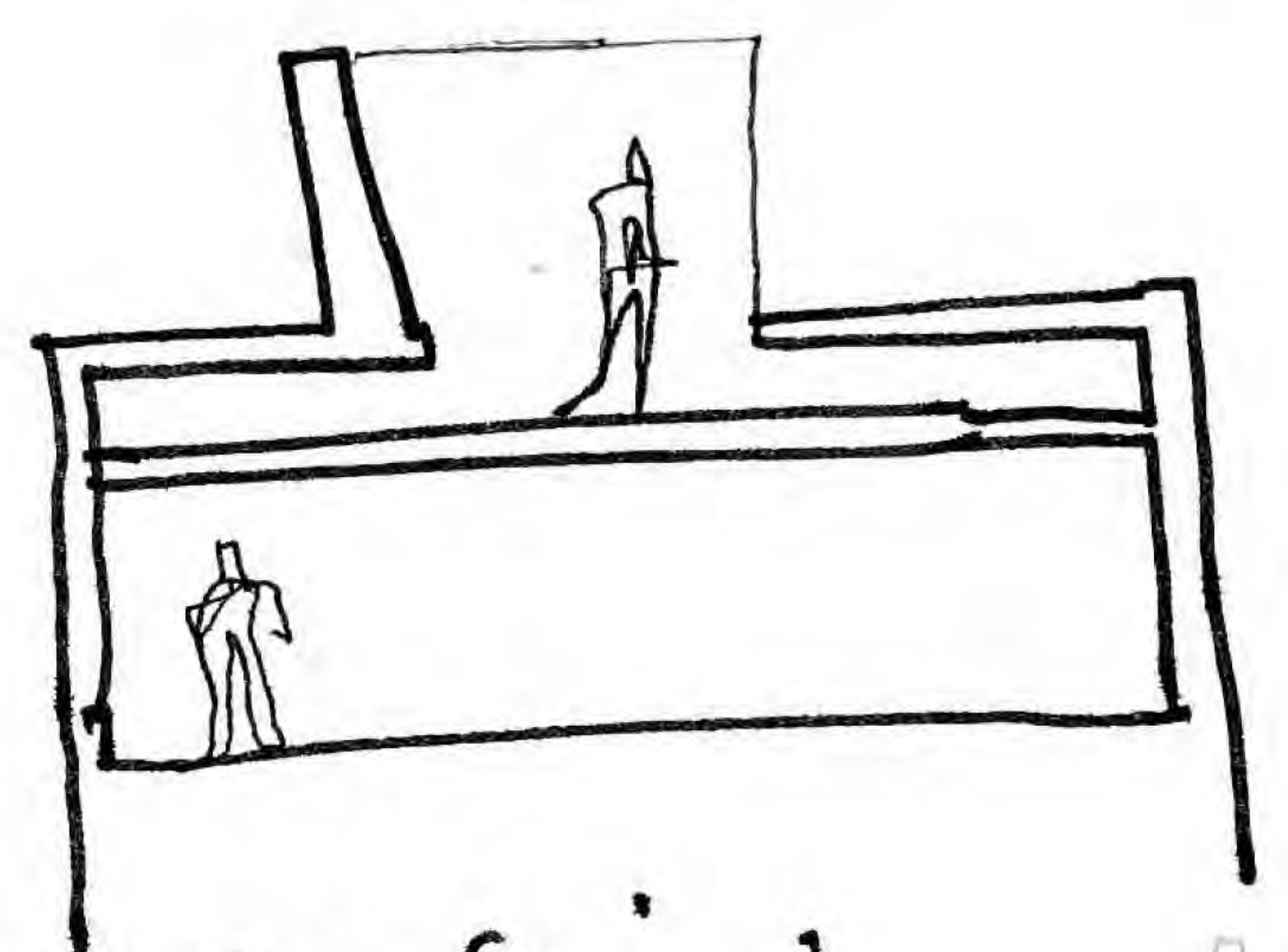

> hacer maqueta
1/1 de un hueco - piedra.
(con c. pluma)



Análisis
edificio
Almería.

- 7 forma - alargada
- 7 orientación norte.
- 7 circulación: centro de gravedad, núcleo de circulación 
- 7 estructura - sencilla clara unitaria 
- 7 piel - piedra - removible - ferrea CAJA
- 7 acentos (entrada - suelo - pies. azotea - cielo (ojo al mar, azotea - ojo 

7 Saber profrancia



- idea - clara
- espacio - acentos
- contr. - la carpintería con la piedra

7 fachada con armarios (sola) - competitio. - huecos

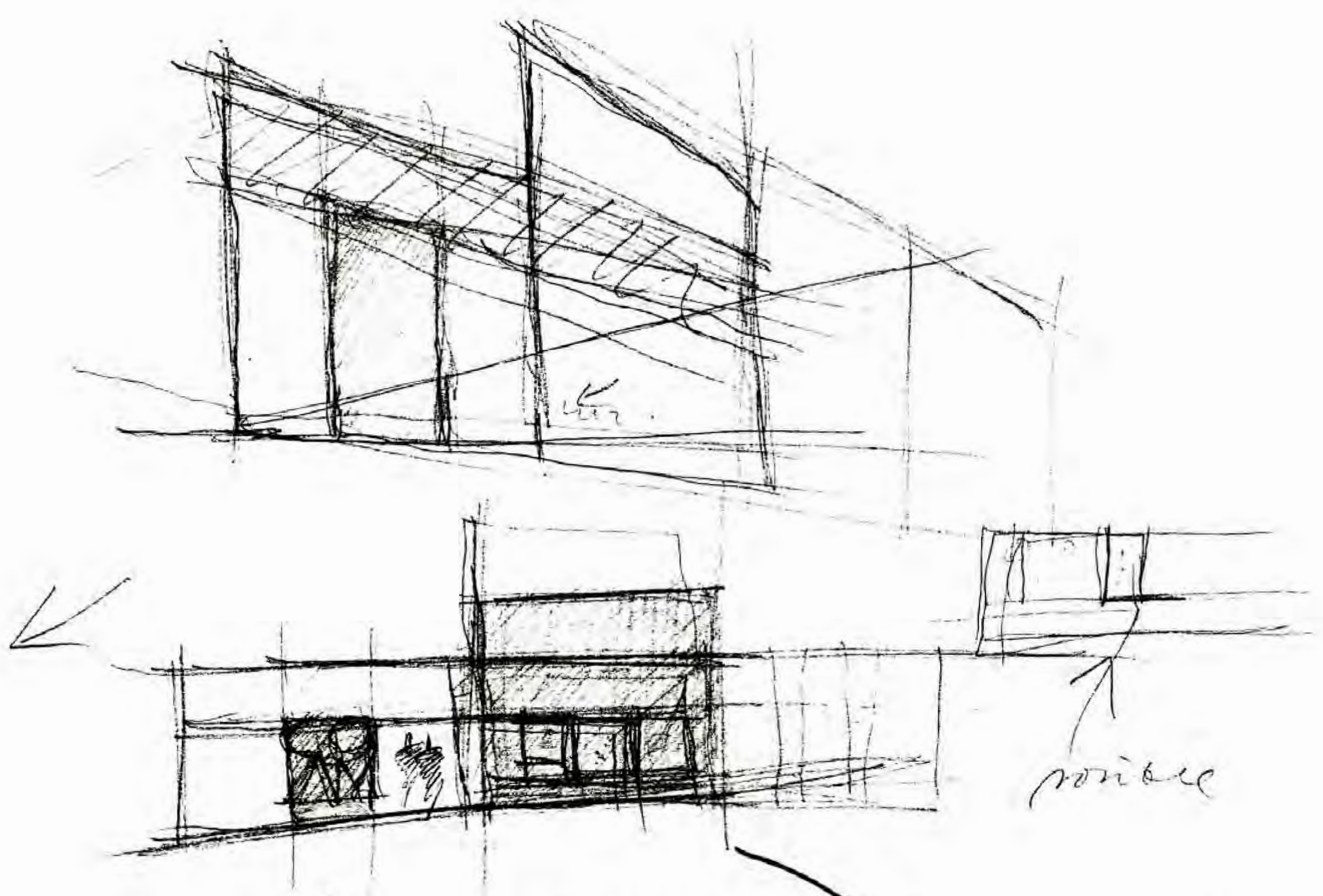

opaco? (piedra)
 transparente (vidrio)
 (fibra vidrio) (termovent).

luz al fondo
 CARTELERIA
 (anuncios con luz)

día > Absorbe la luz
 noche? emite la luz.

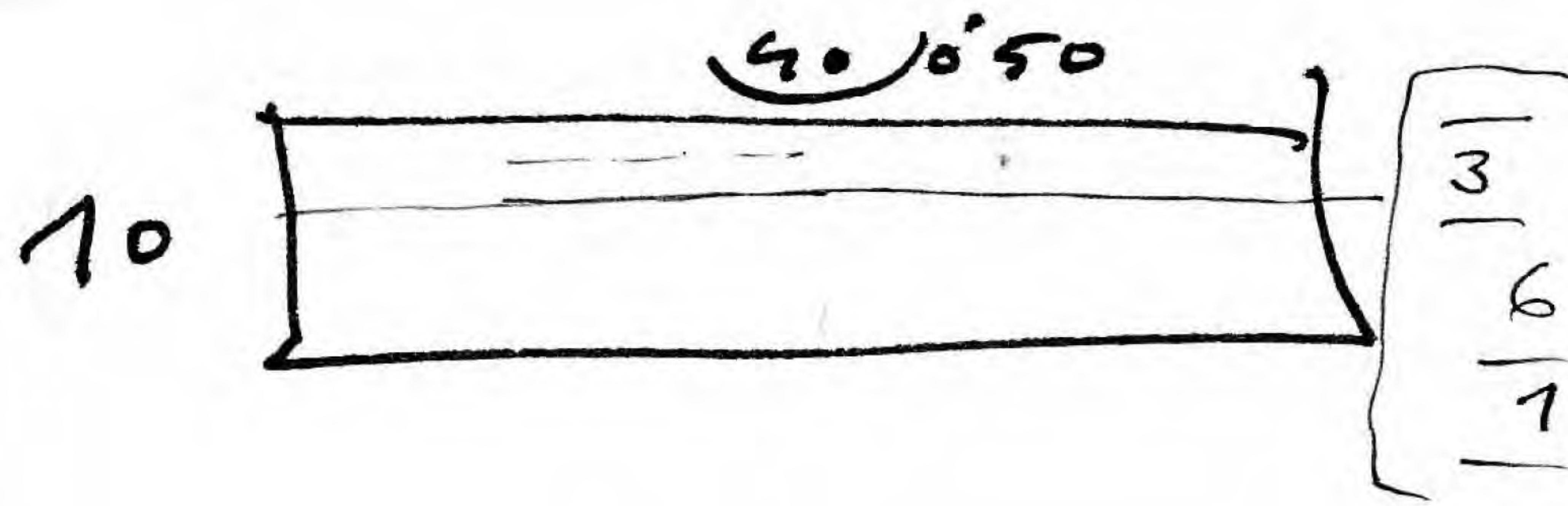

$(-1'5 + 1'5) + \dots$

ALM.^o
13. oct 97.
93

I II

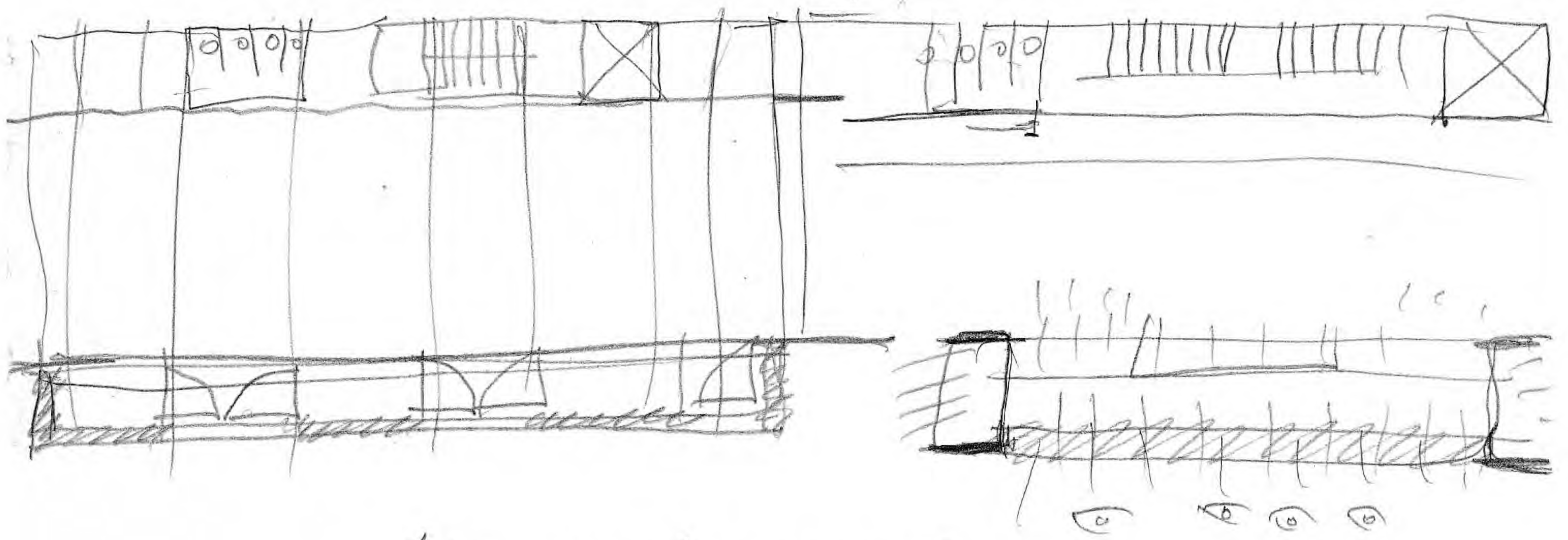

las cuatro esquinas
de piedra cenada.

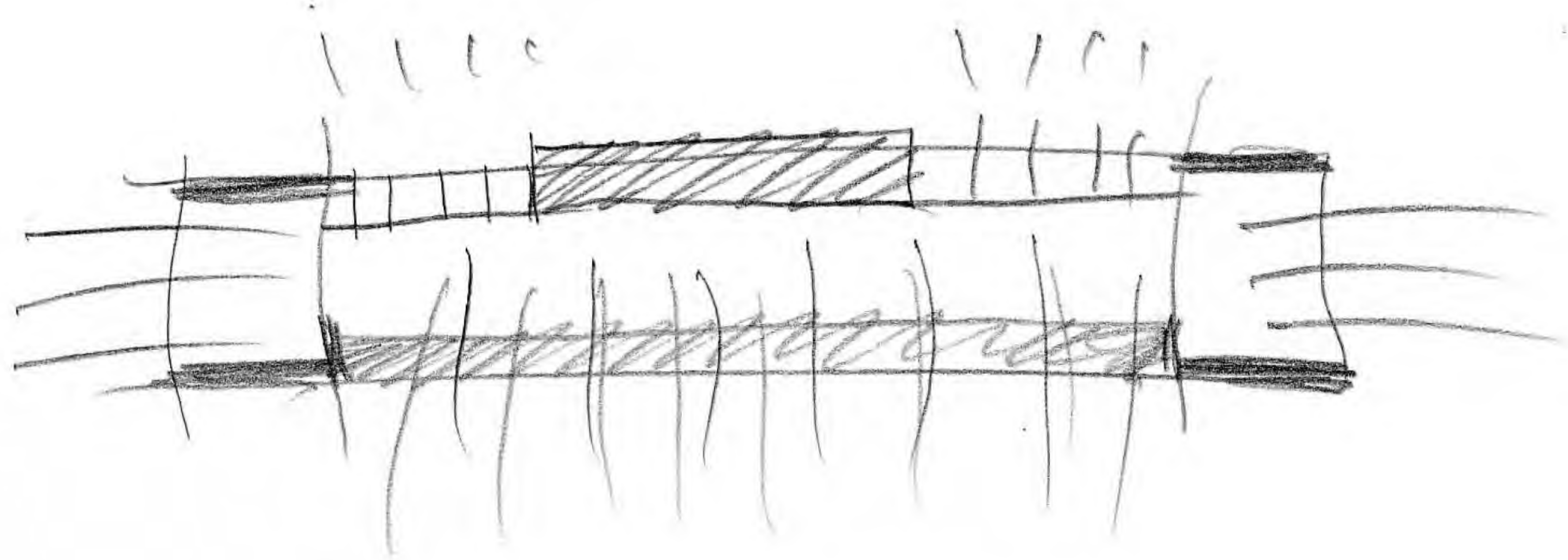

COAM

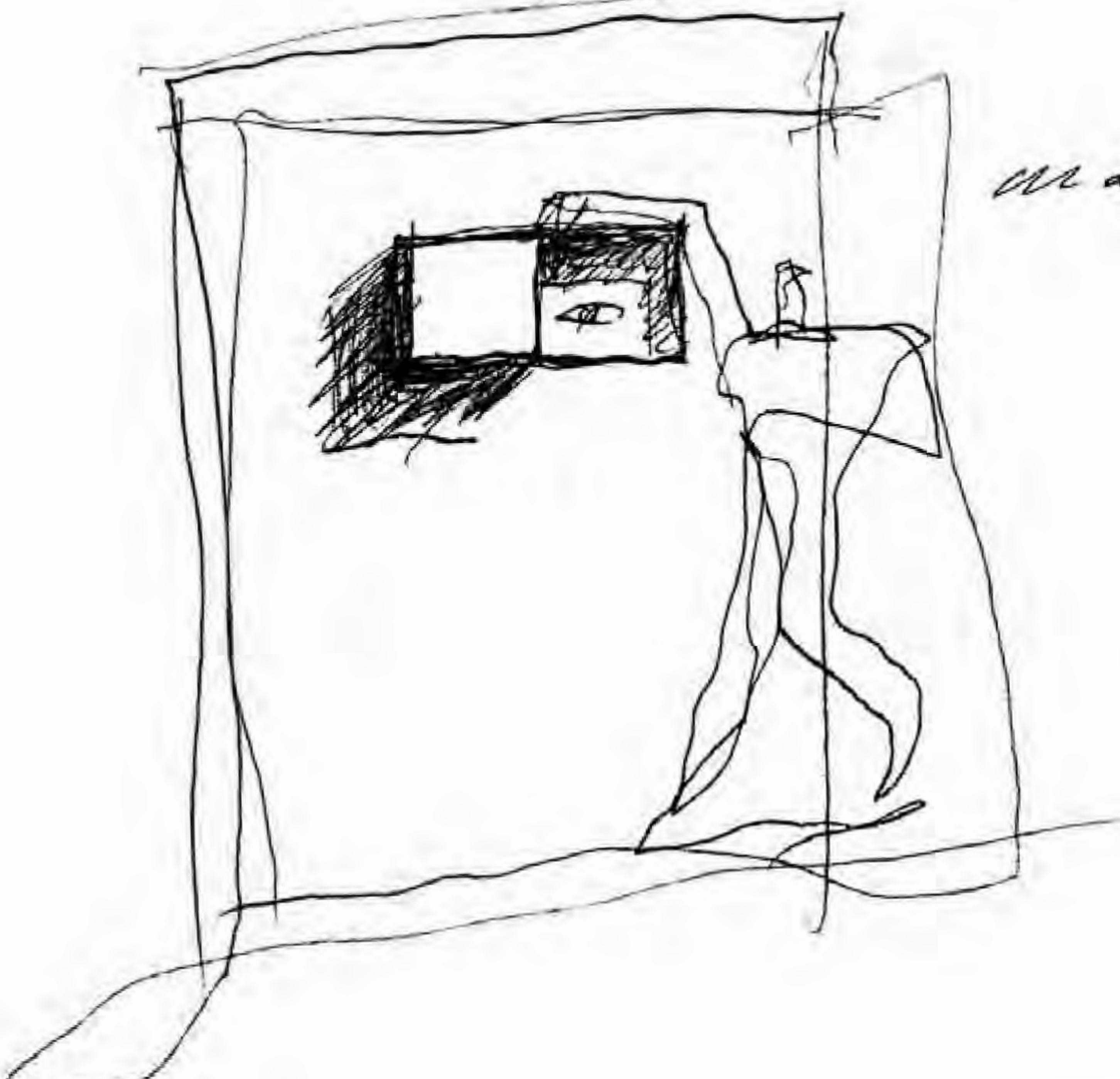
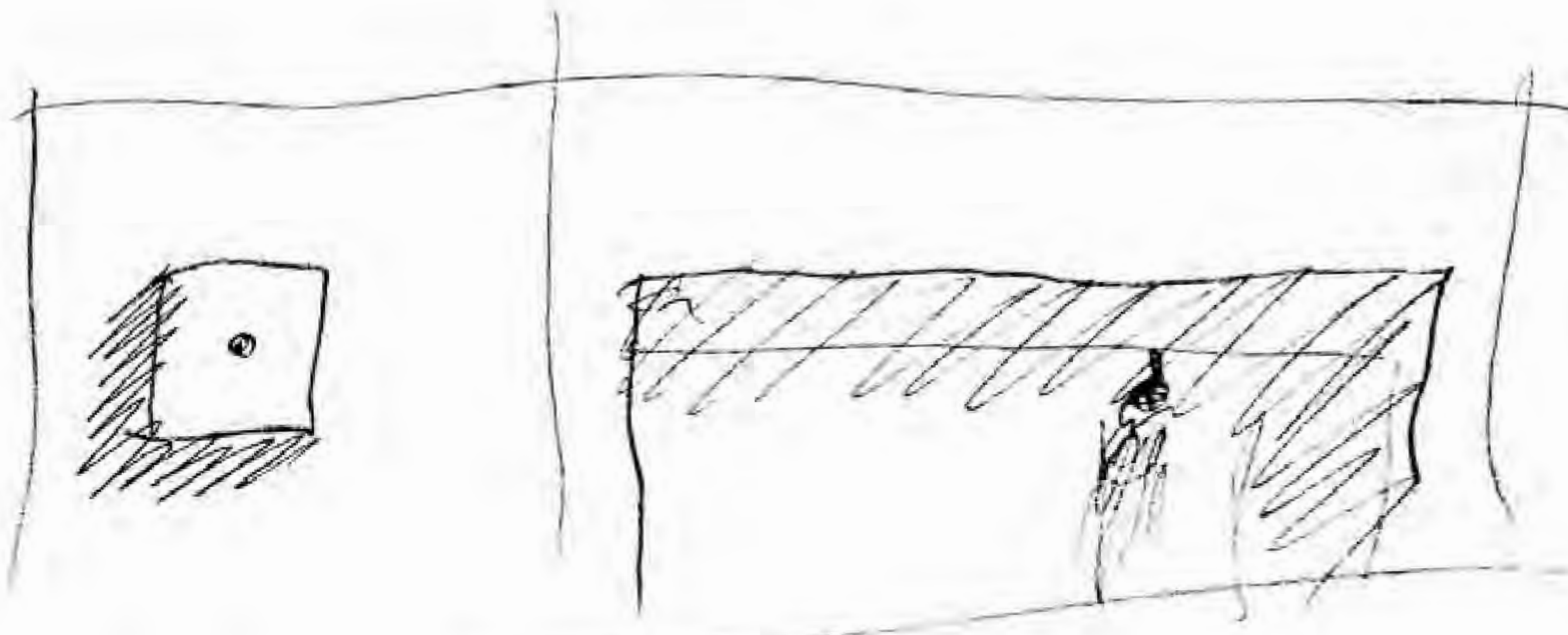
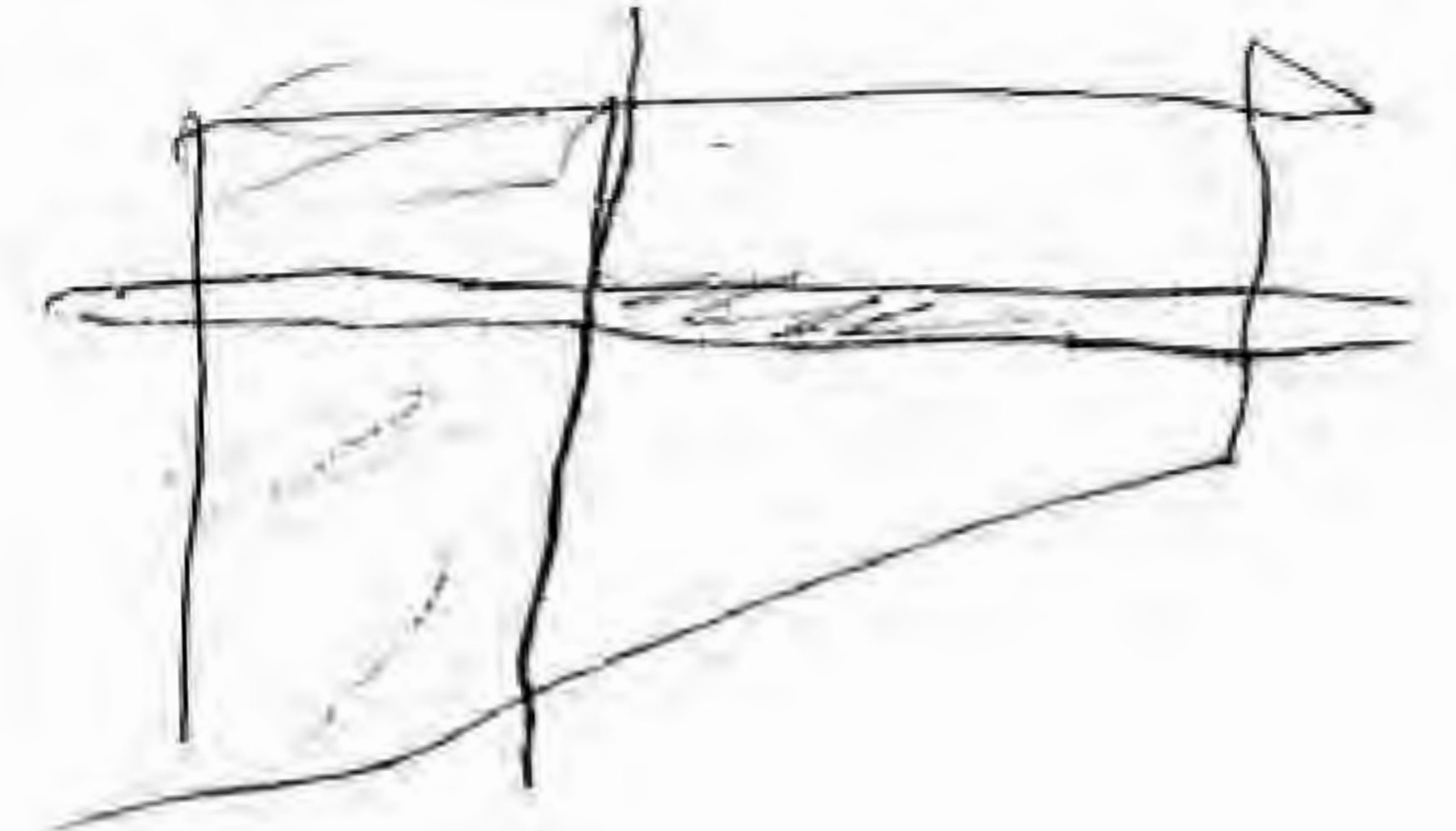
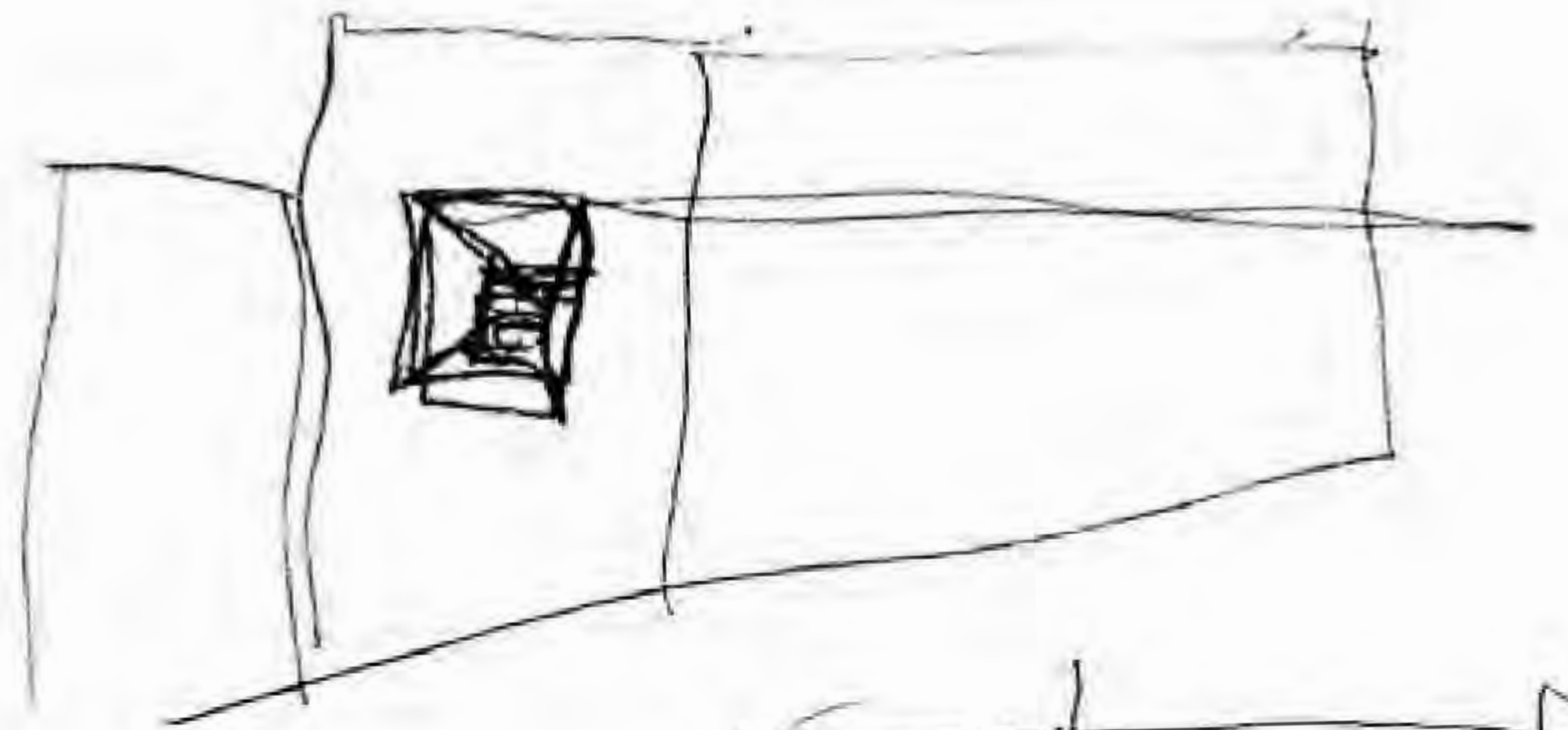
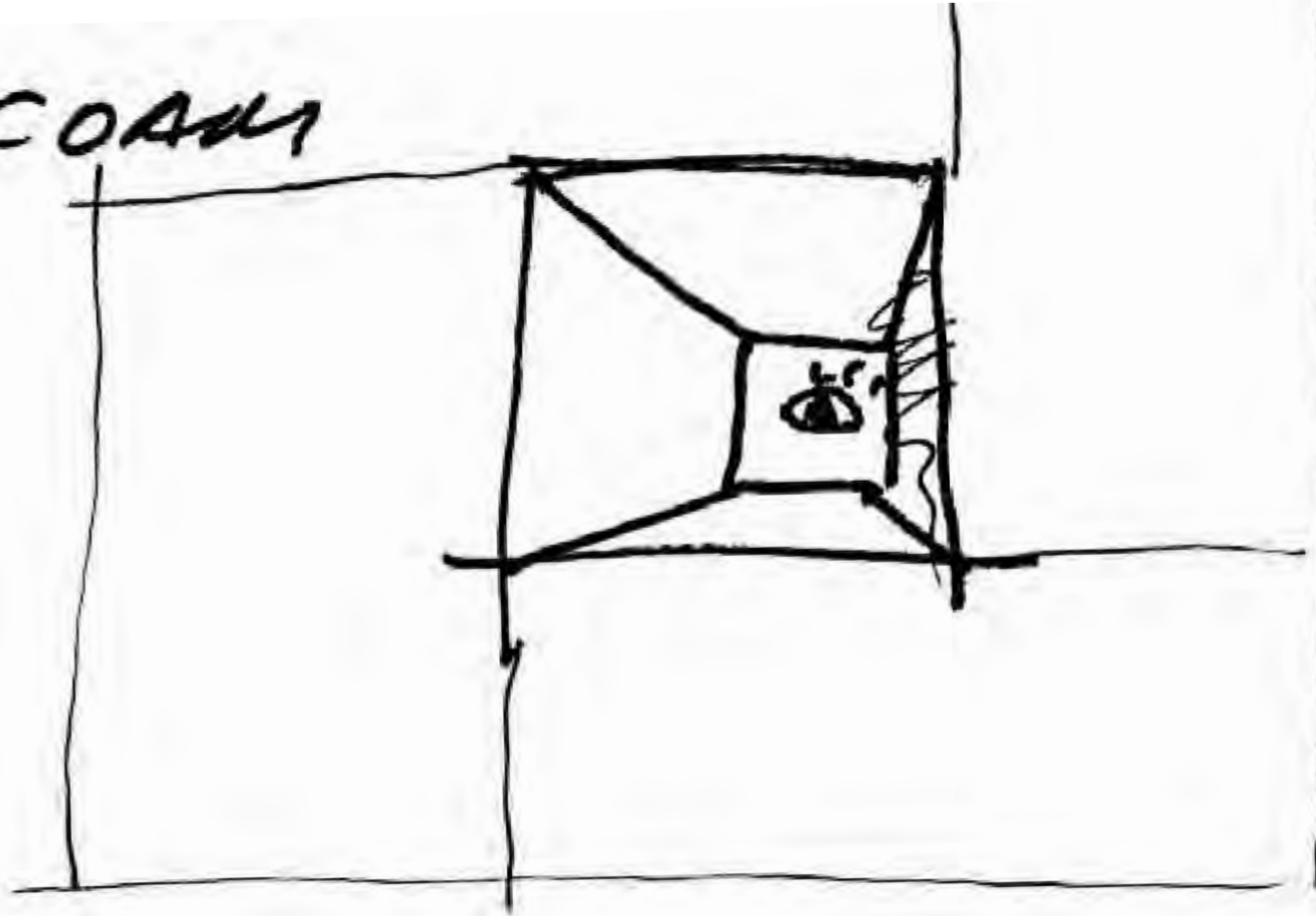

marky 21 octubre 1997

ALMERIA.
(October 21. 1997).

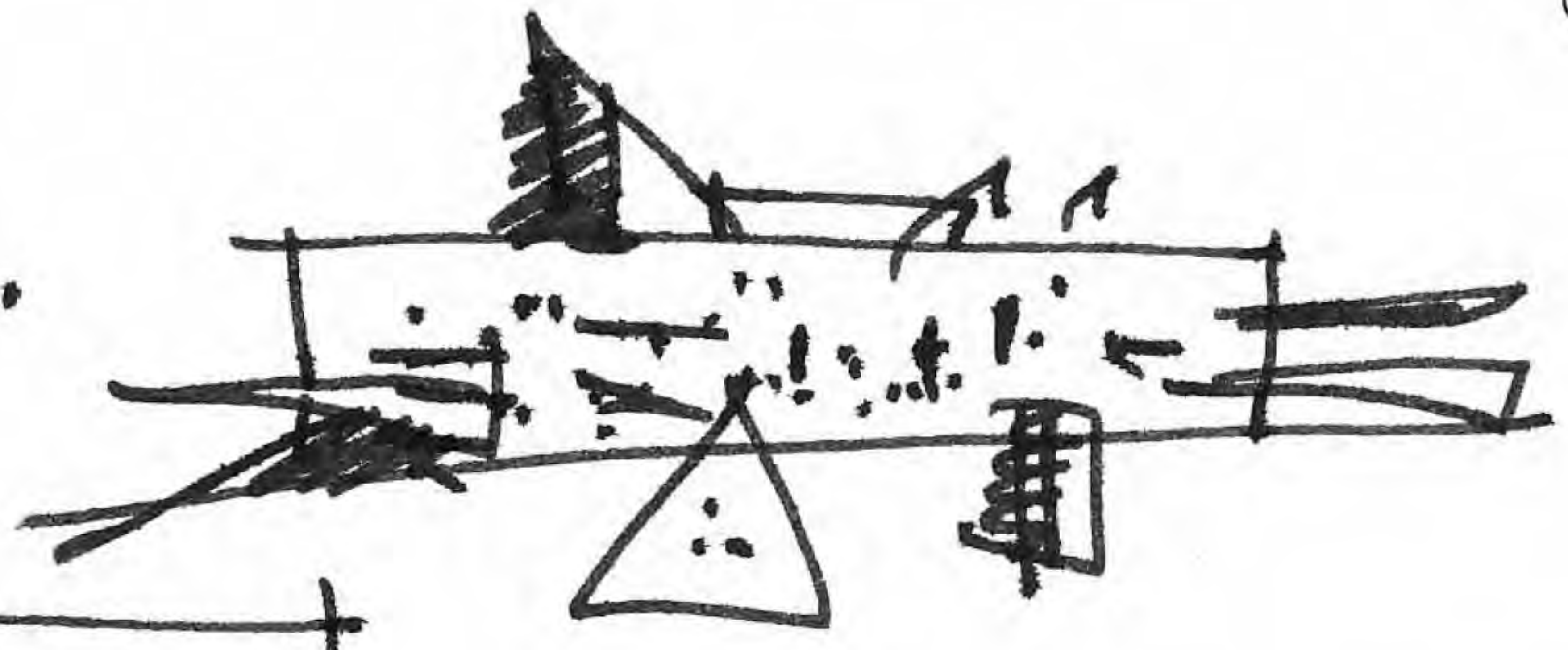
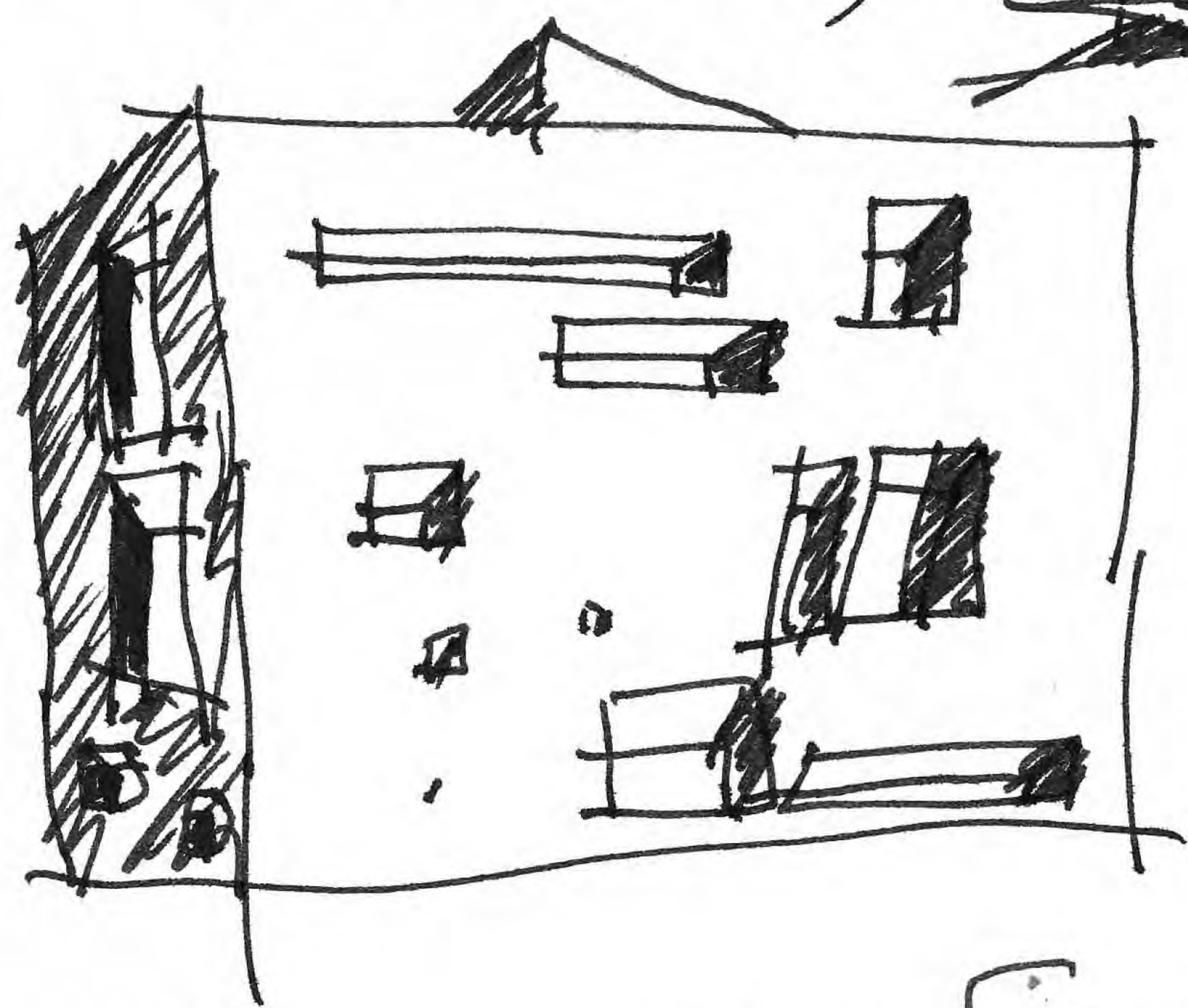

... alí de Madrid el 5 oct. (16 días)
voy 21 oct

→ en Cádiz

- plus volas et... ? Espinas
 - tapias. Clucana.
 cocina casa

→ en Madrid

↑
↑

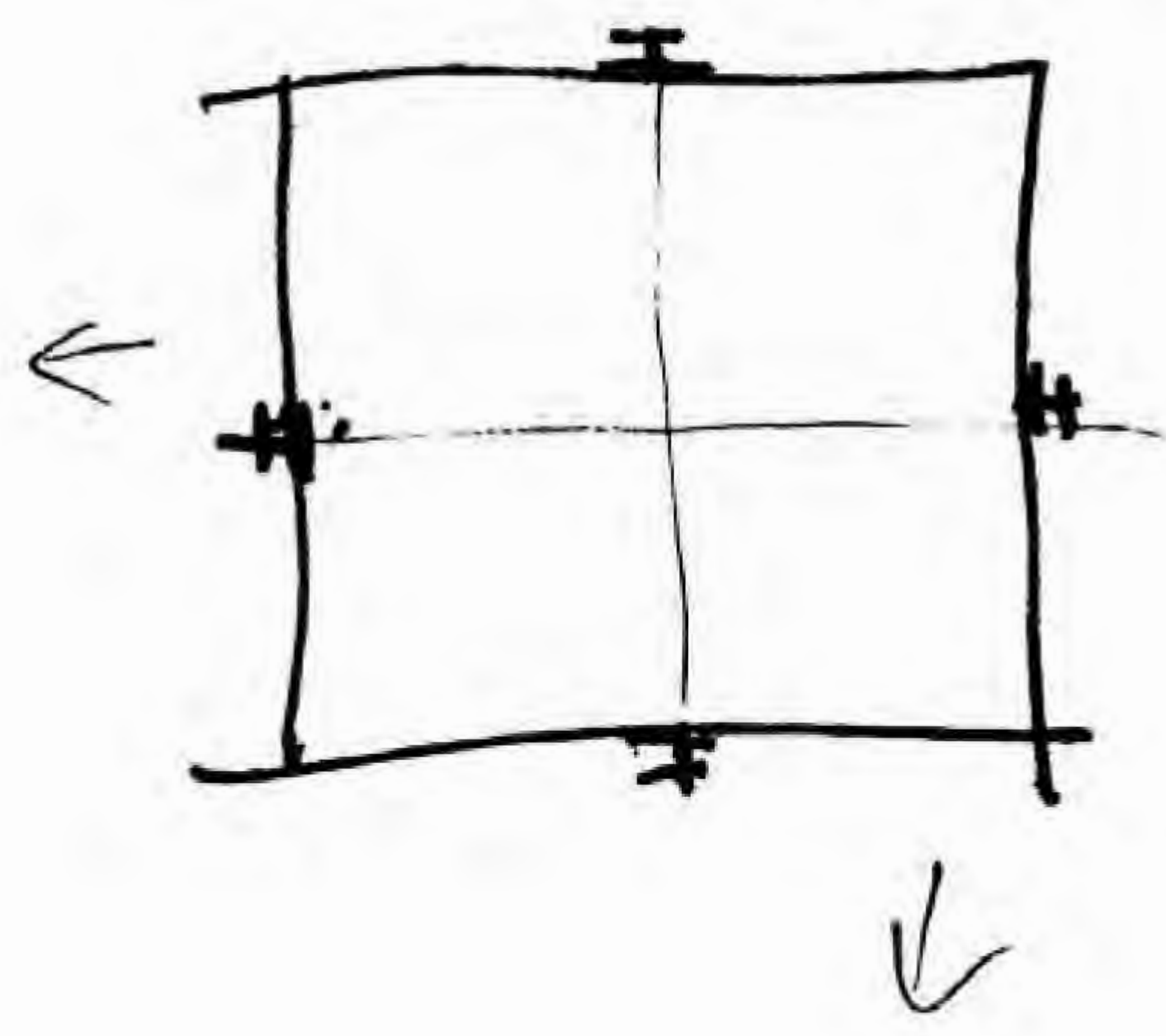

→

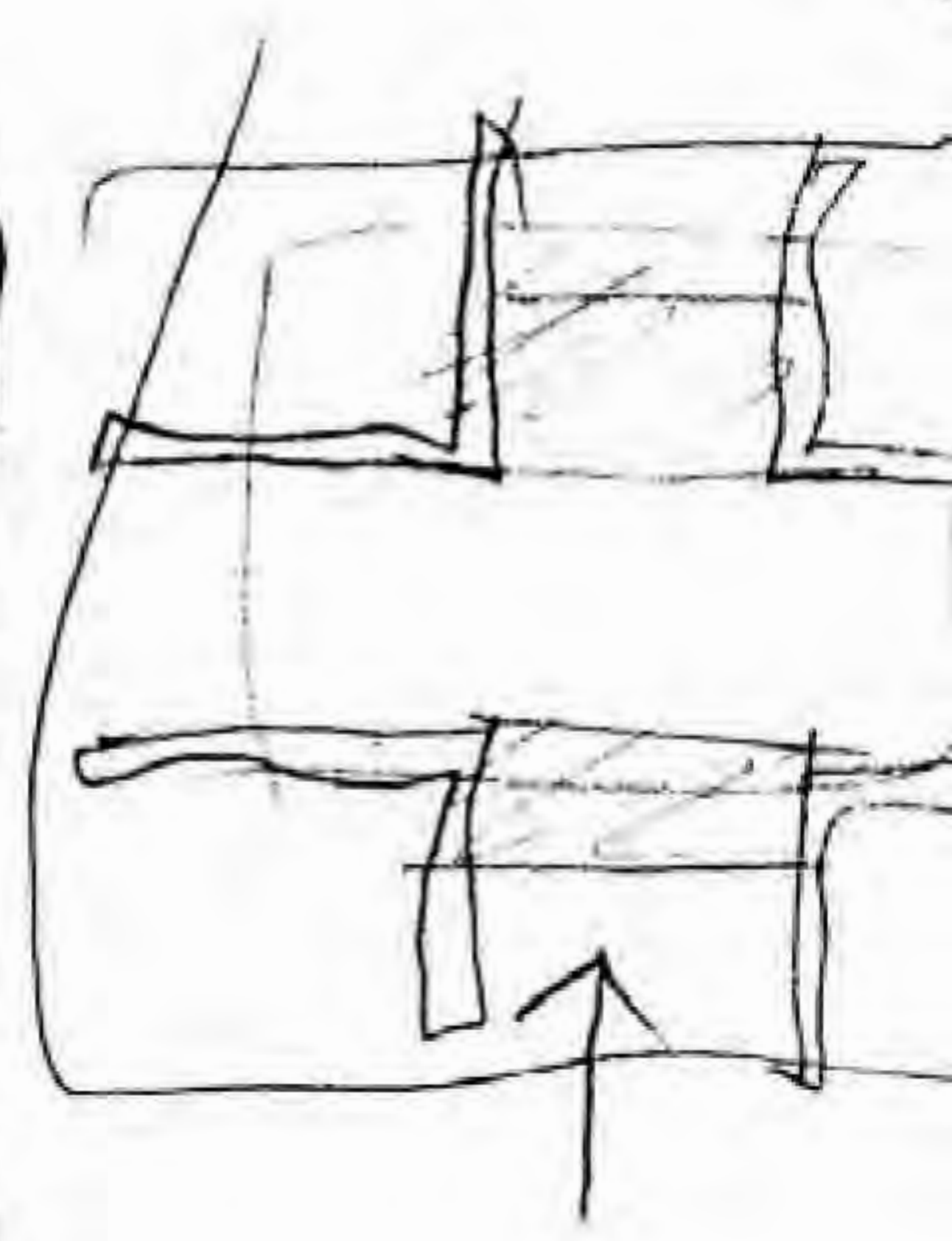
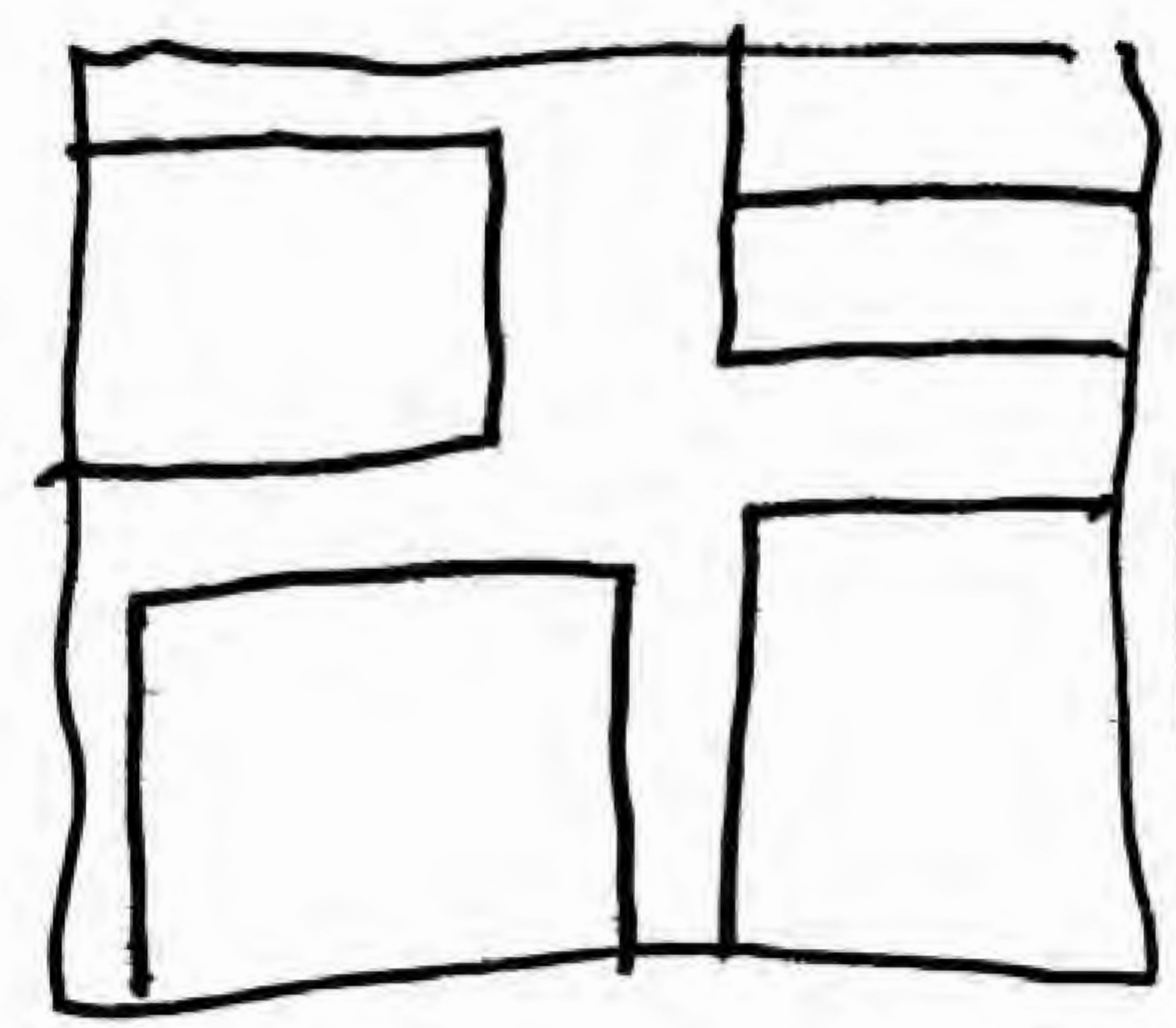

↘

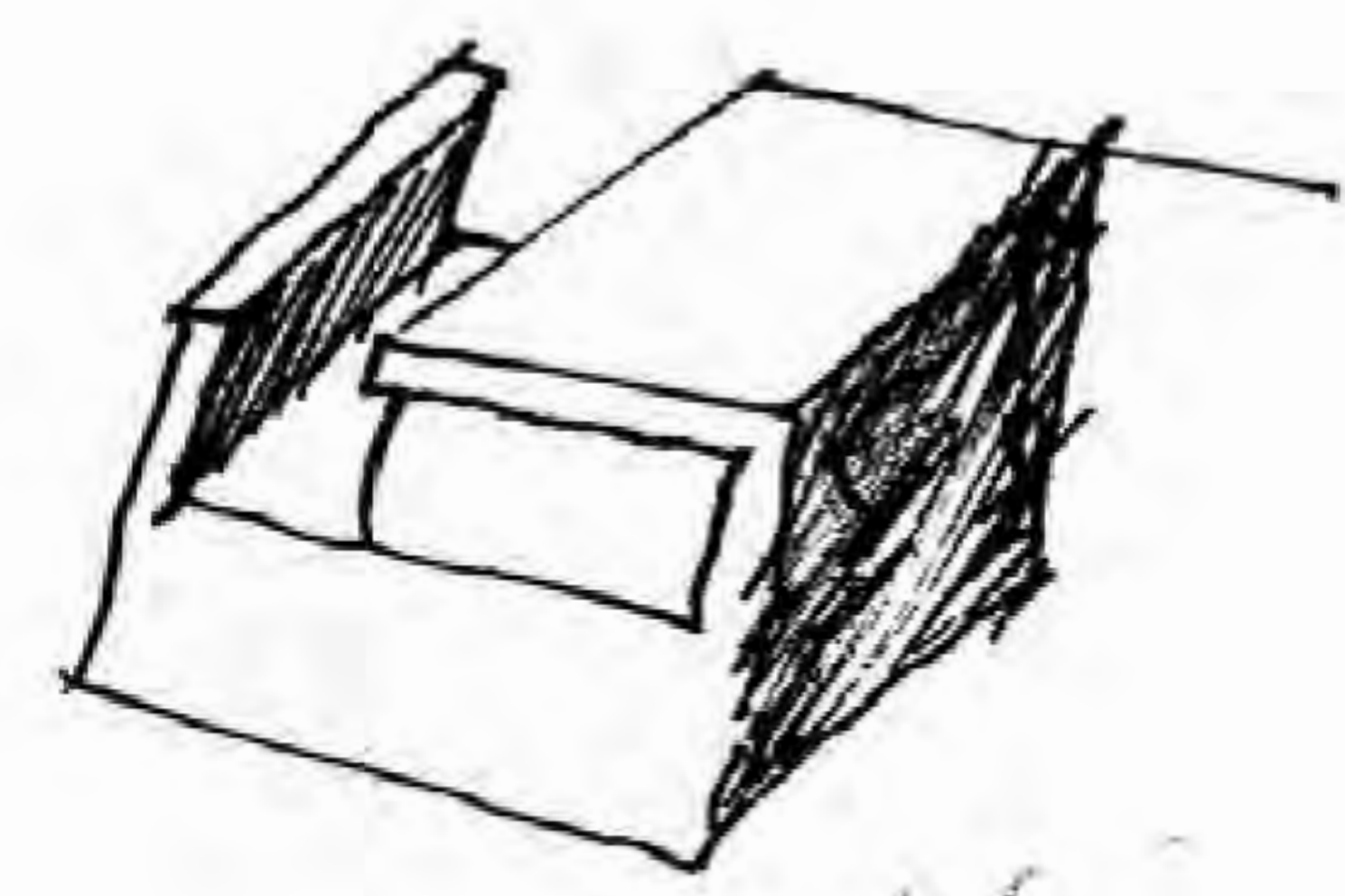
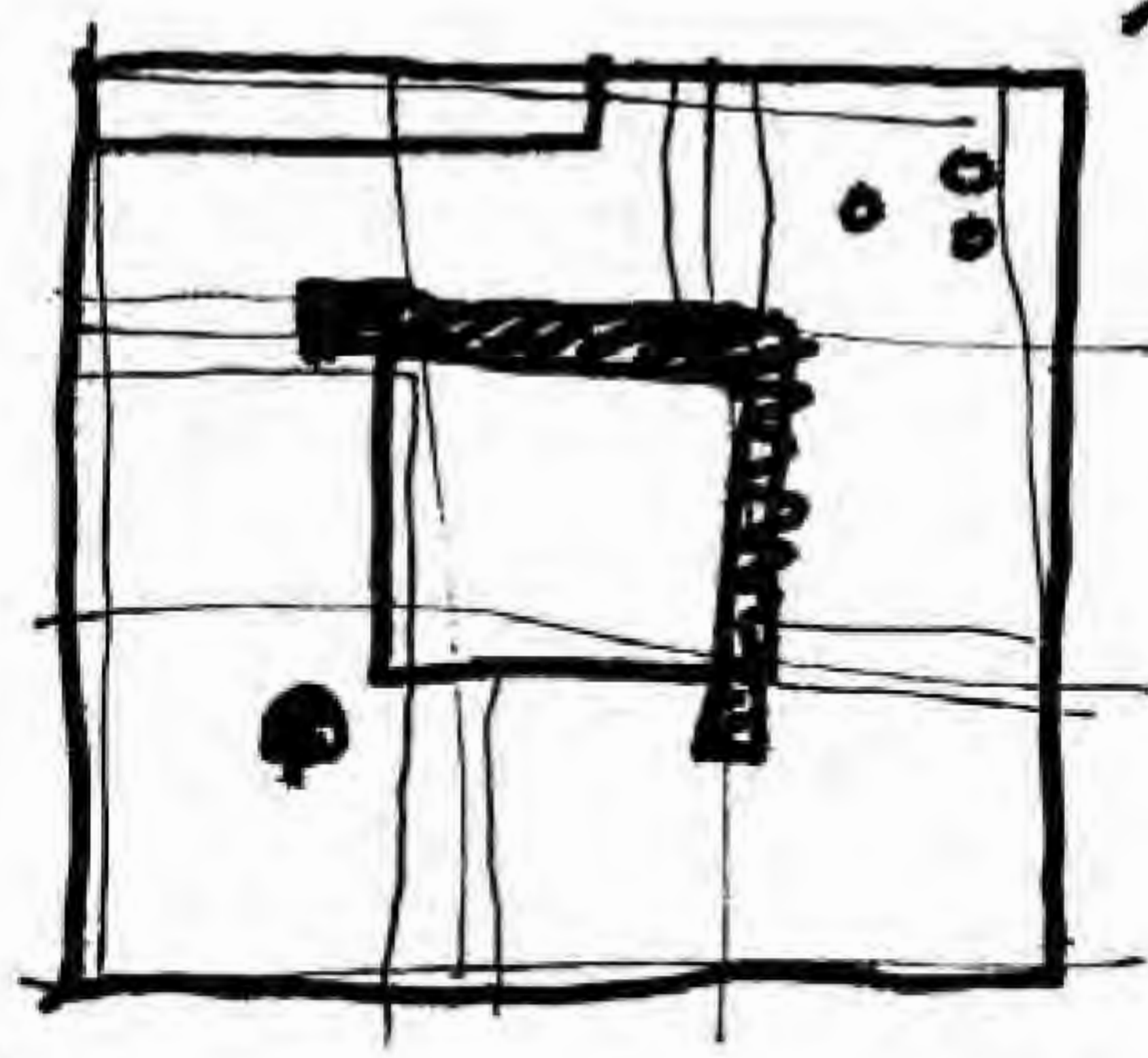
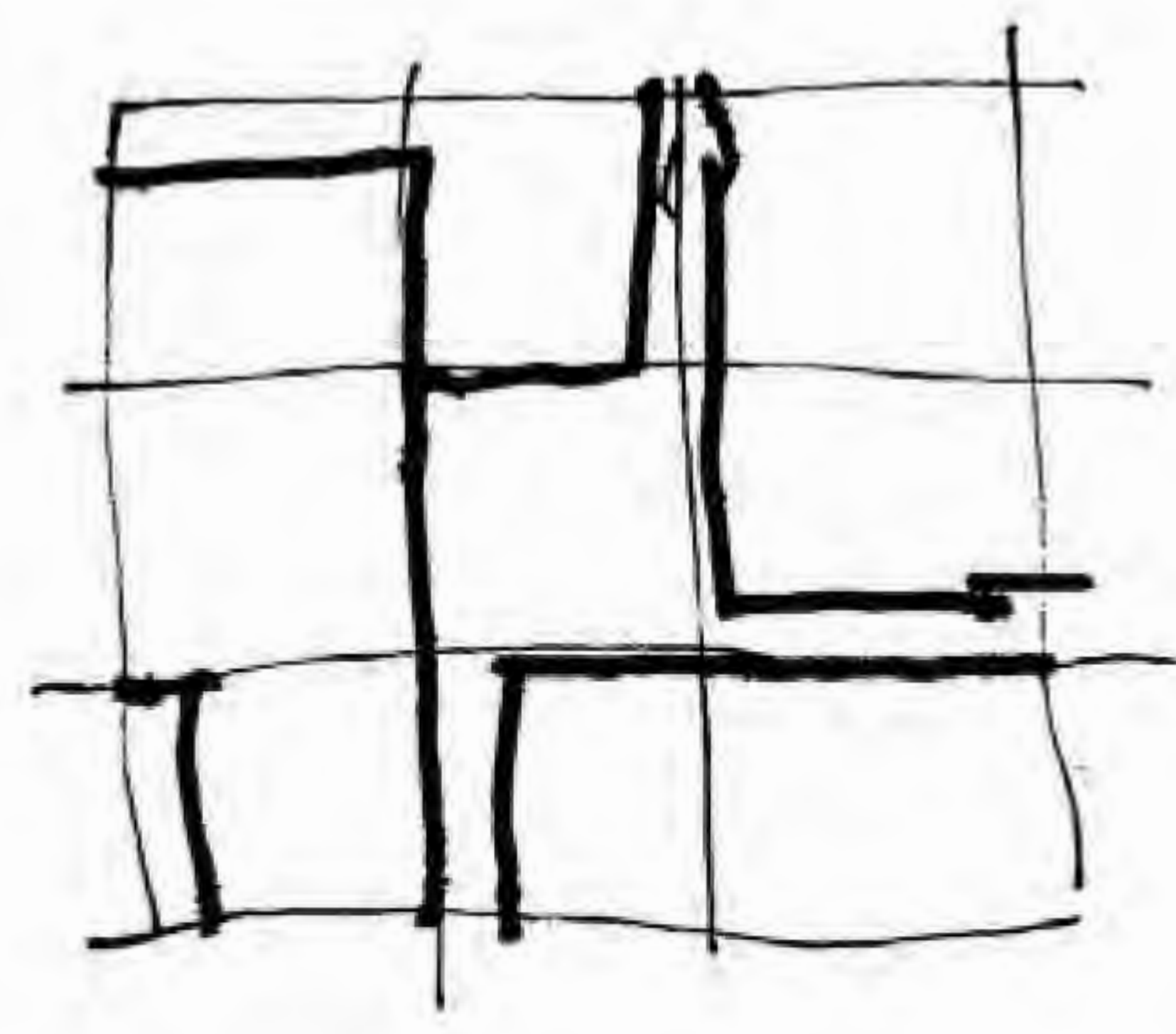

↘

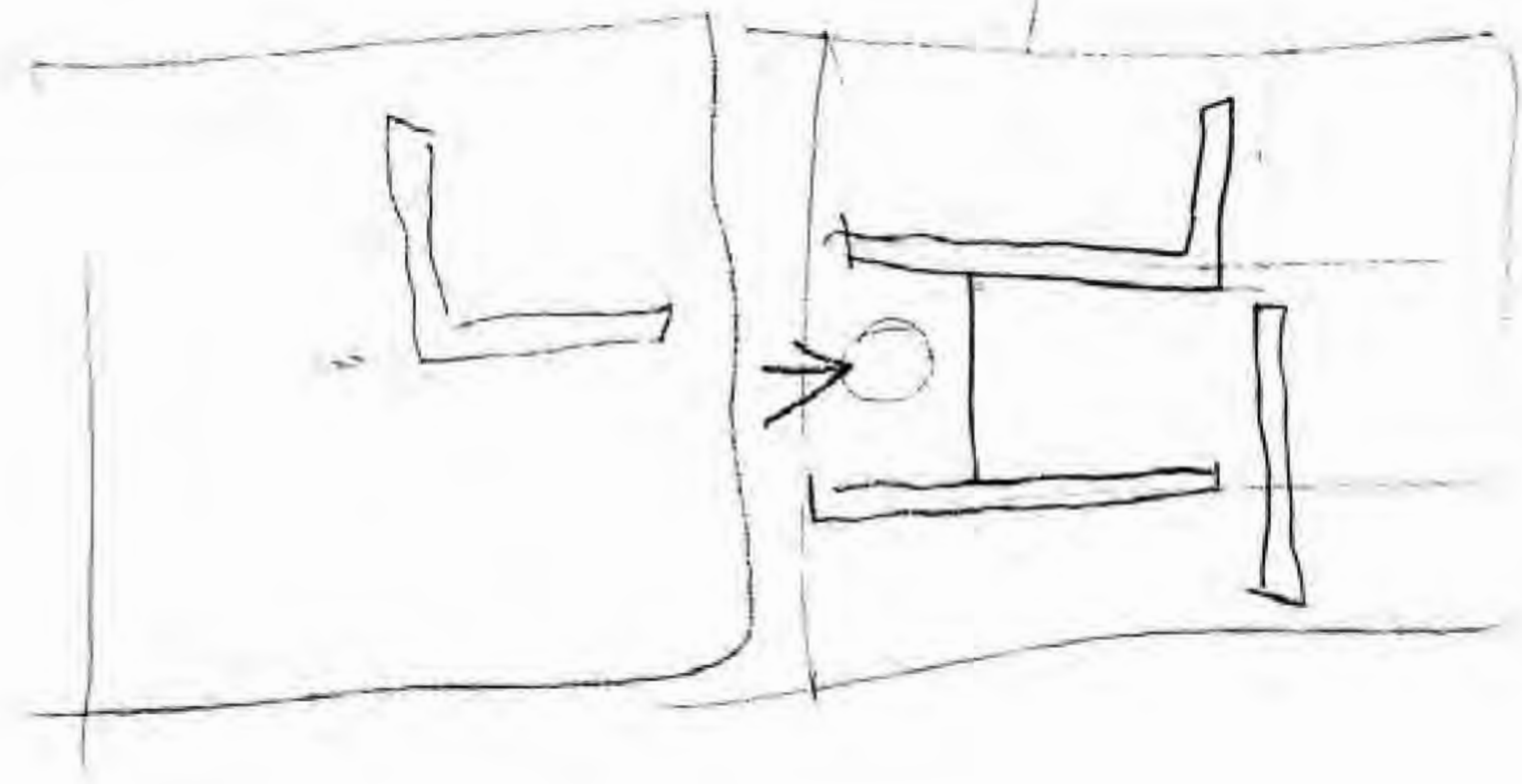
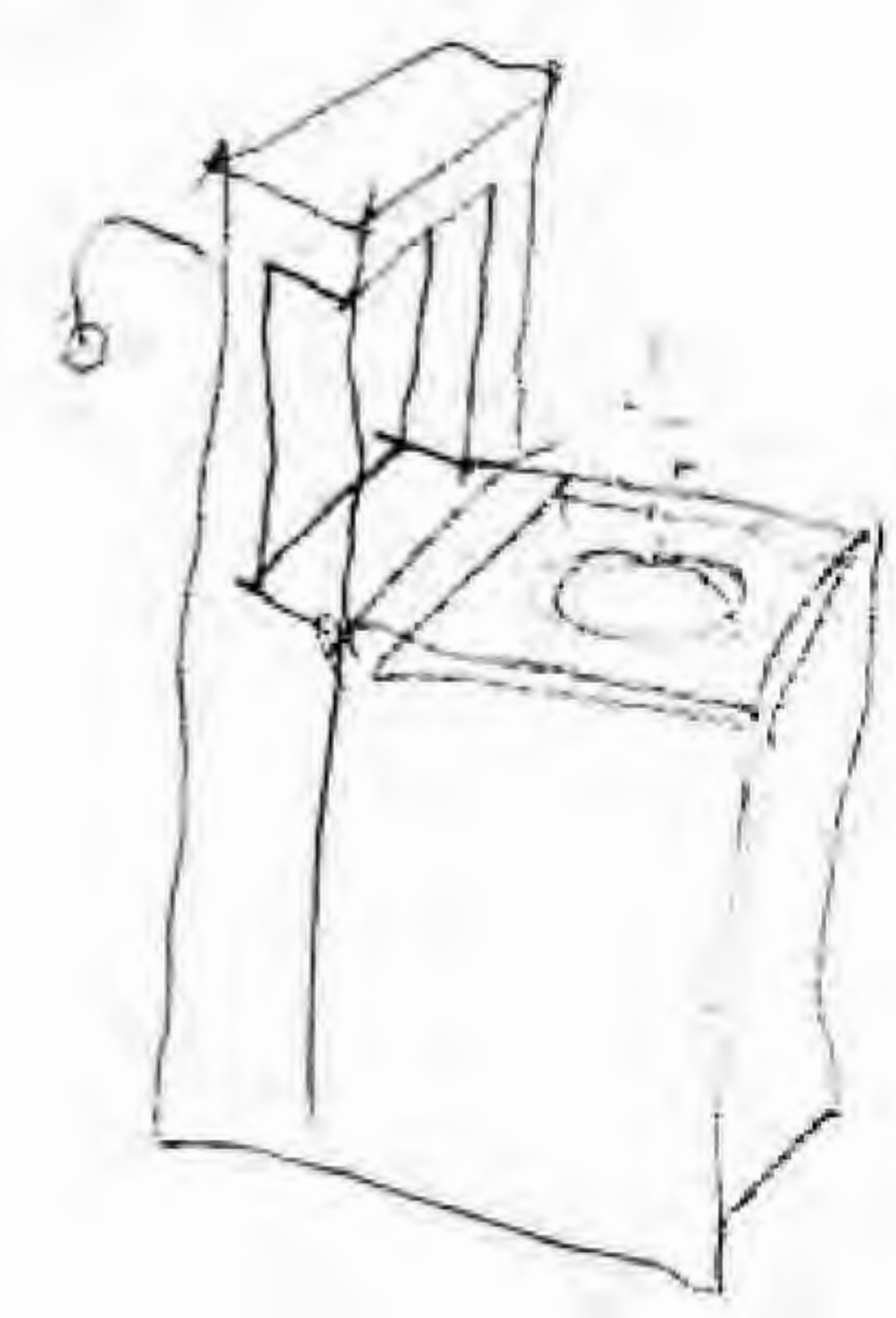

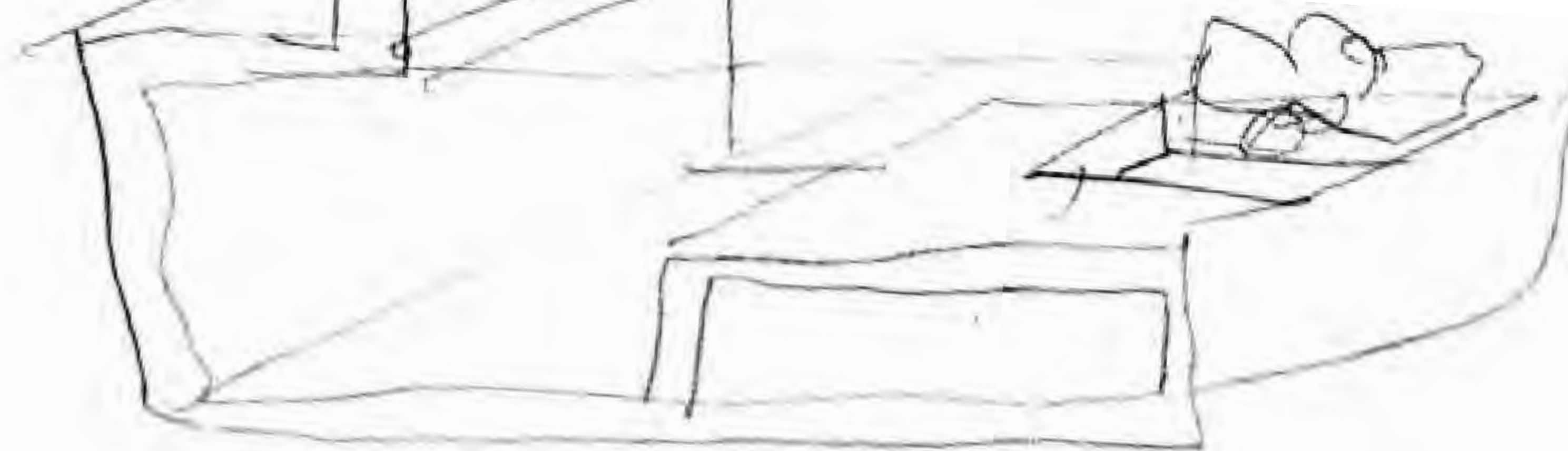

MESTRE

(piedroy al borche del
Canal de Venozza
de SCARPA

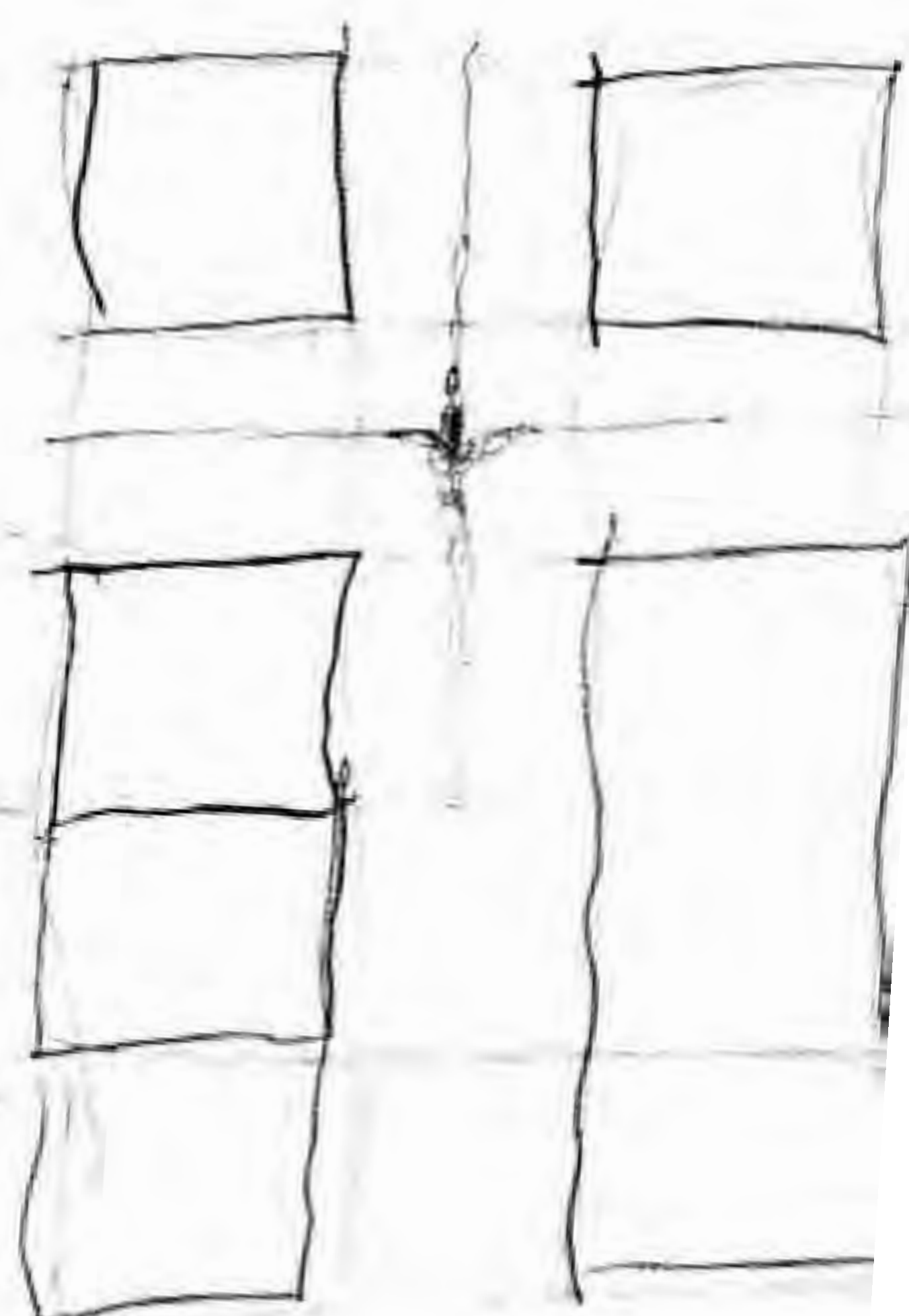
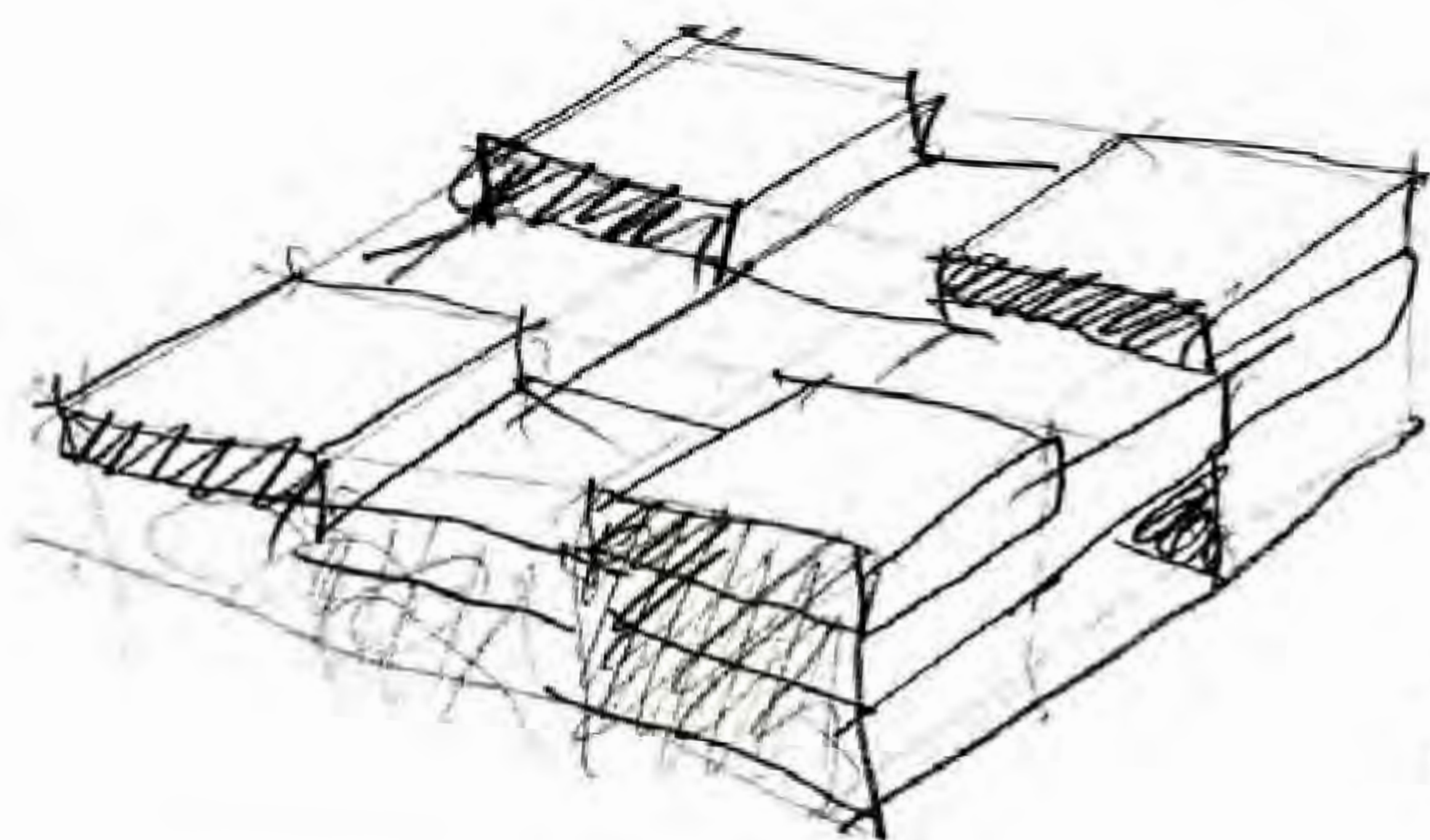

FIORI *fiore*

FIAMMI *fiamme*



	1	2
5	PA OLA	AD AL BE RTO
3		
4		

SEBASTIANO

*	*	x	*
x	+	x	x
Δ	0	0	0
∠	0	0	0
0	0	0	0
0	0	0	0

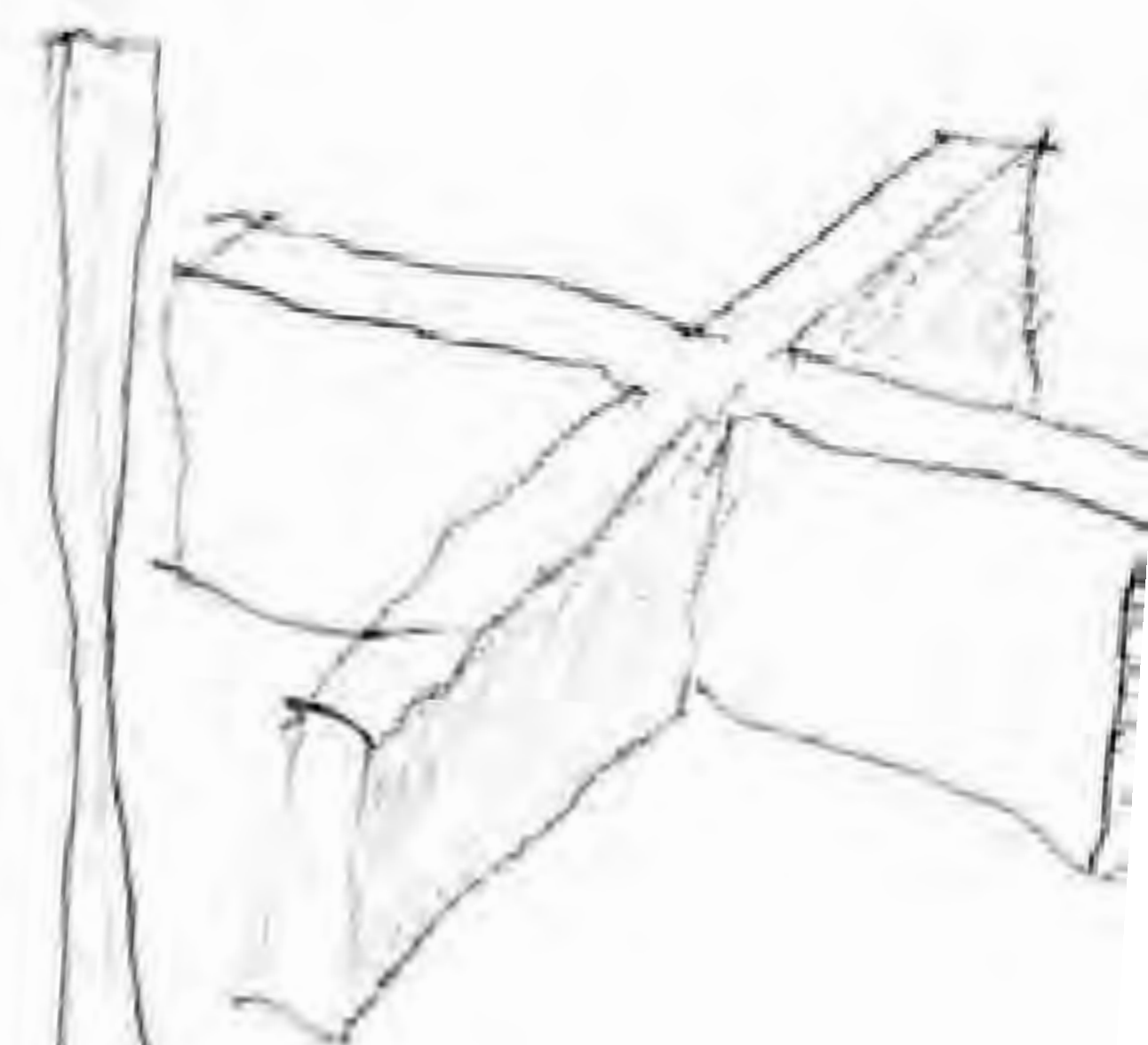

11
60) C. pojuto. 11

M

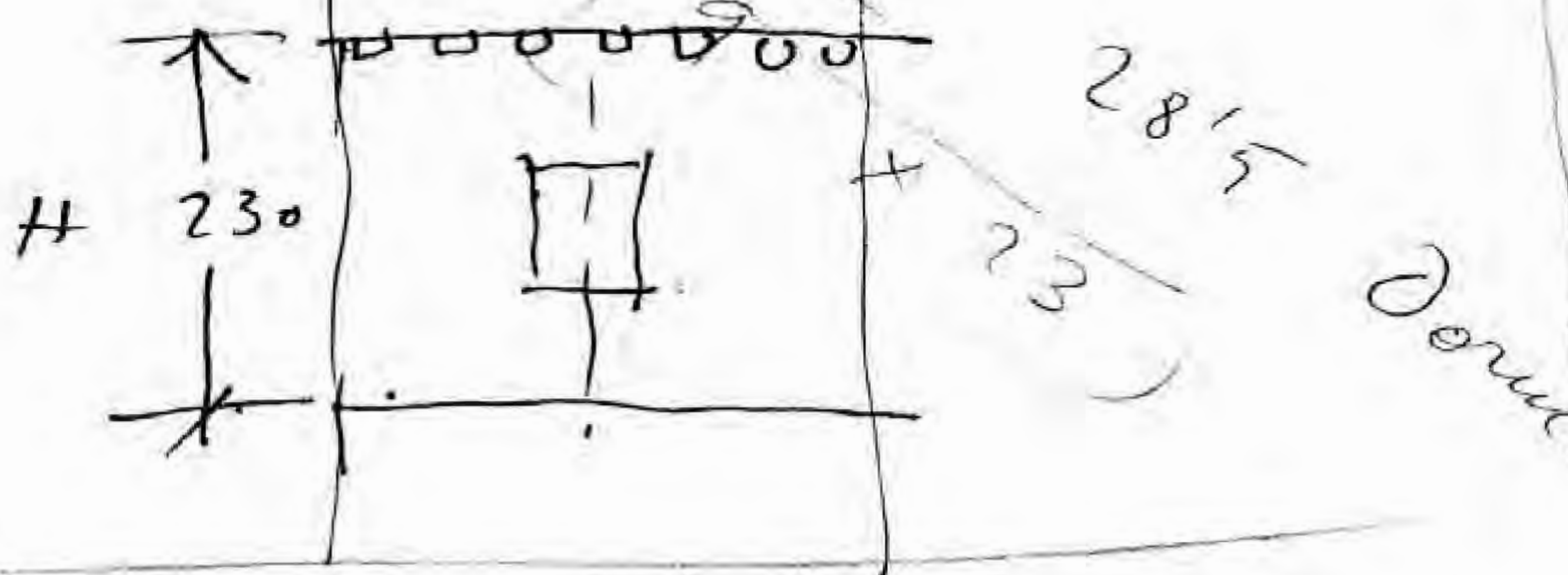
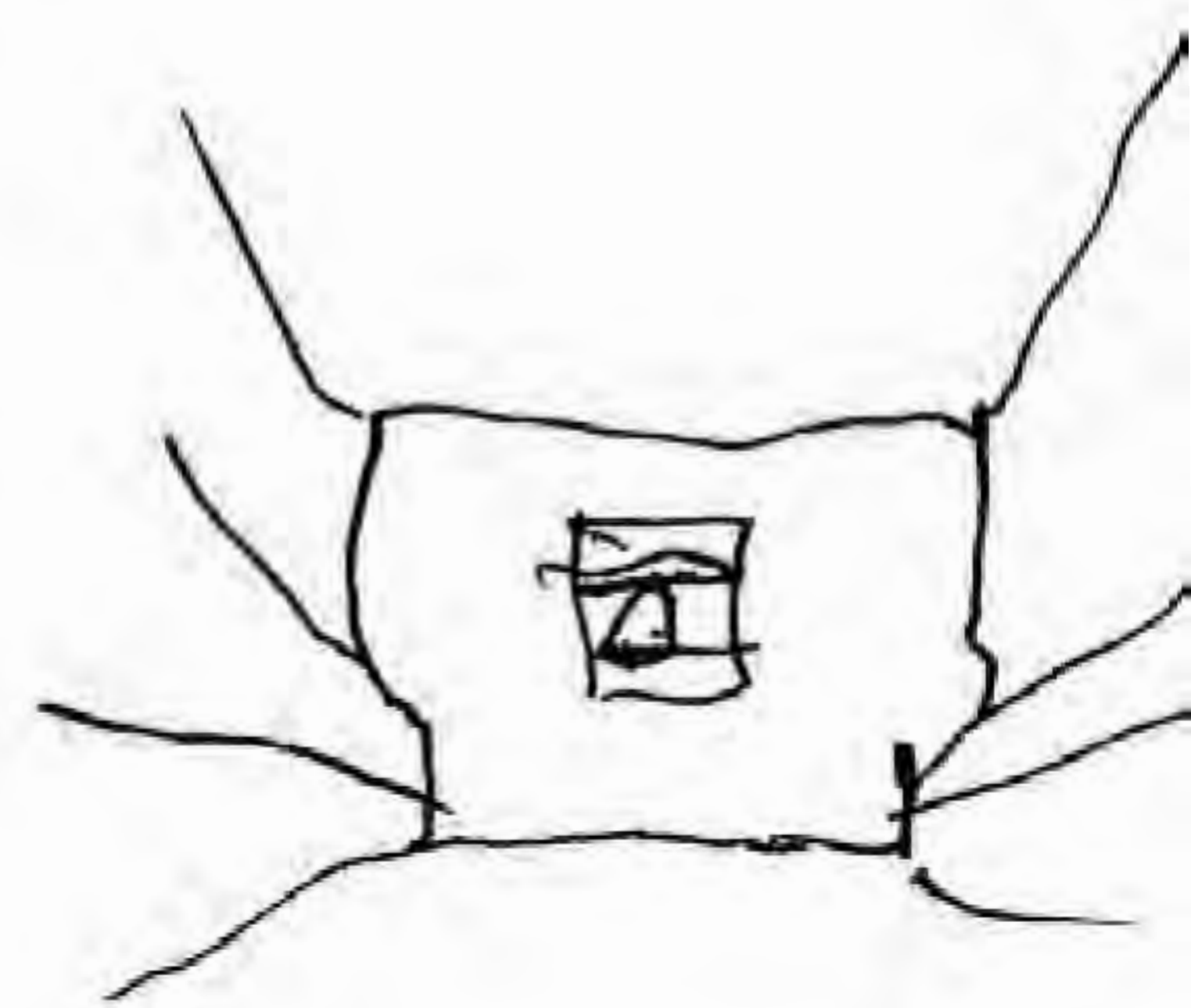
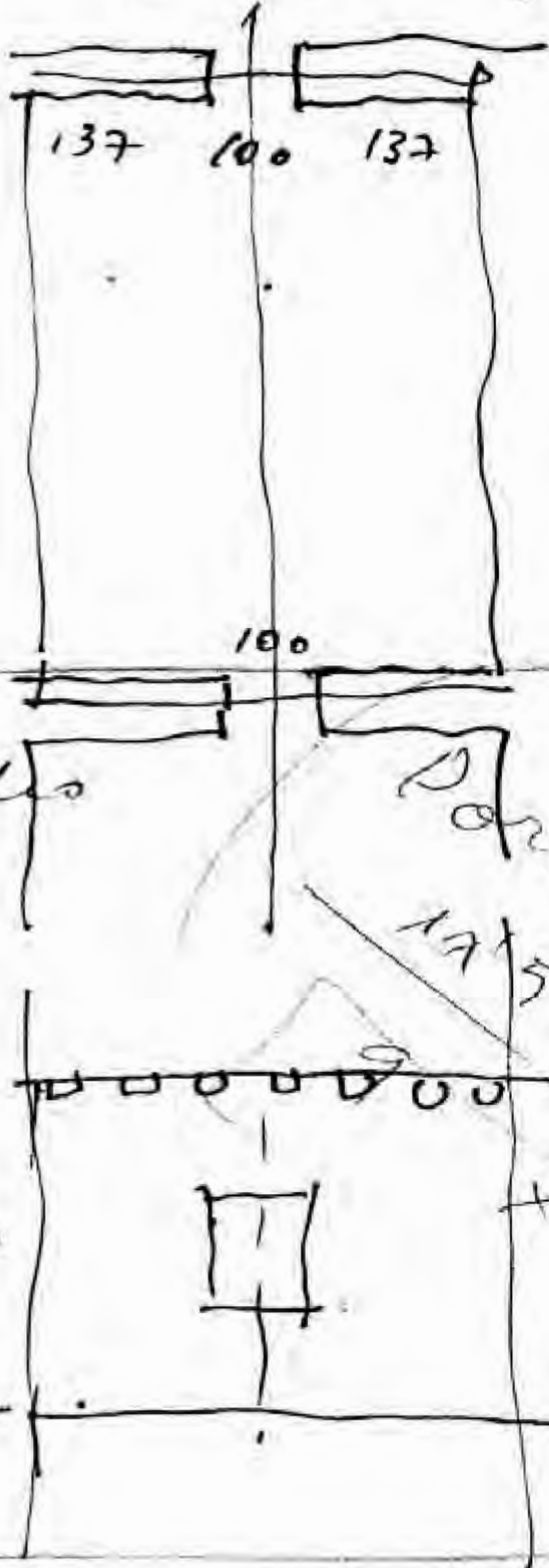
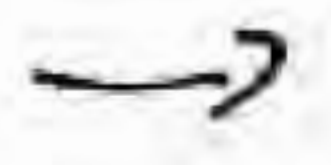
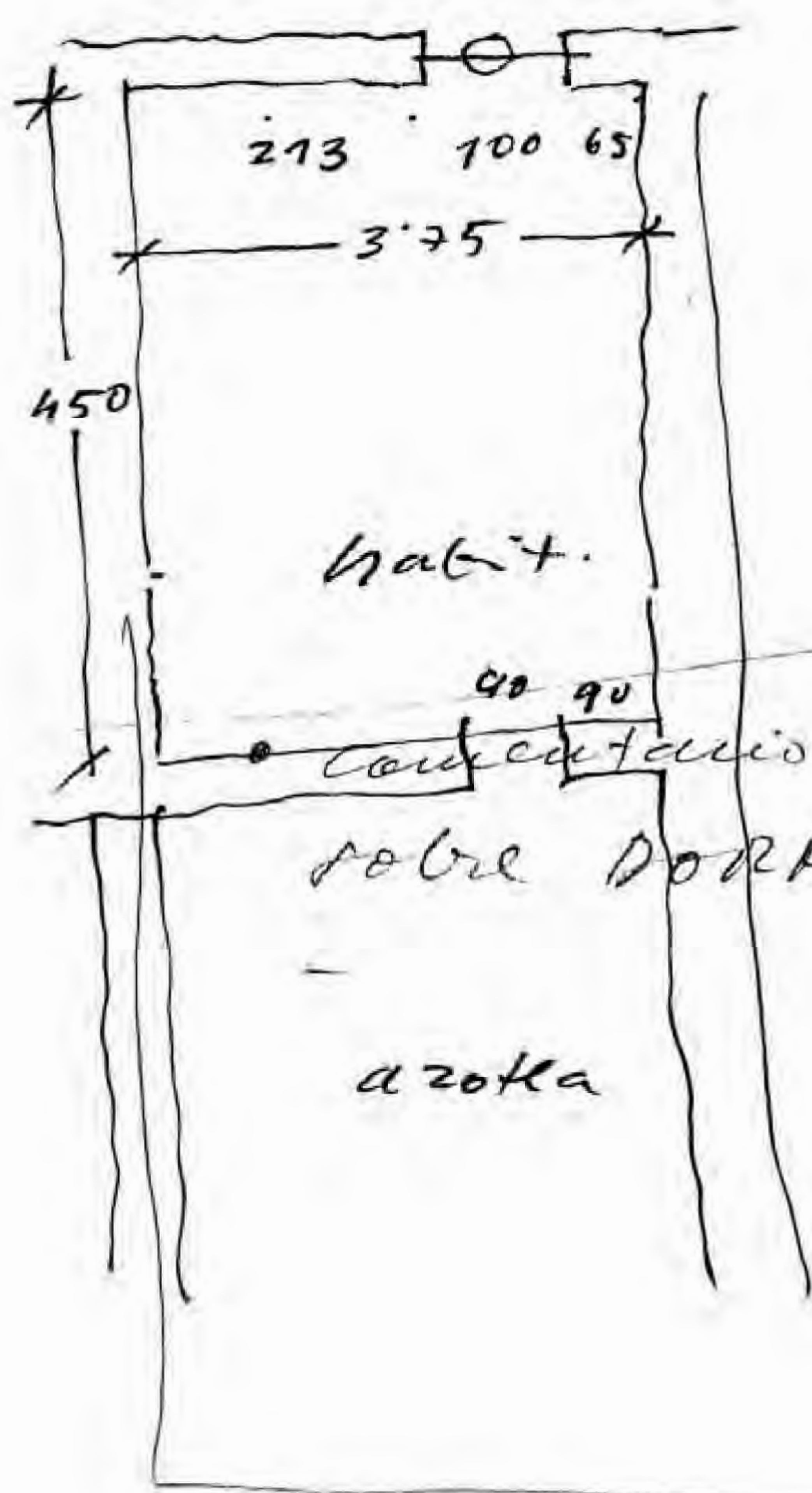

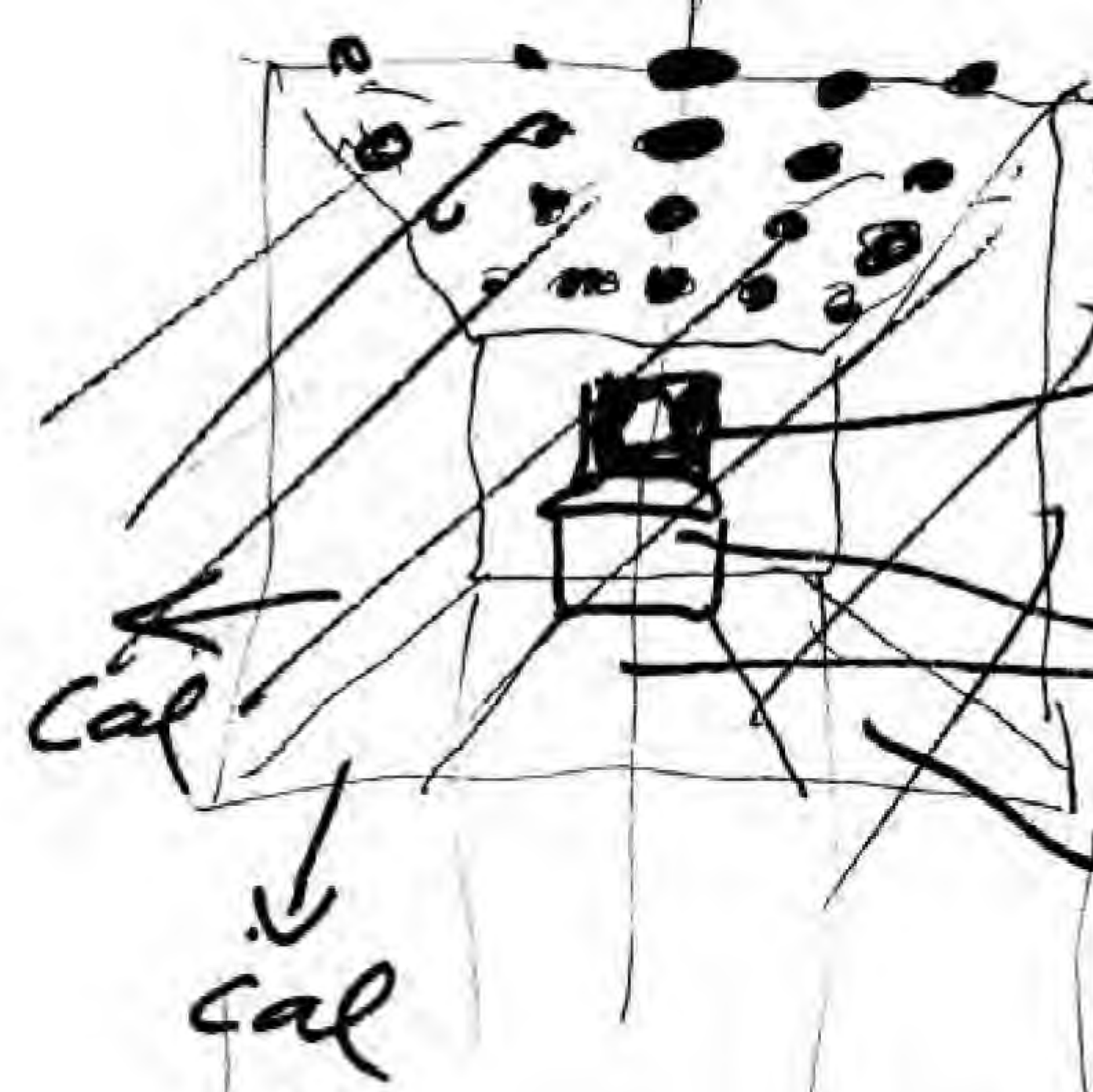

← u1 (mercurio)

→ u2 (ventana + campana)
+ i jazmín?

→ agua (reflejo).

→ mármol blanco (fólo tira central
+ incienso (pebetero)
+ agua (pila.

(Columbarium)

Γ int. del cad.

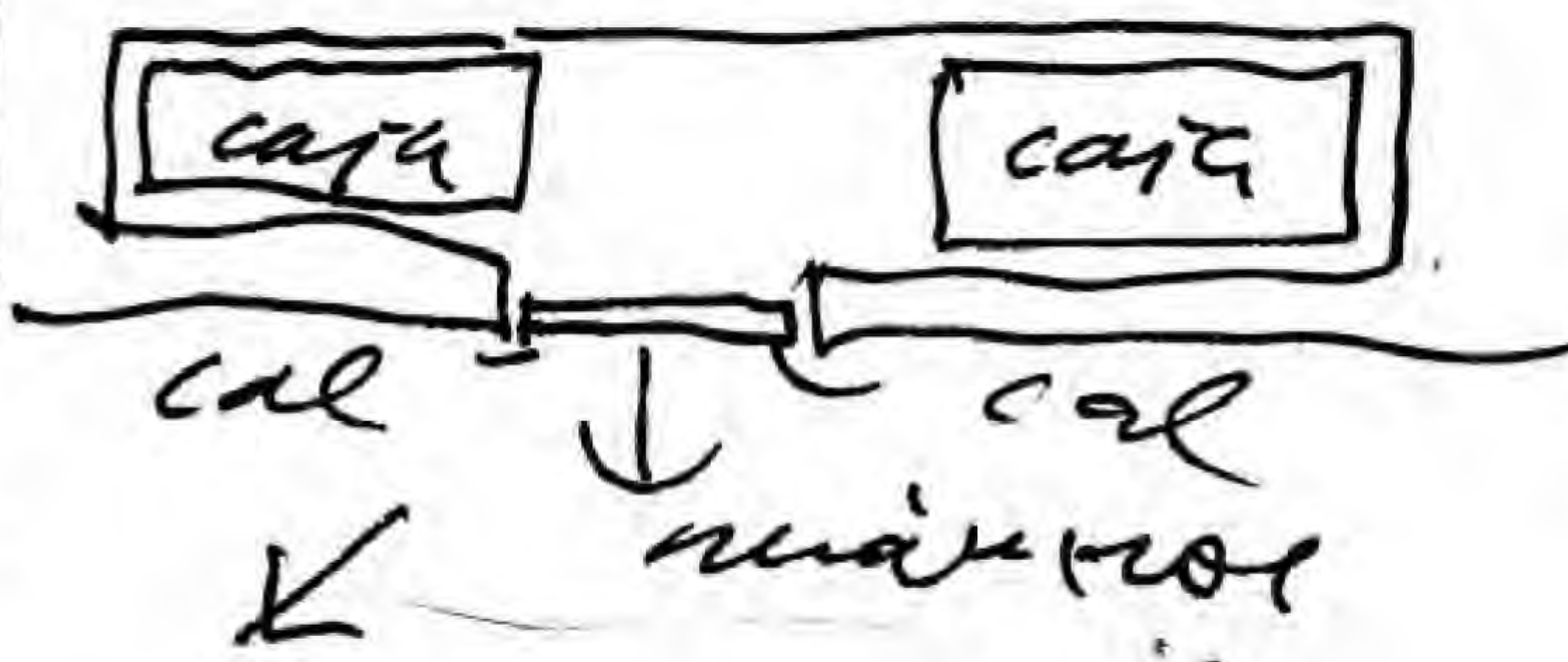

> flores
> luces.
↓
pequeños
vidrios
de plbo.
(6 cajas
del petri)

terminero ↓
puerta de
vidrio?
mármol?



• 1 de nov. todo luces y flores.
• el día de san M. 1 u2 1 flor.

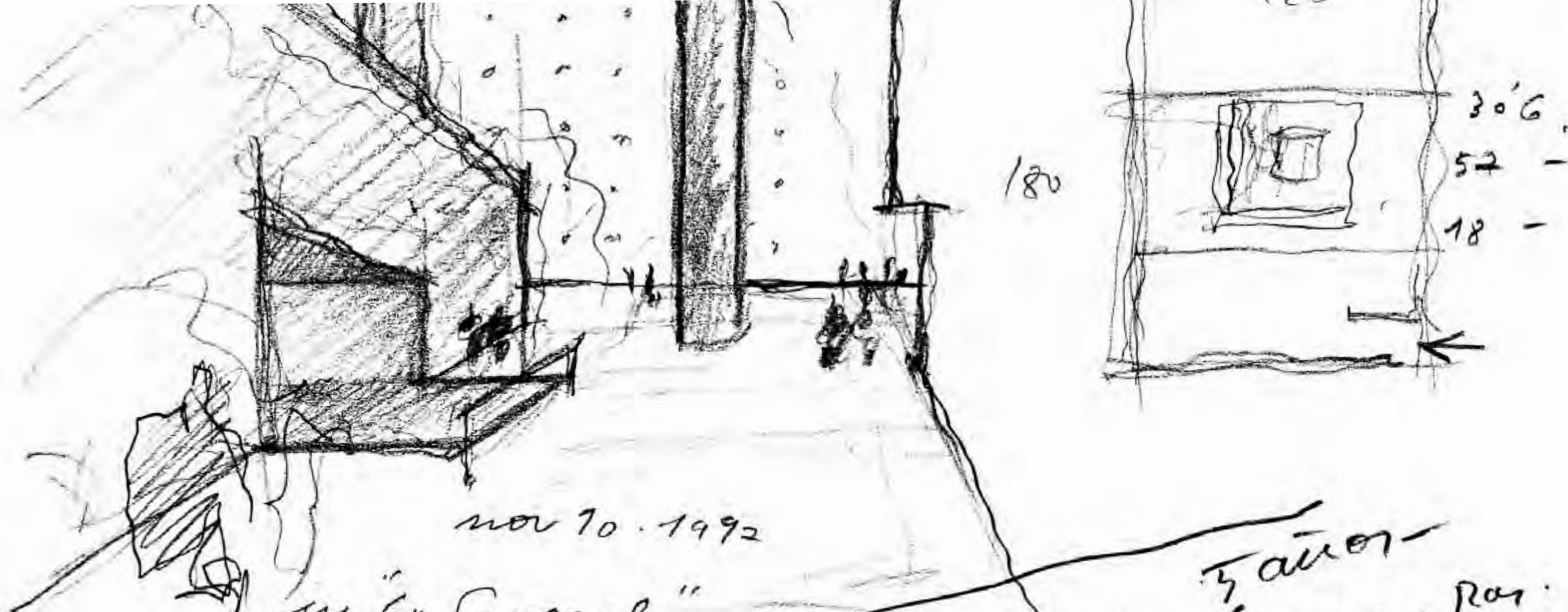

nov 70 - 1992

en "General"

taljib

en POSITIVO ^{yo le dado que} lo mejor ^{enfo} 5 años
 27. → (3200 + 6100) var

SIMULA

- **FUNCIÓNALMENTE** - esqumay • Ha ^{Fur}
- **CONTEXTUALMENTE** - la de Bossard ^{For}
 concurs - cantera (mutuamente) ^{Carl}
 - seguridad ^{Sant}
 - PGOV ^{pero}
- **URBANÍSTICAMENTE** - título 2 ^{• Jose L}
 - punt. al PGOV ^{Jaco}
- **RIGOR** ^{frente a tanta frivolidad}
- **BENEFICIA** ^{• no frívolo ni a vint. (Granada)}
 • la catedral de G ^(P. Salmerón)

en lo tiene al fin
 en woodvil.

November 10. 1997



UES.
LCC 60 18
DTE

my

120

60 18
62 — 57 3 60
— — — 6 —
54+3

27.500

14.000

6+7.

7 no computan
(archivos.
aparatos).

1 cada 5/.

63 18 54 3 60
+3 0
6

180

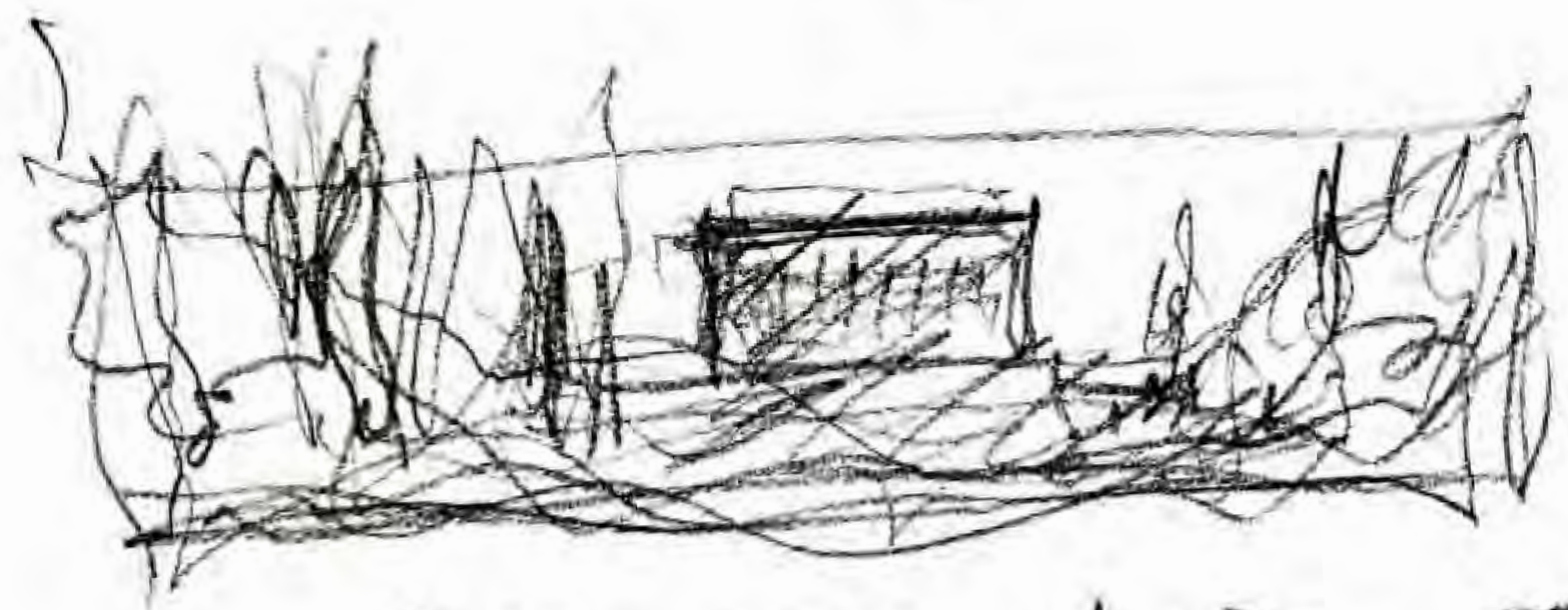

con un indicativo incluido
ya es el momento del encargo de la
red. del pro. básico ya de ejecución
↳ licencia

— asesores / 70 colaboradores —

Normas del Consejo S. de C. de Arquitectos
de España Olea / Martín.

Banajás. centro de salud para
Londres-Dublin.

el 3 diciembre 1997.

a las 16:25 / -

MAD-LON-DUB ..

December 3. 1997

Jury. (After seeing the tapestry.
There is a grid.

a frame.
a structure.

1100 Bowel ruin

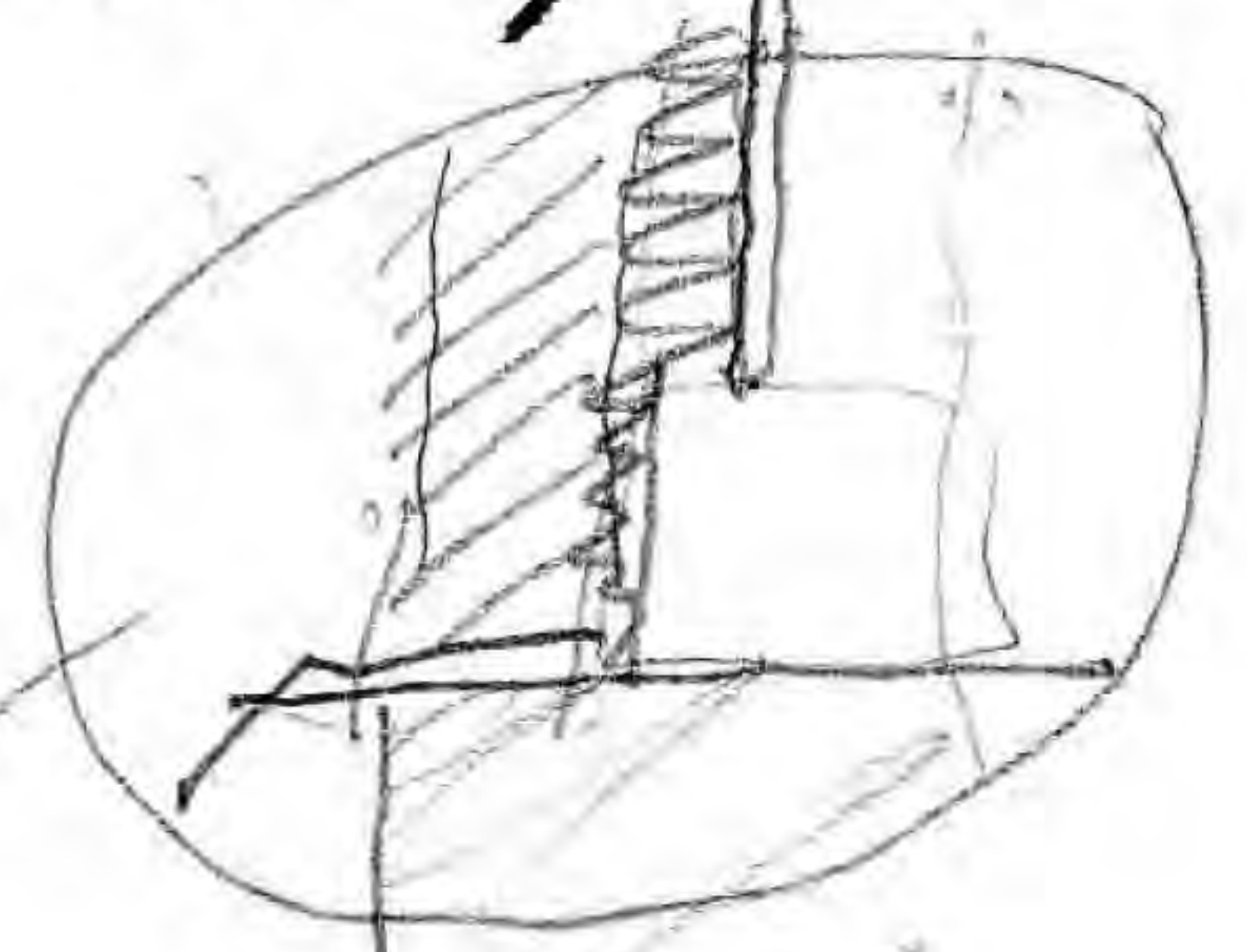

But ^{the} frame only collaborates.

They have been fascinated by this frame.

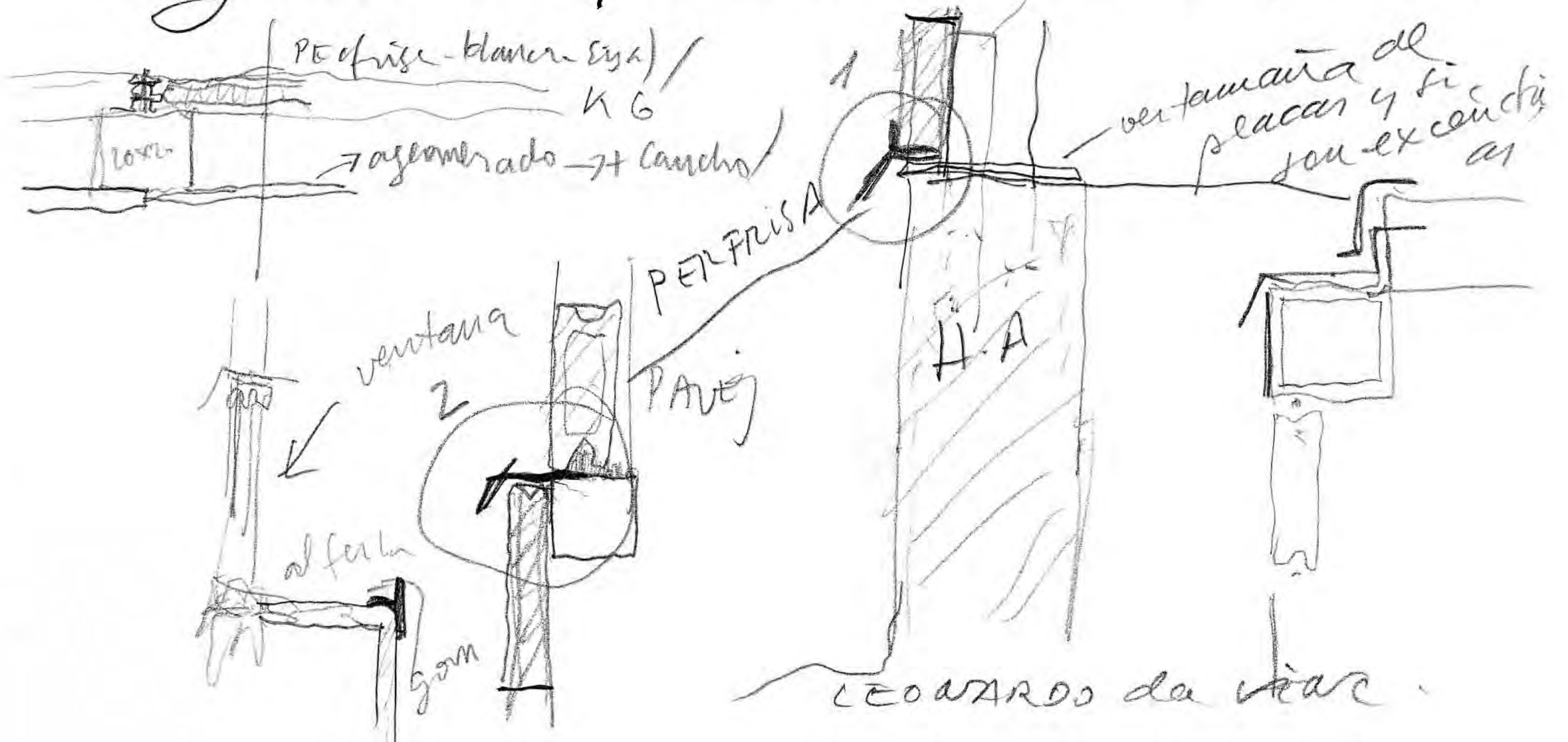

MAM

dec. 3. 92

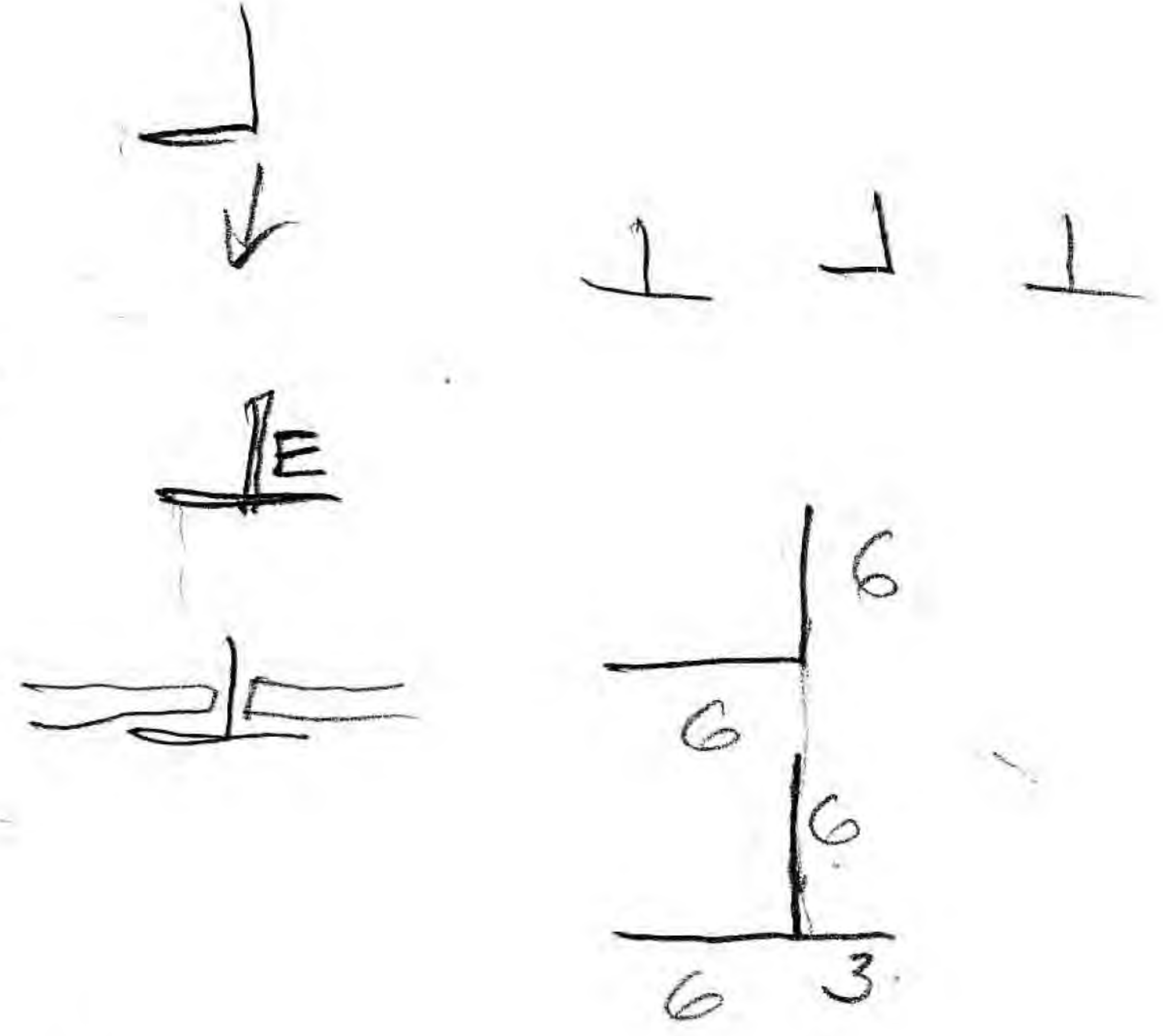
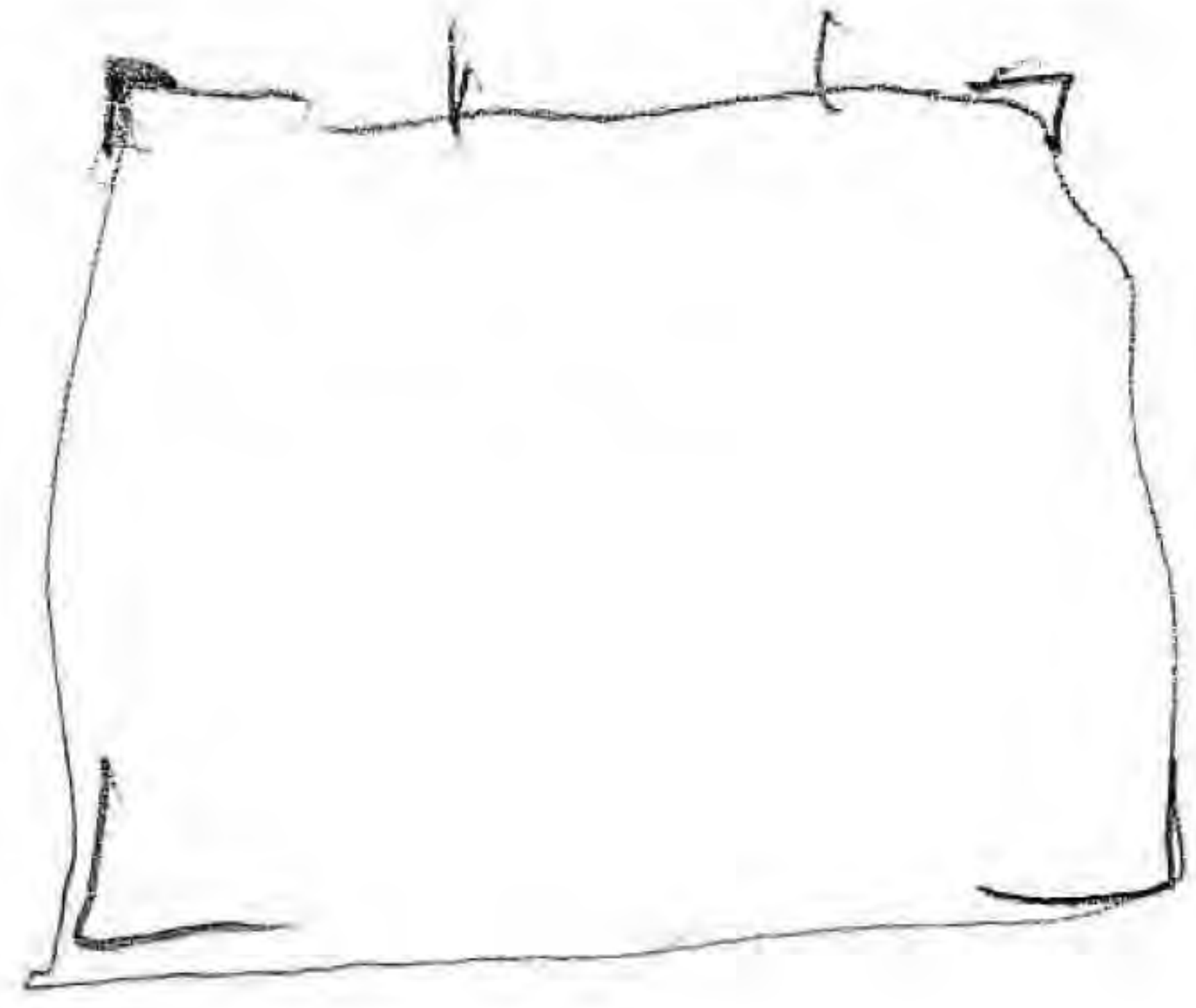
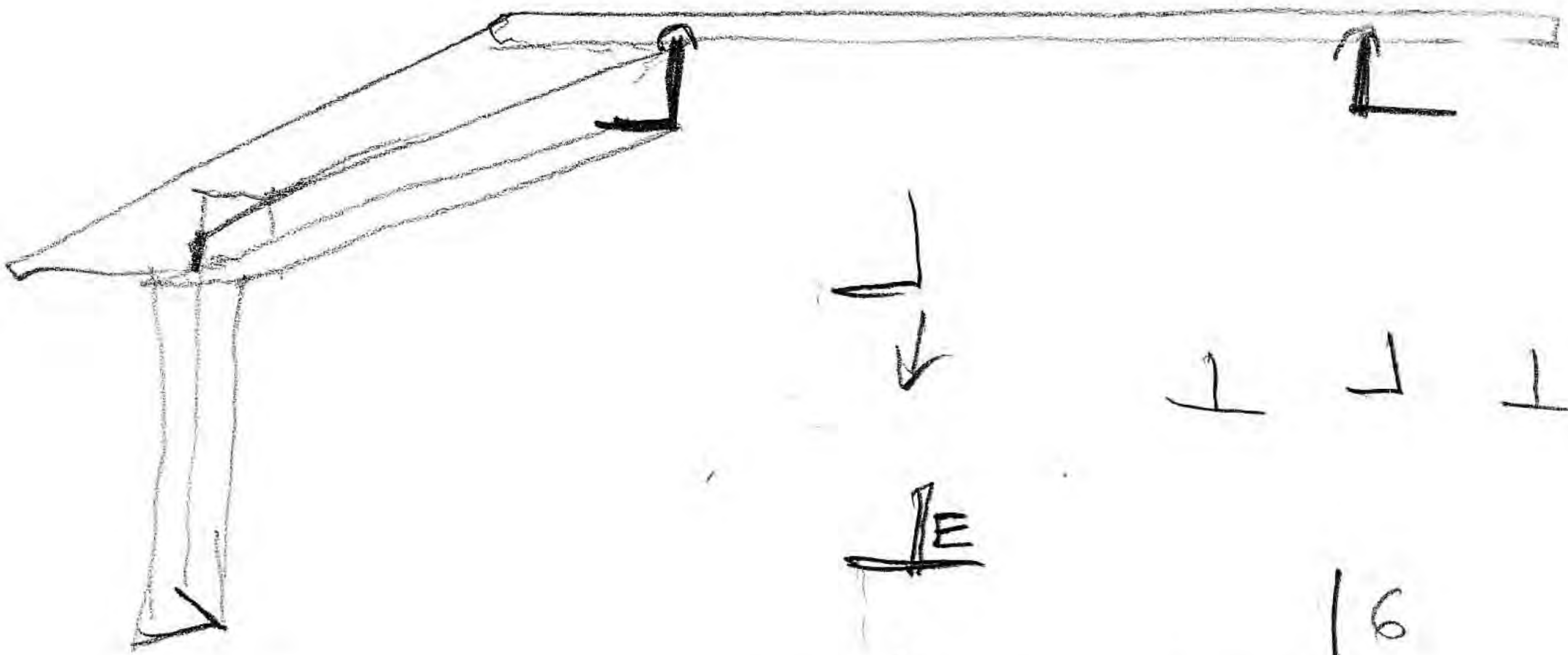
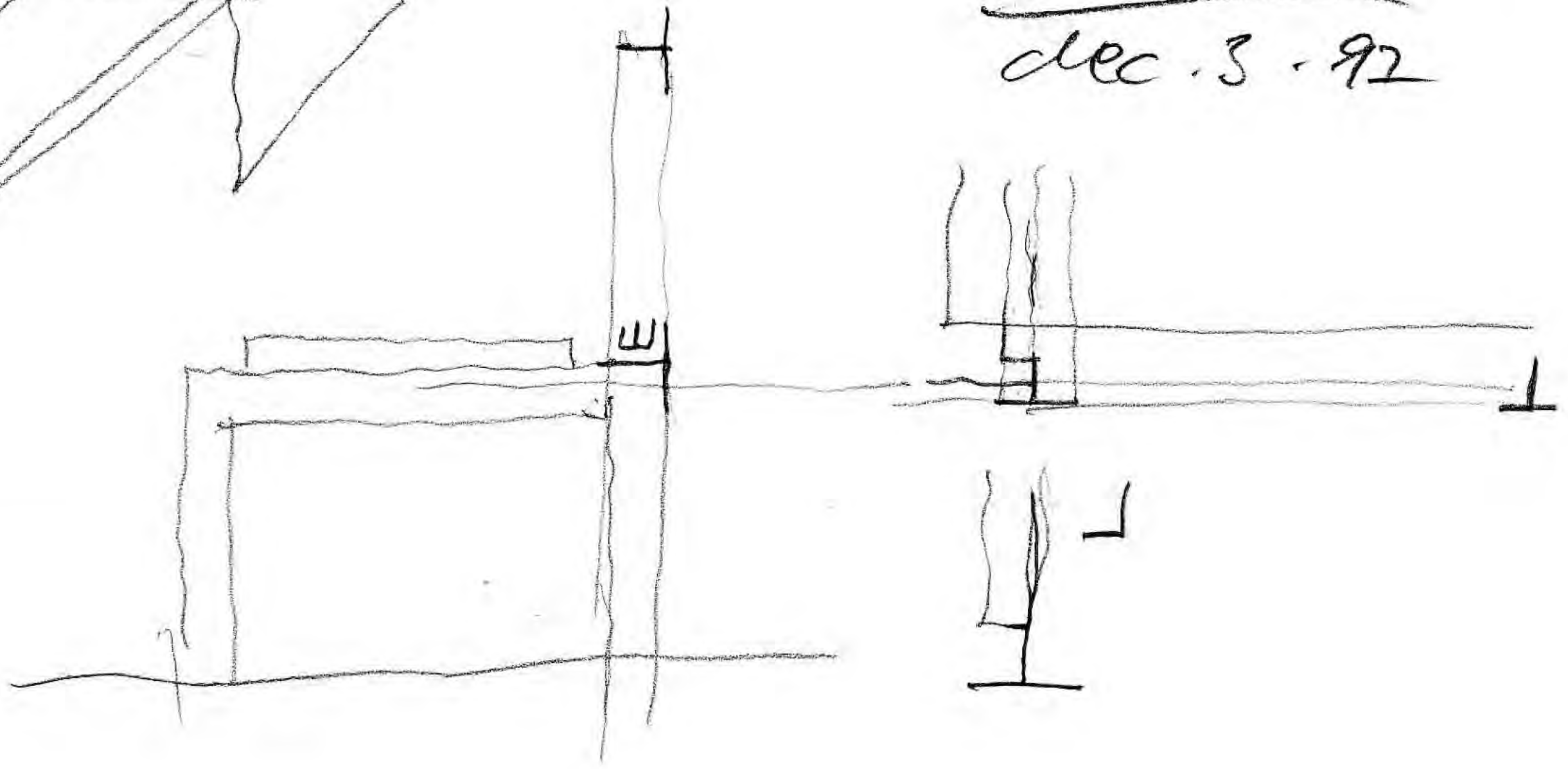
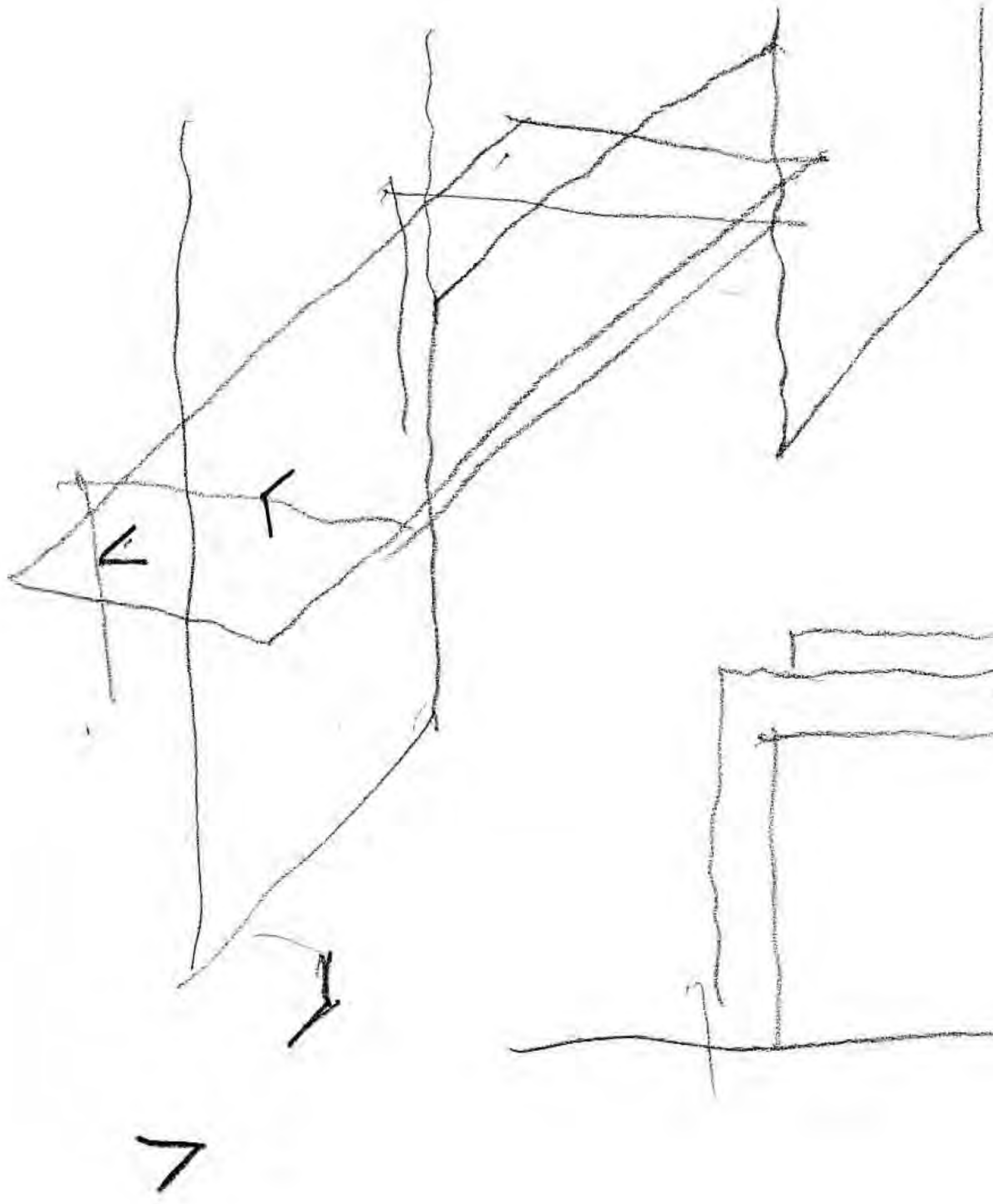

ver con N+D.
 el 9. de dic de 1992
 se pasan.

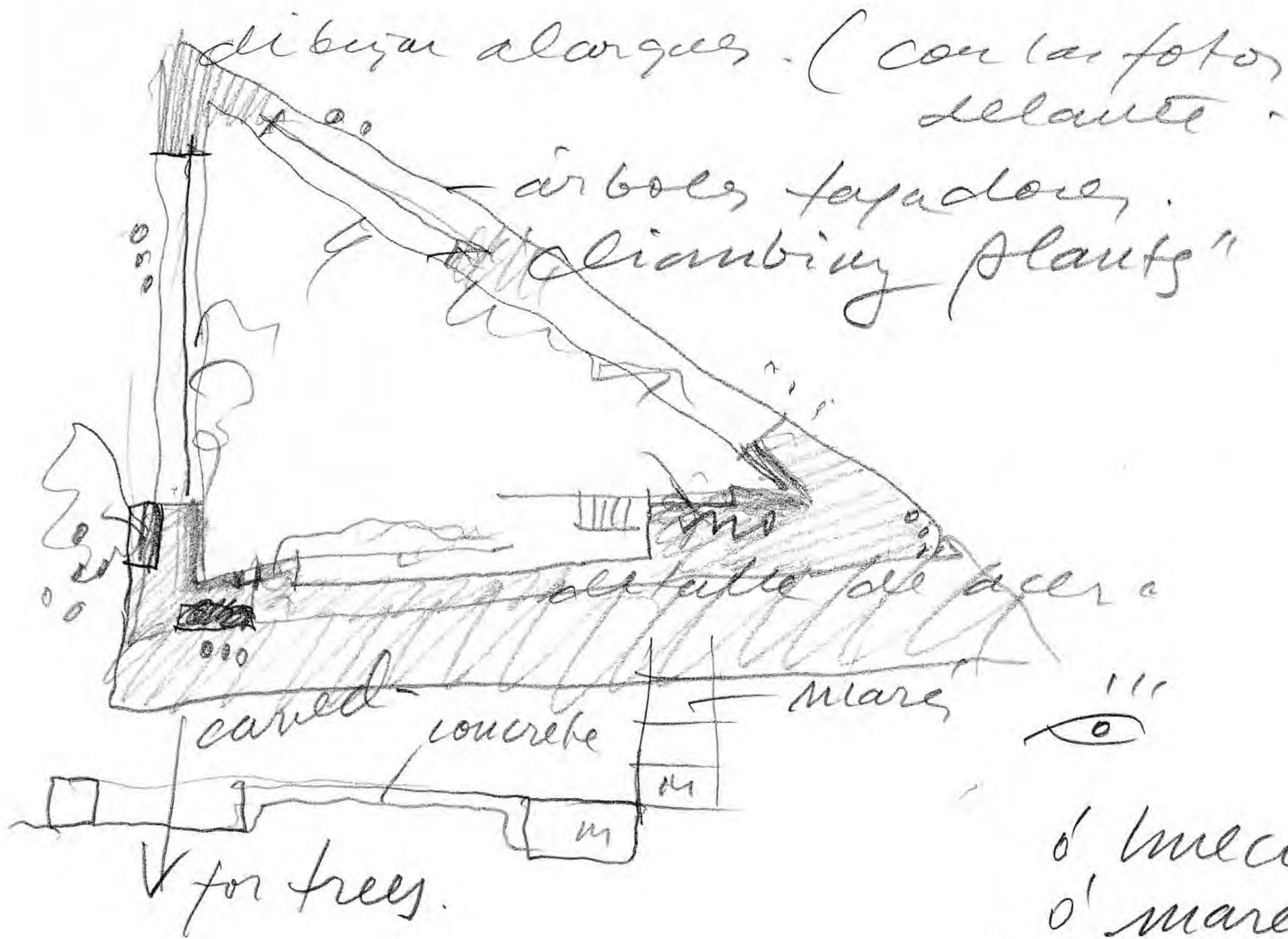

o' meco
 o' marés

> medida de la
 piso. en la entrada

el resto, como son
 bandido

I am just now waiting for my flight
 EI 177 (Air Lingus.)
 19 45 gates 82-90
 no gate! (22 D)

COAM

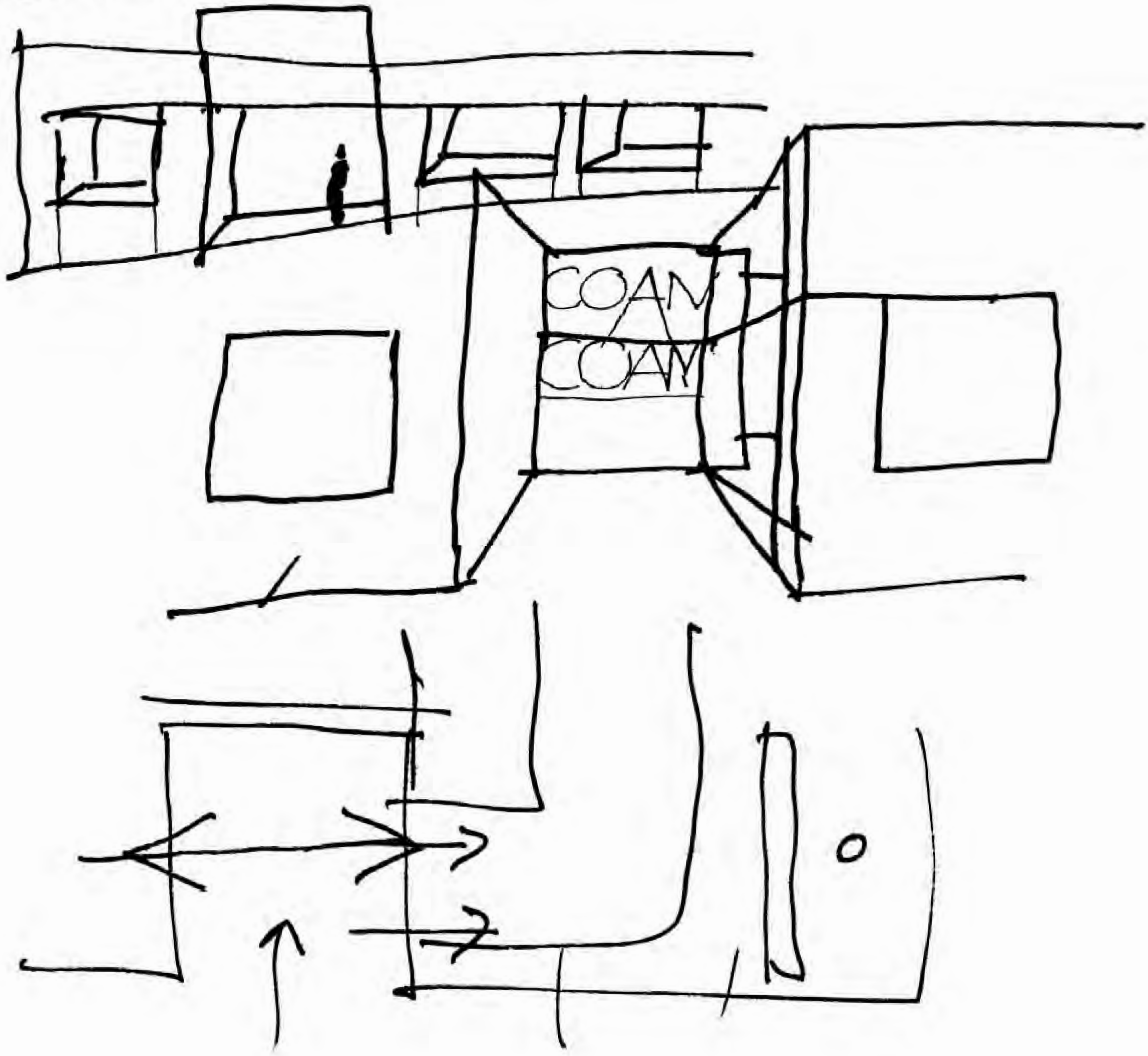

• AMERICA Stone.

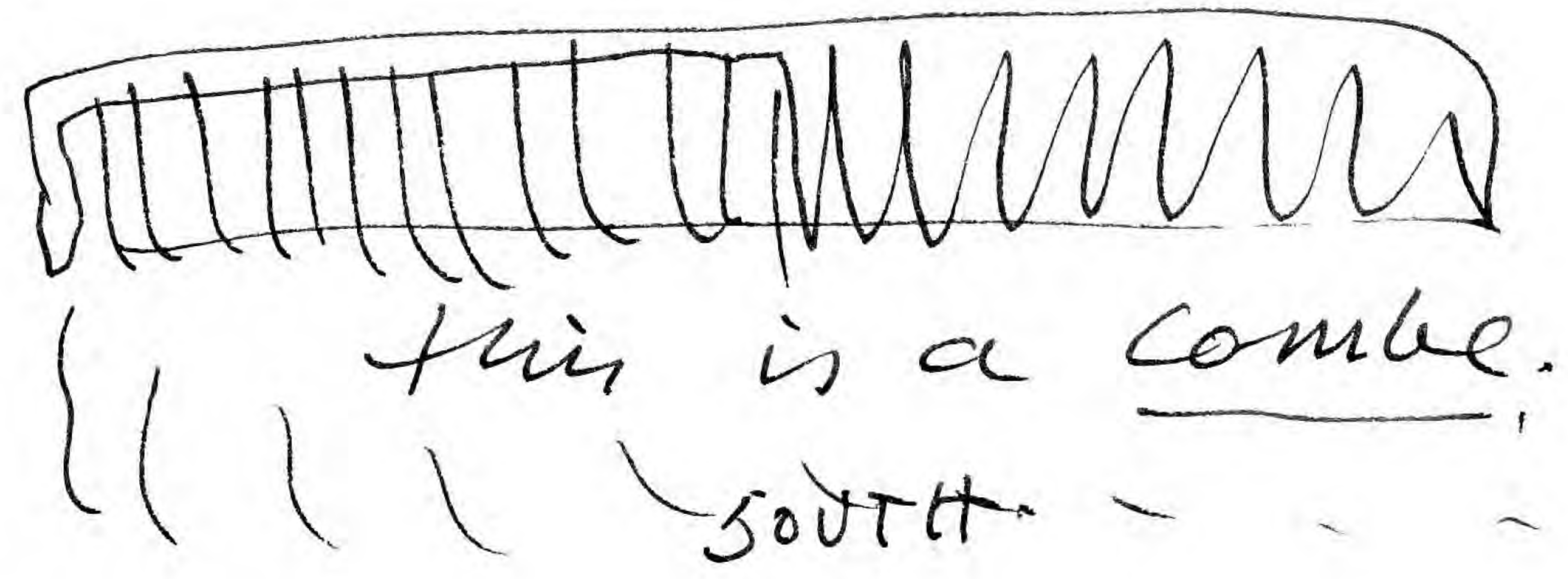
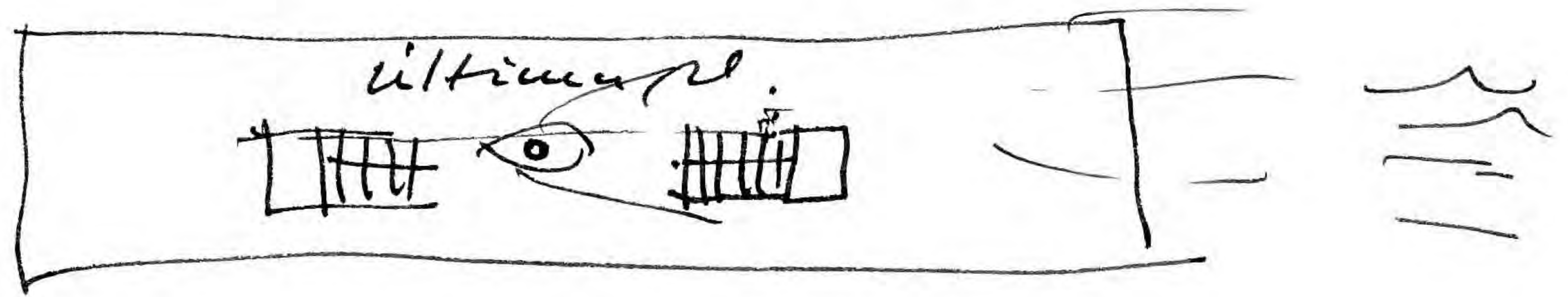
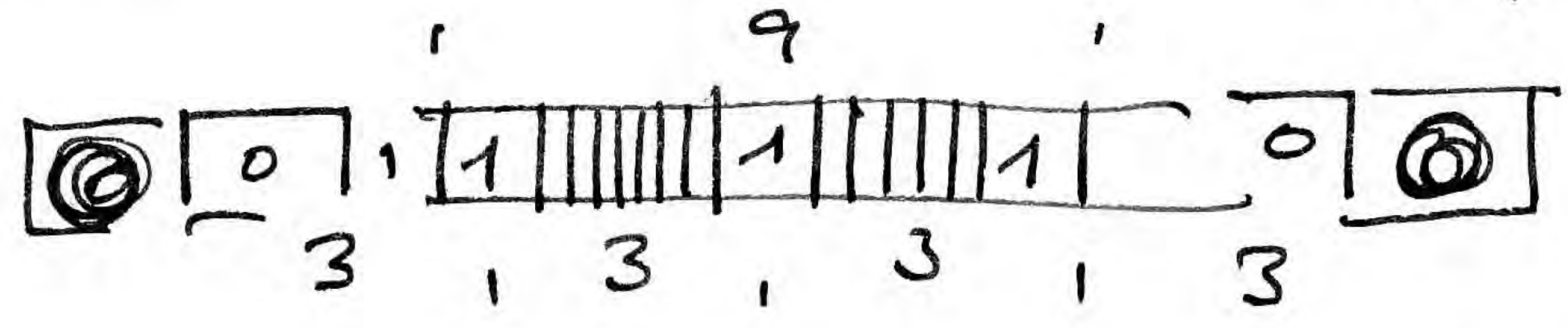
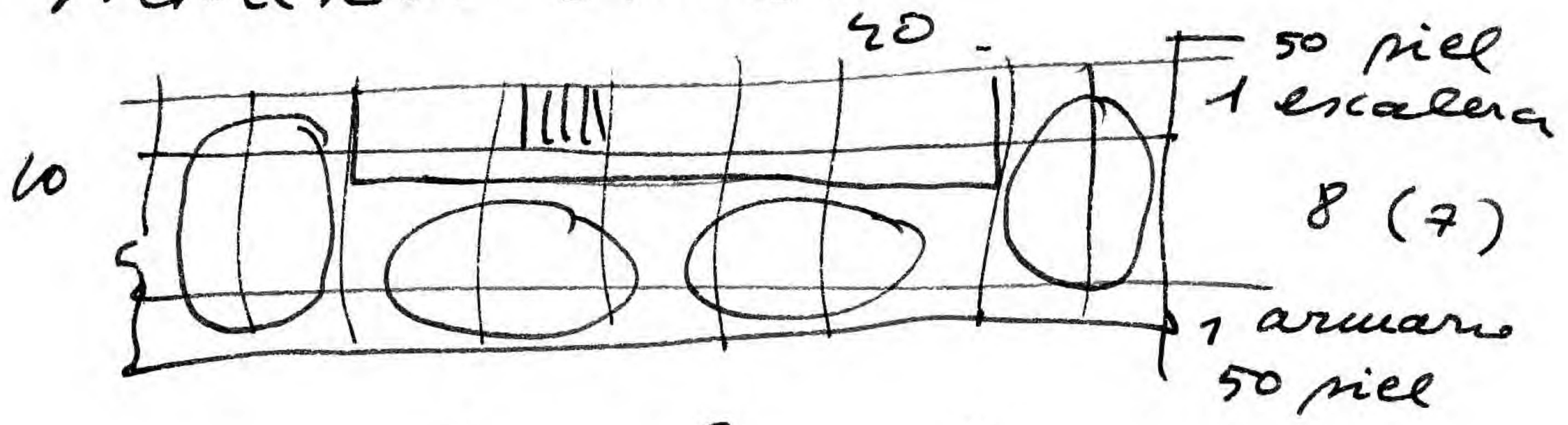

LEONARDO COAT.

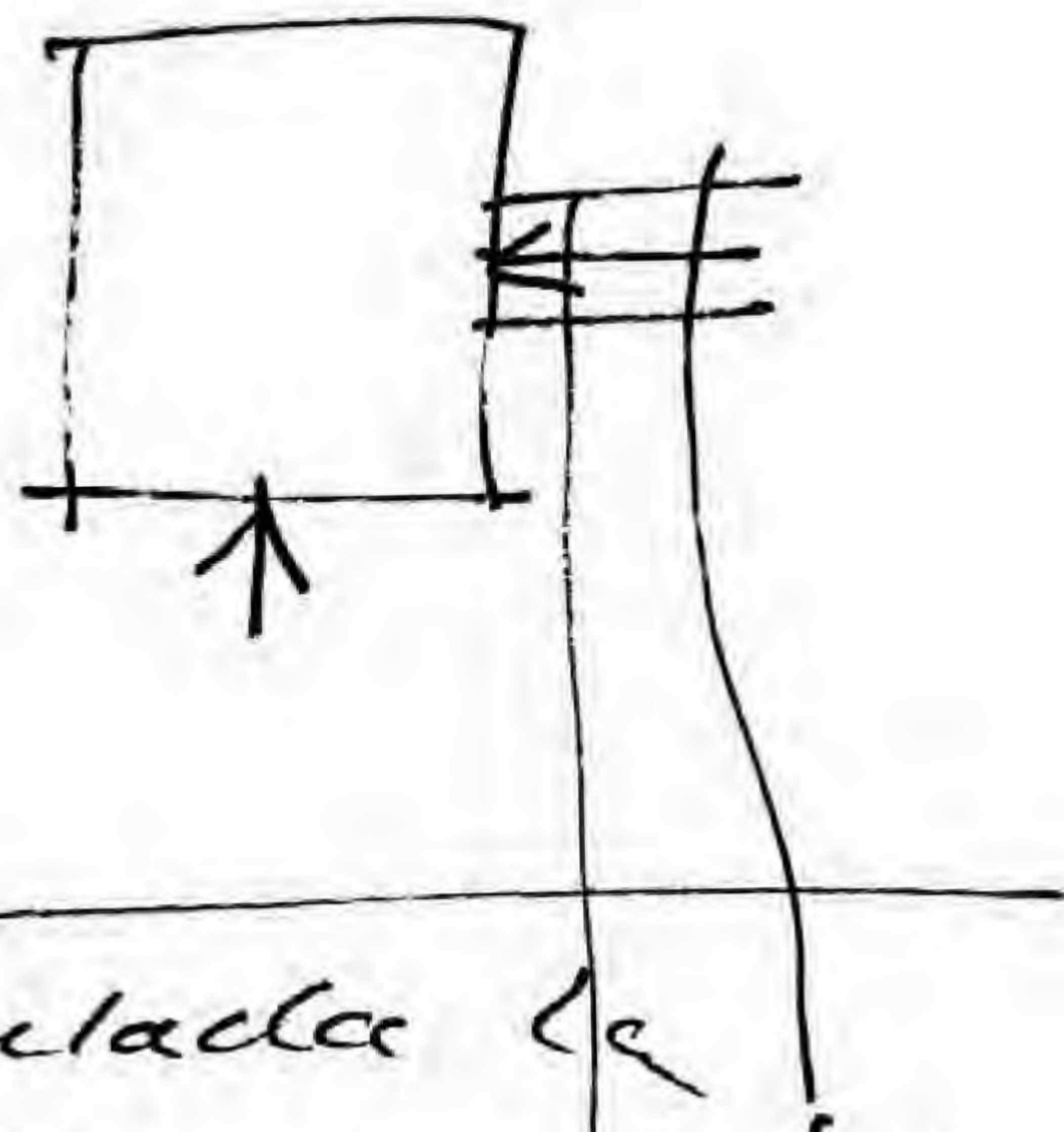
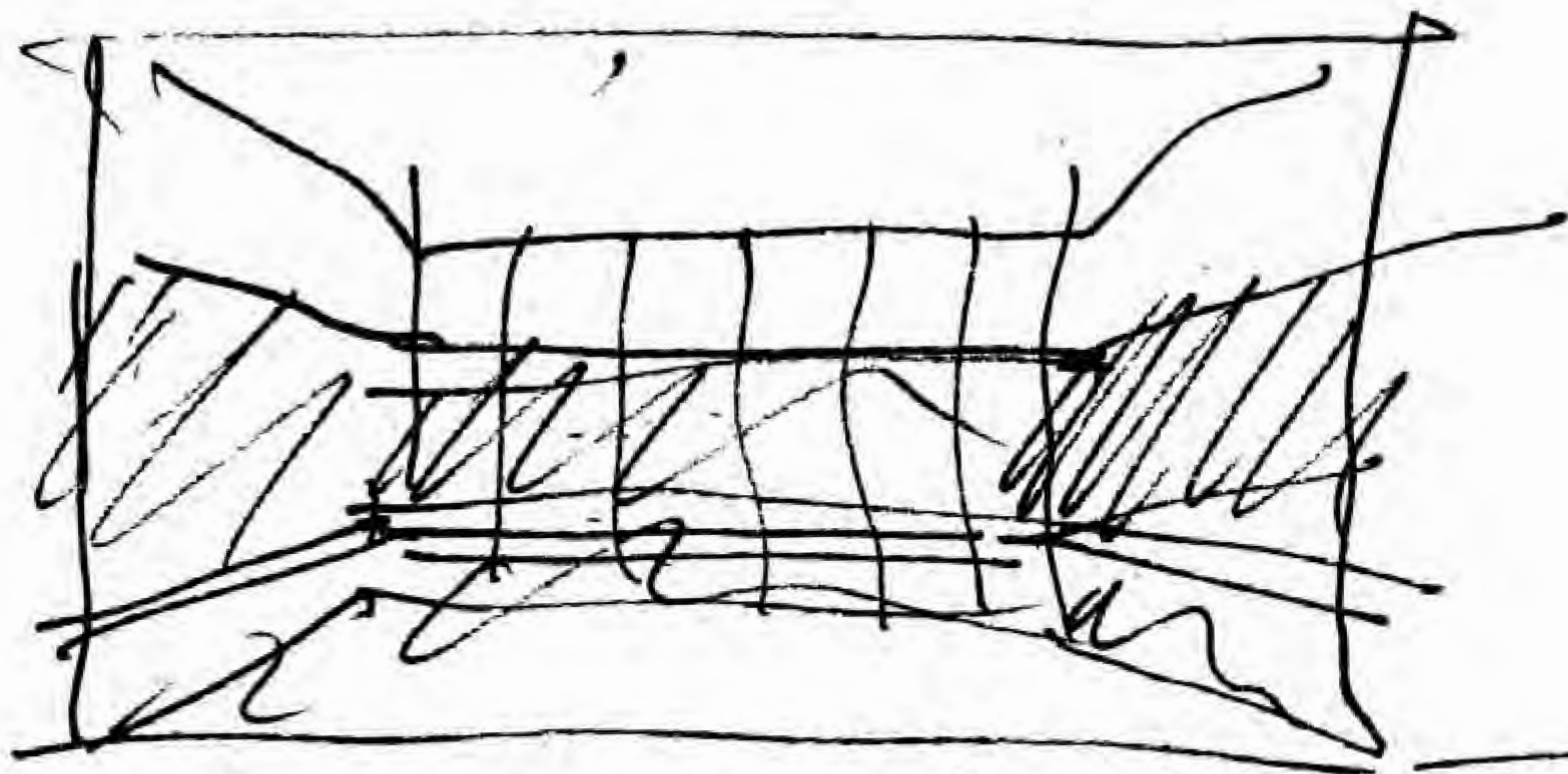

(ver si Andar tenía calculada la solución en emergente). (40 metros h.).

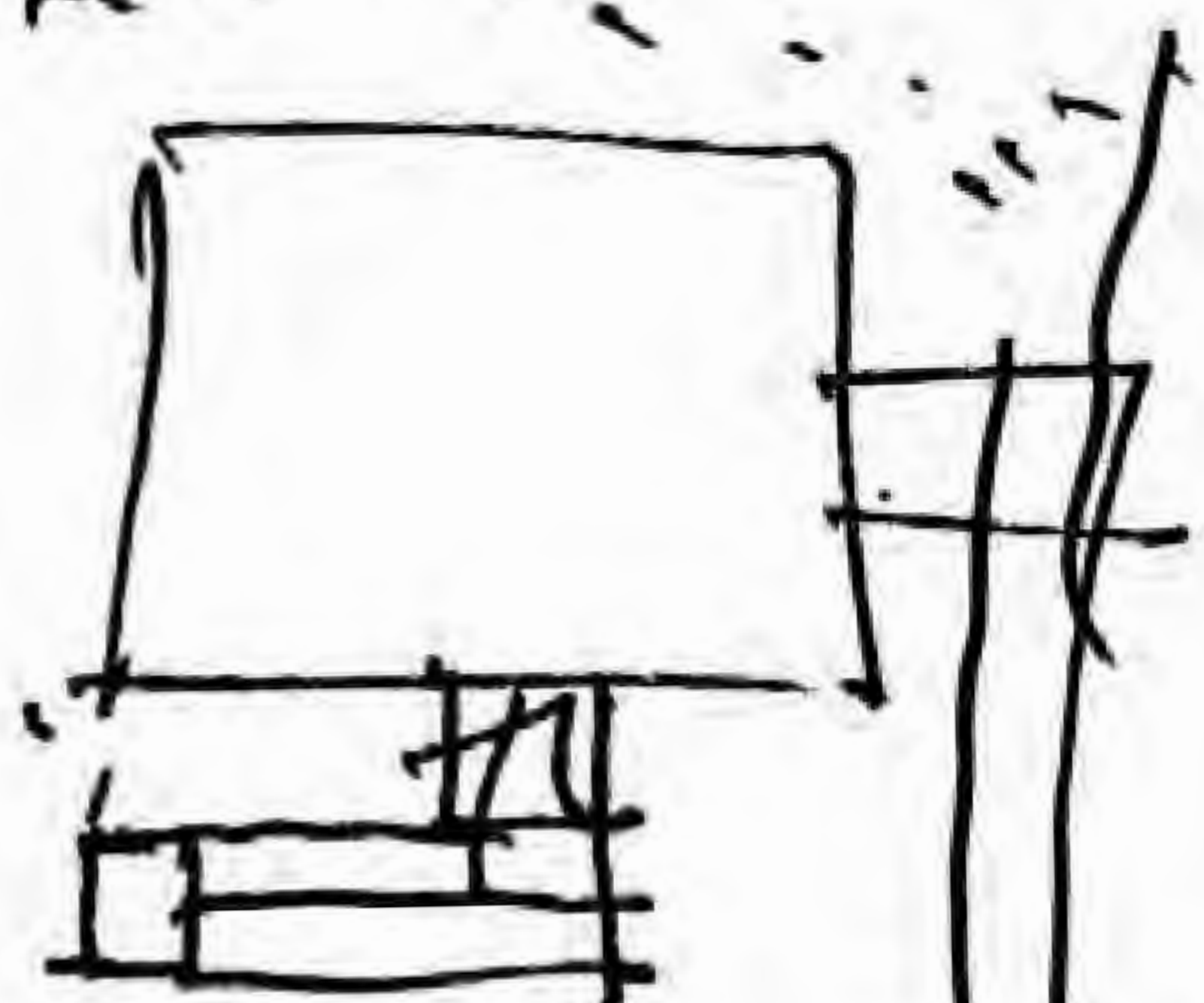

precio | Perfrisa
" goma blanca

PALM. - alcorgue

- 0) uapulta.
- 1) alcorgue.
- 2) cónico y que palmera COLUMNAR planta.

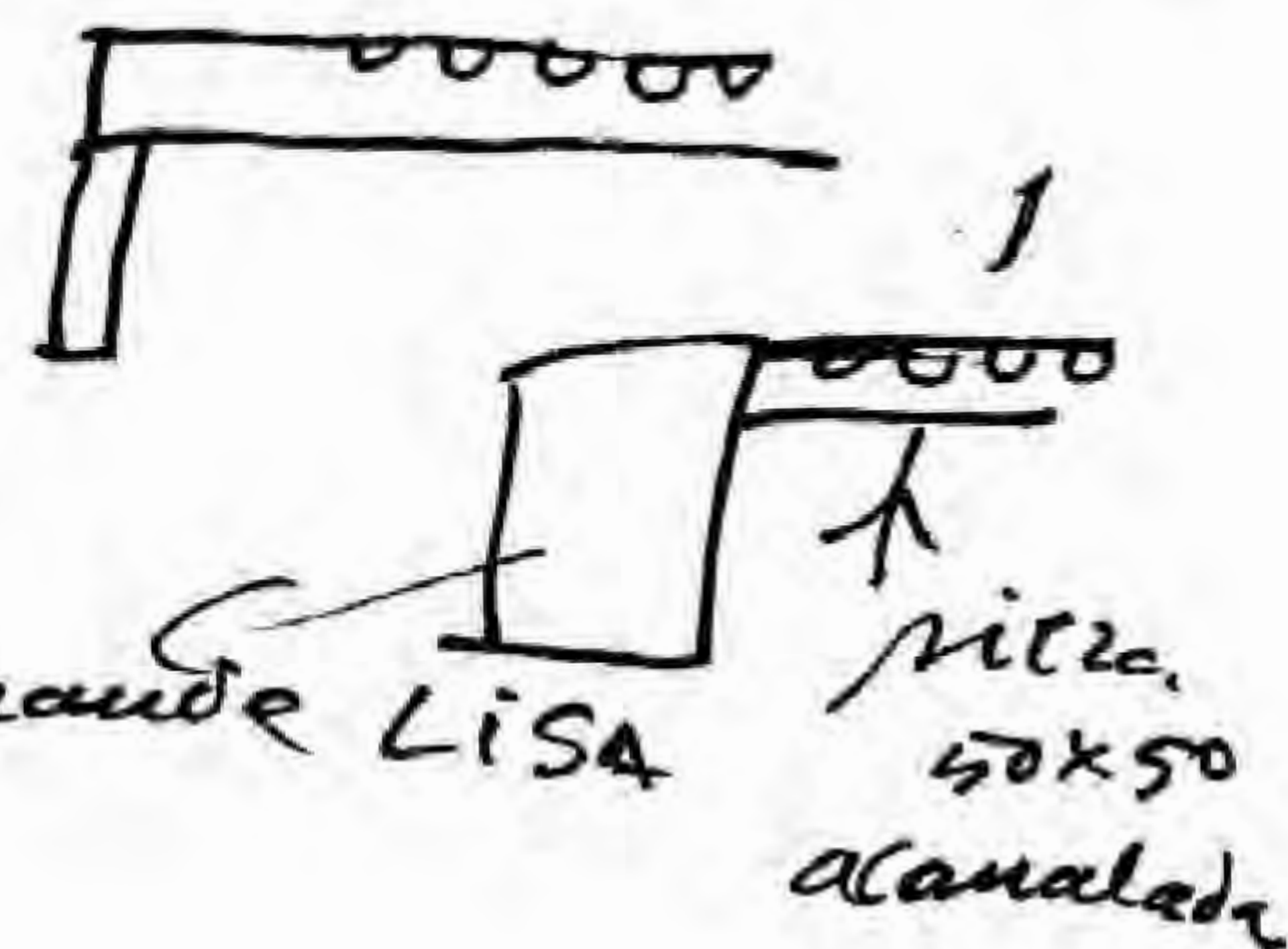

- 3) canto rodado blanco grande

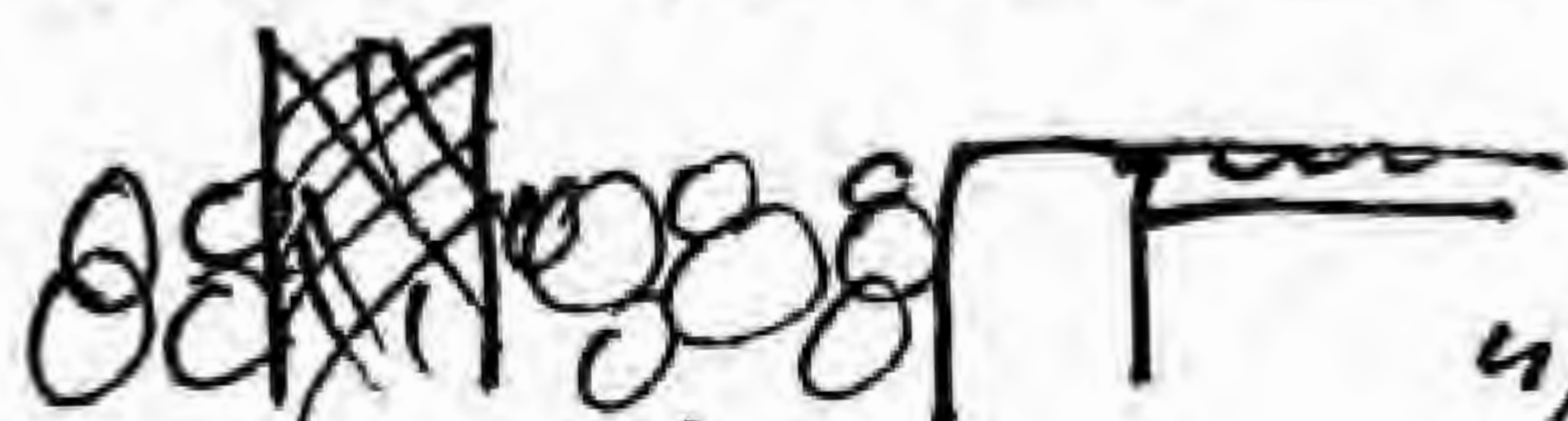

- 4) buendesaie.

• CHICLANA

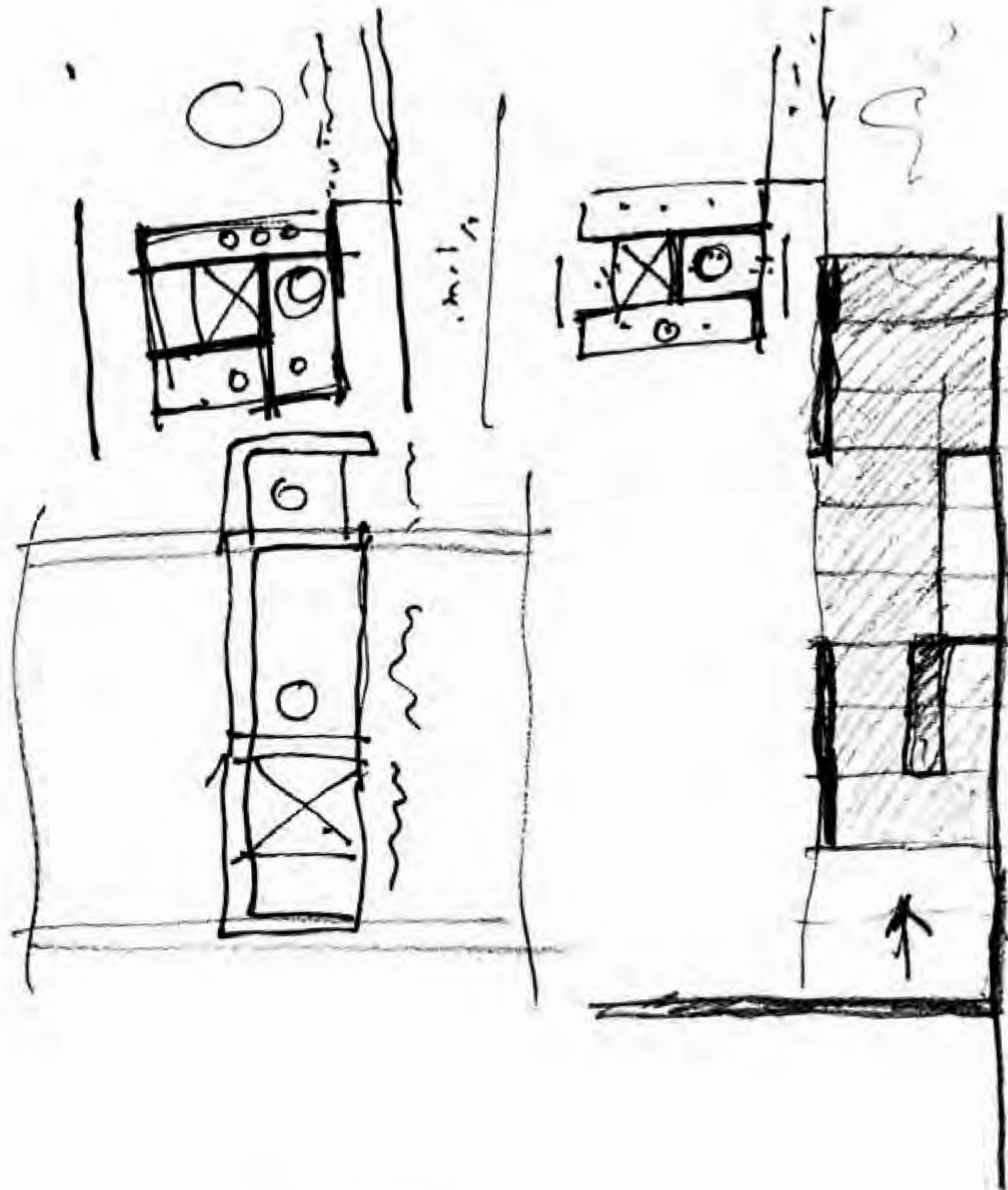
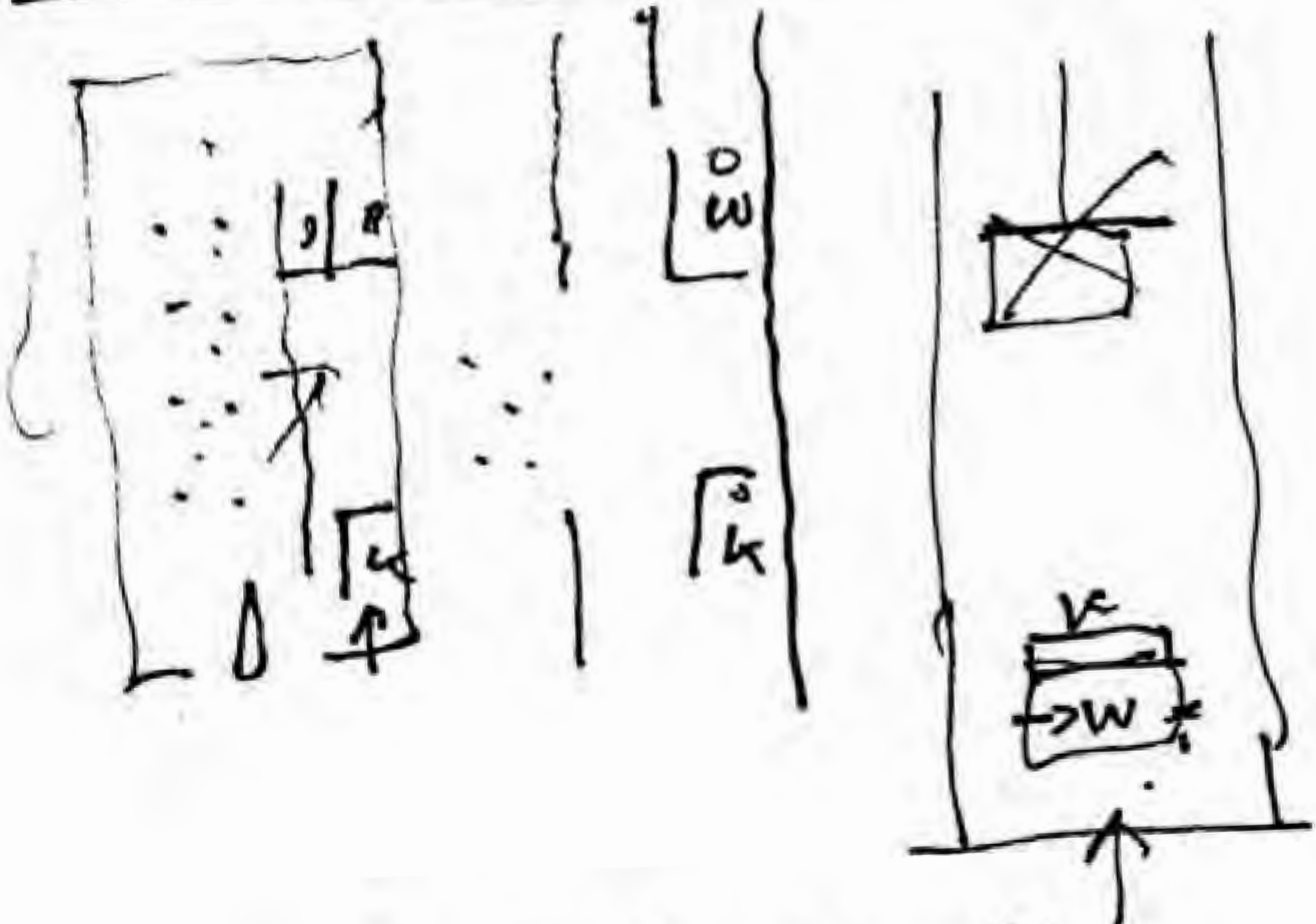
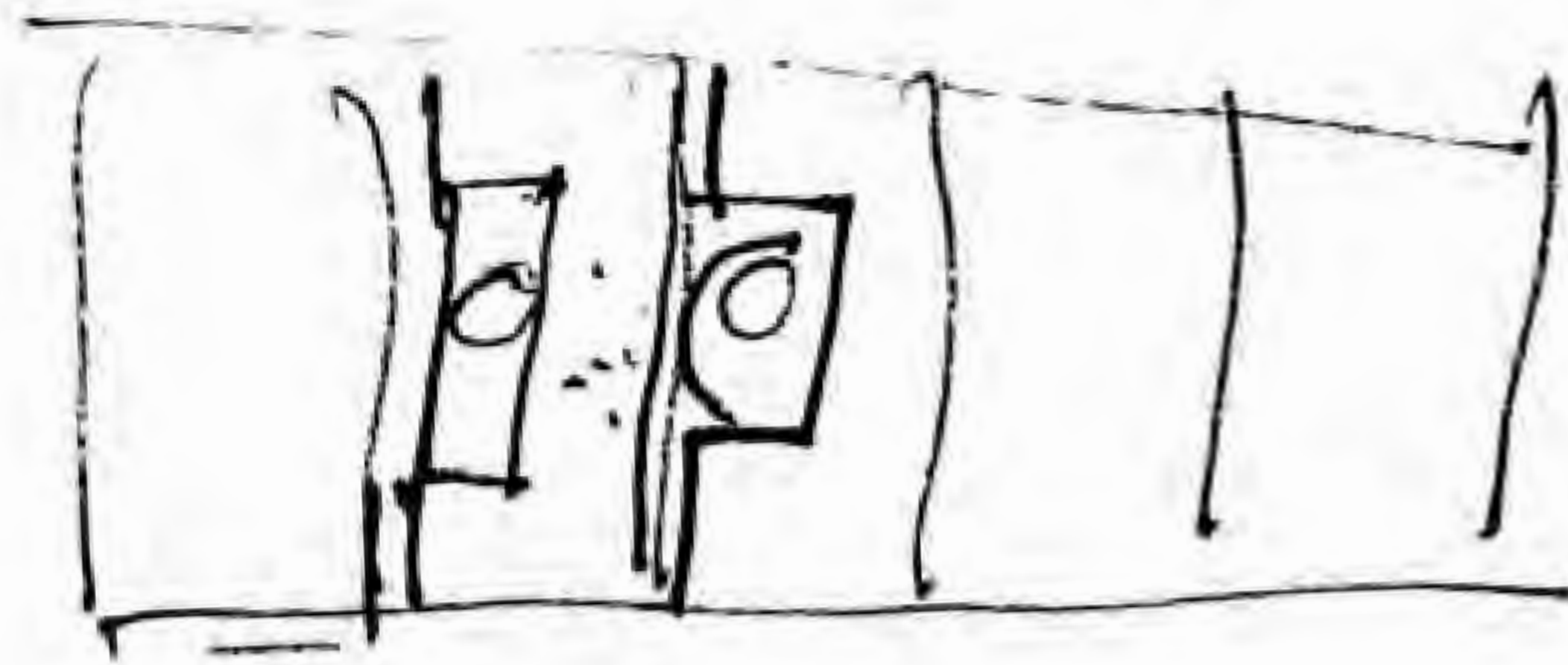
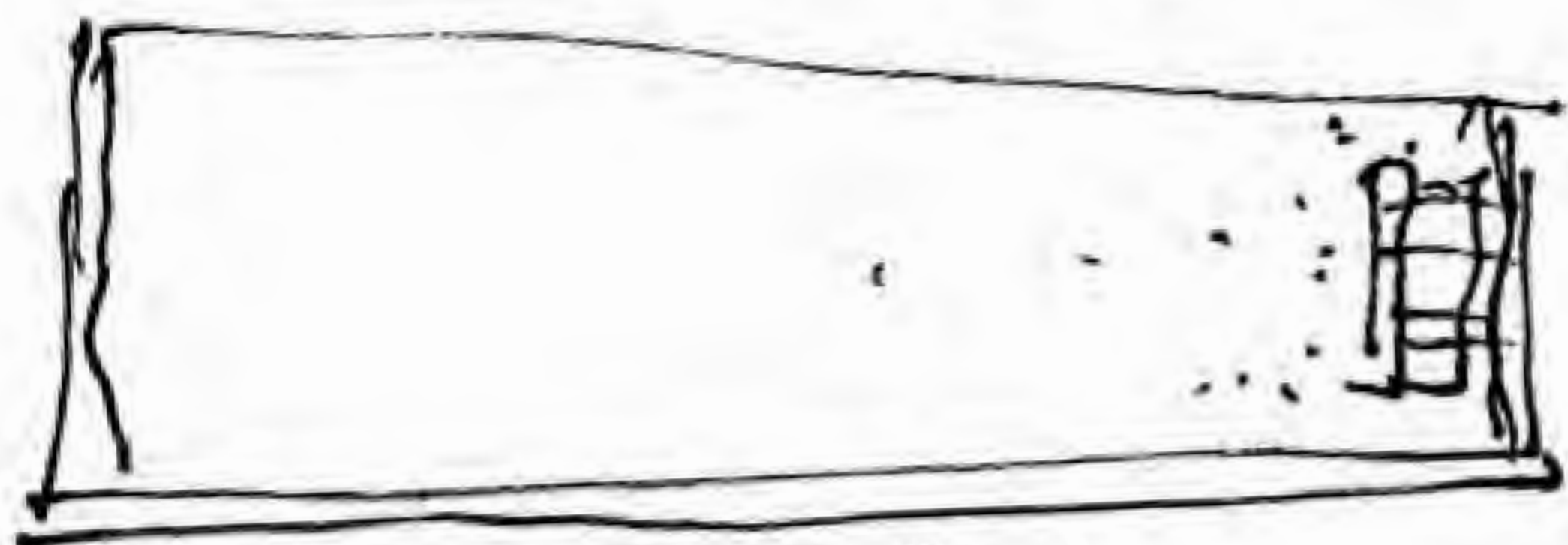

Lo más sencilla
lo más barata

• DORSET
MOORE

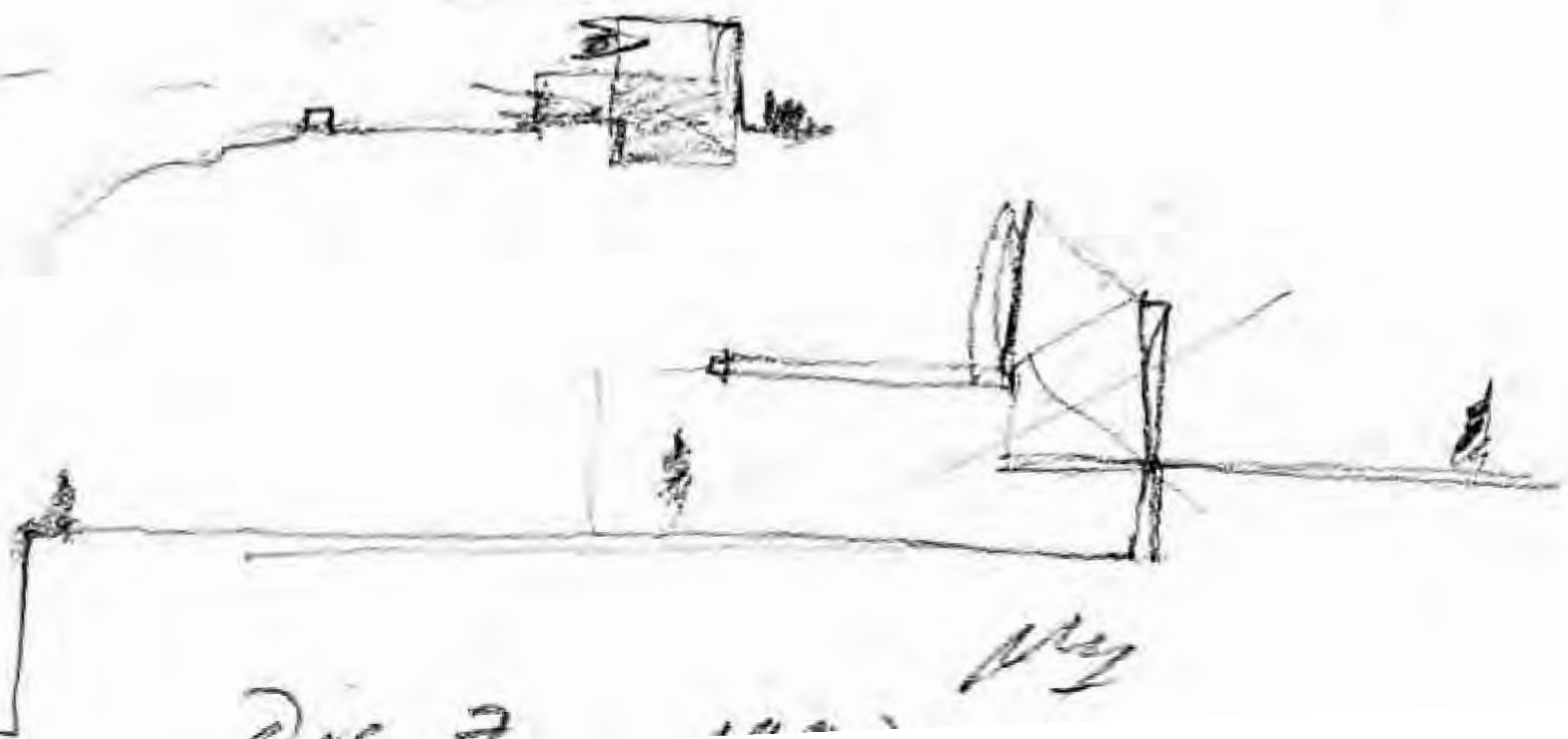
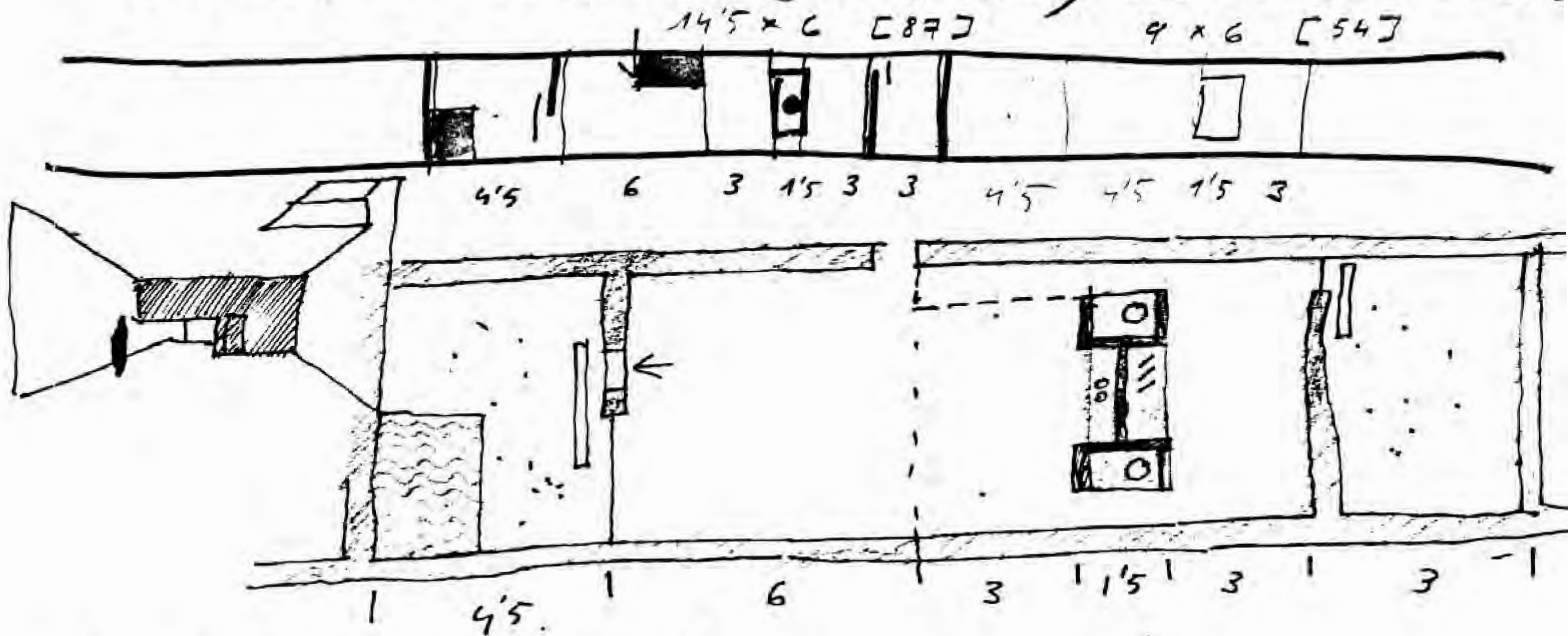

Fig 3

(HILLANA. CB HOUSE - (CB. WALLS) December 26. 1984. ^{97C}



> acabo de hablar con Juan.

(ofrecen 2000² m². por chidana -> 12 M)

> la tapia completa.

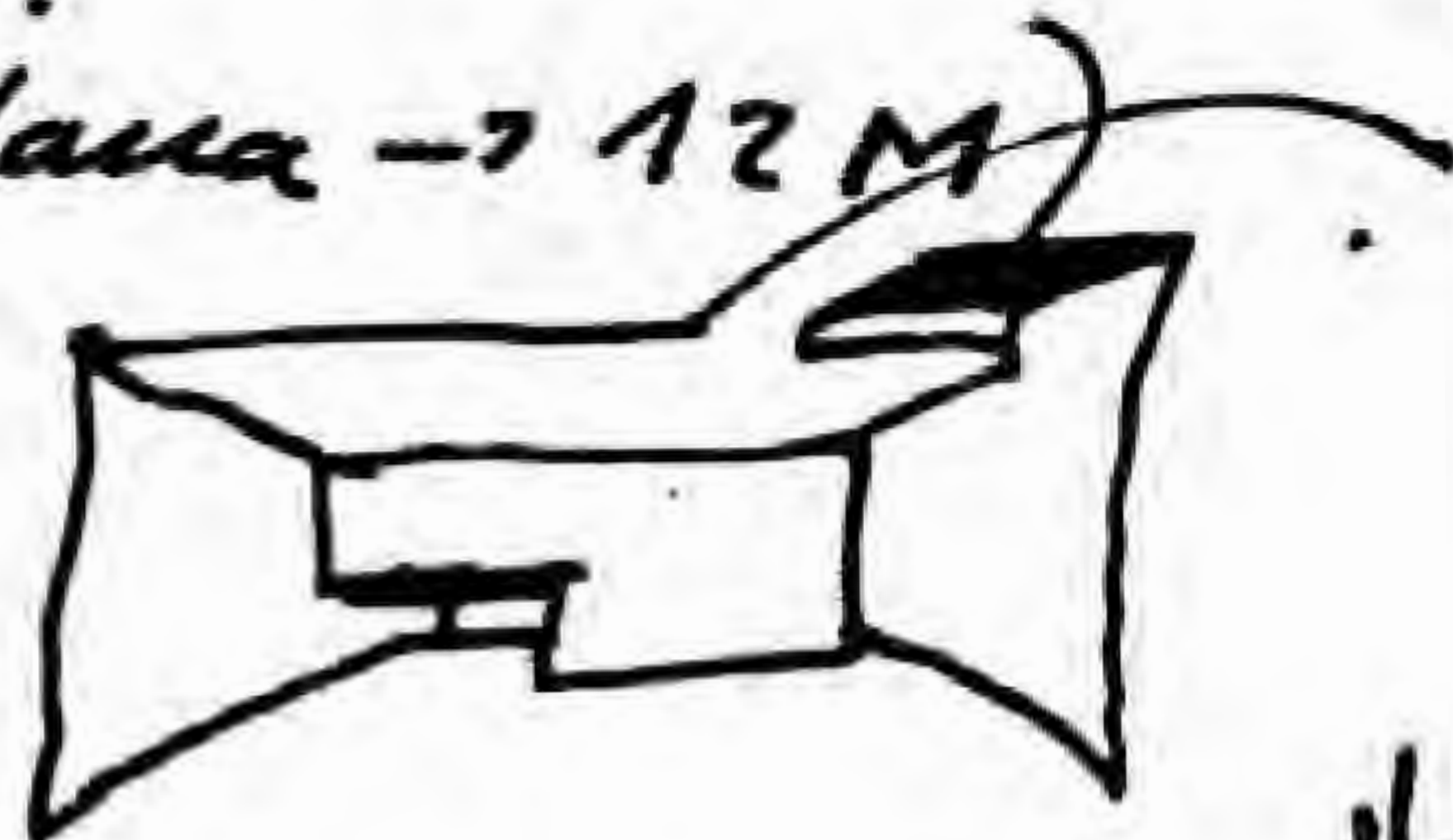
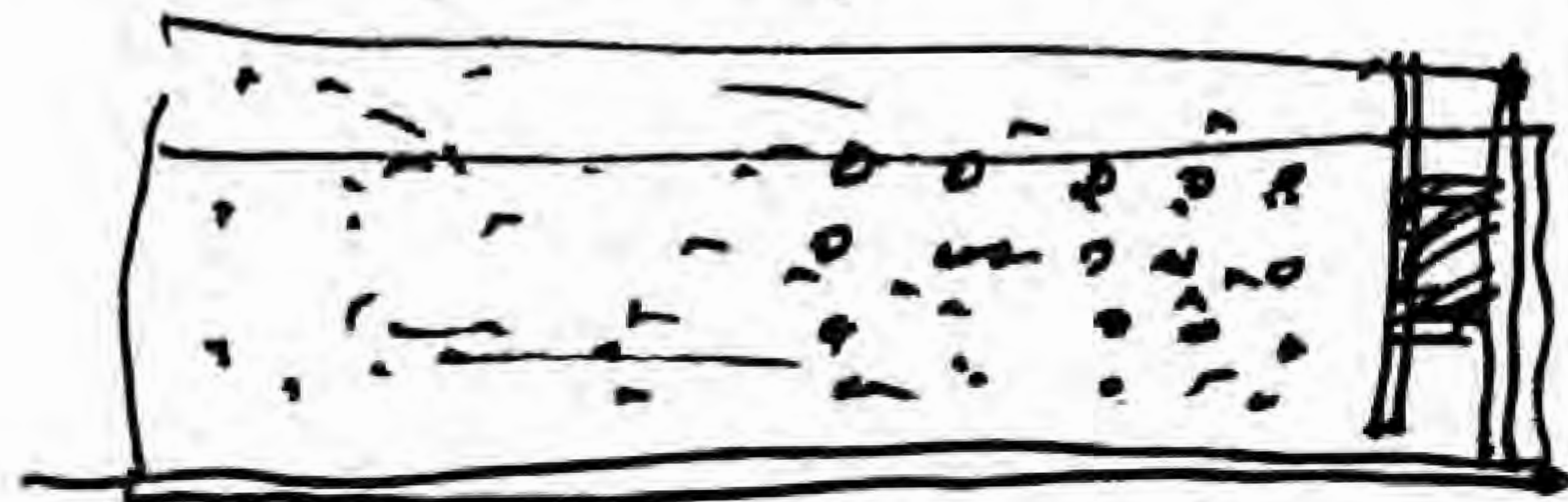

14'5
9
7'5
9

40

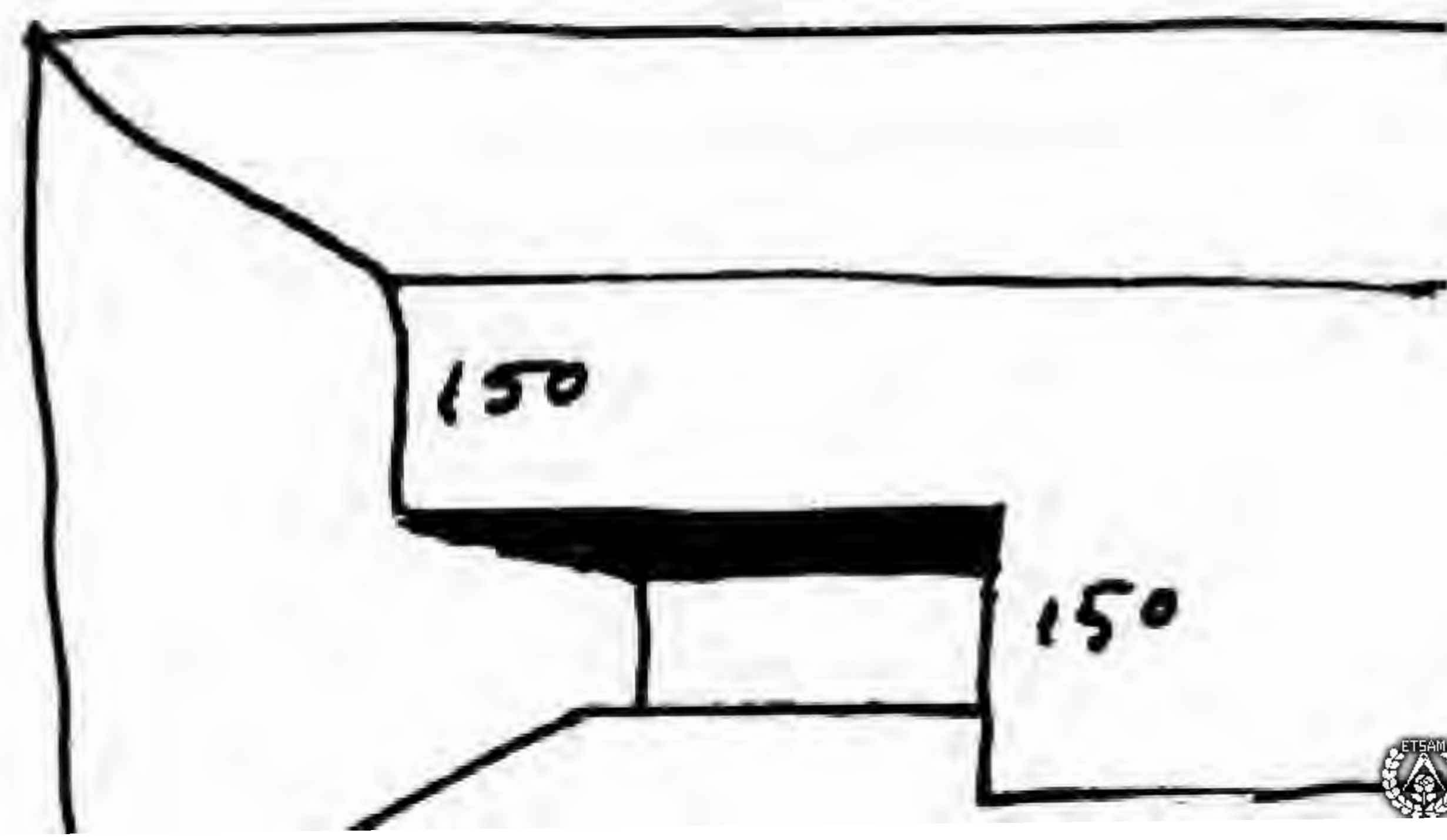
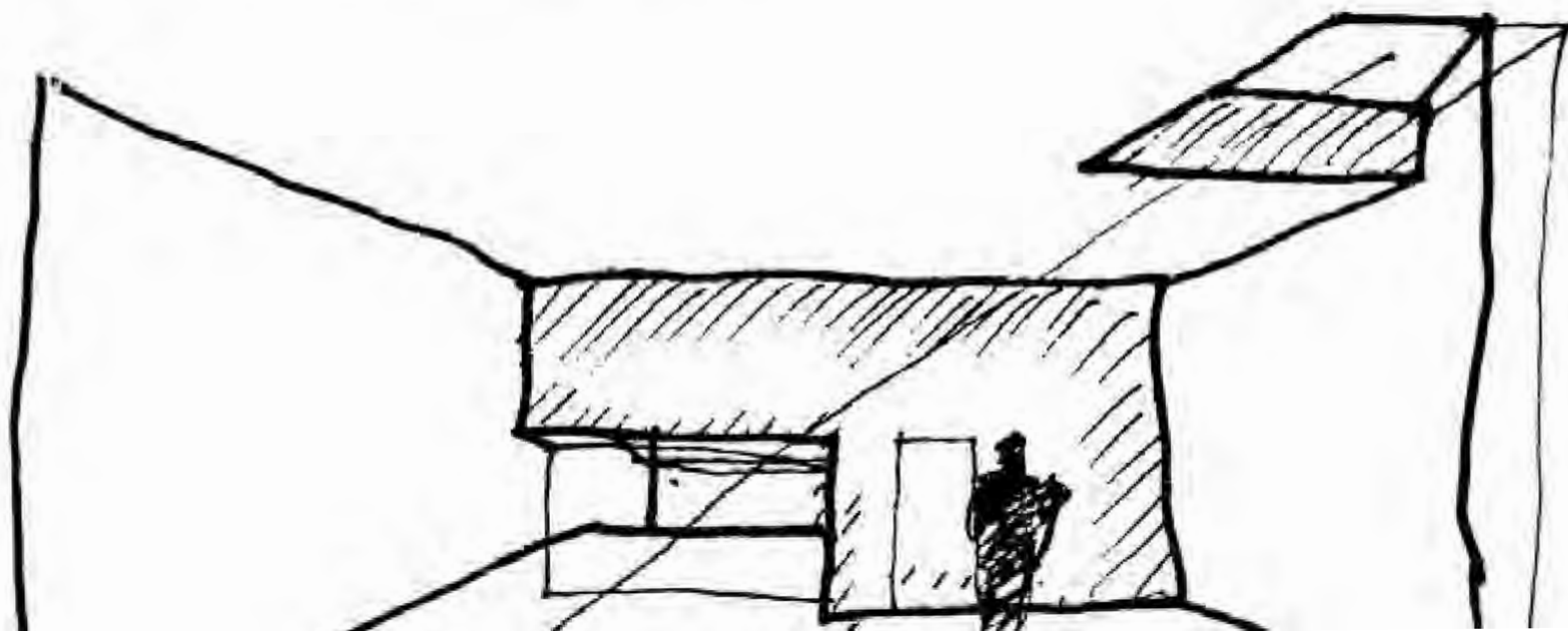
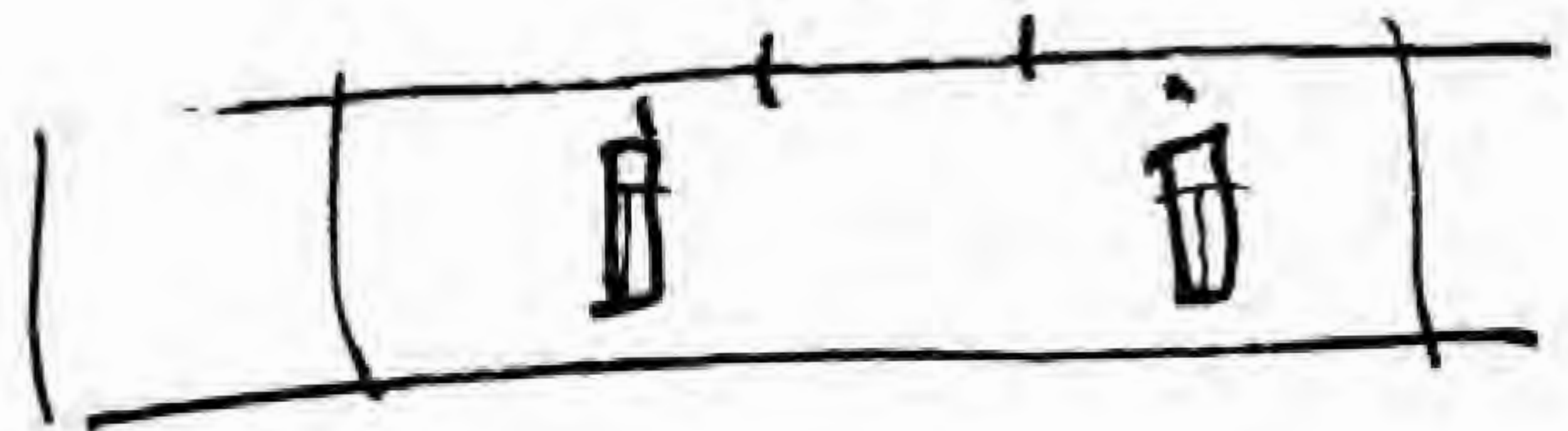

(10) Colunbario. (27 dic. 97).
antes. (10:30)



60x70cm.

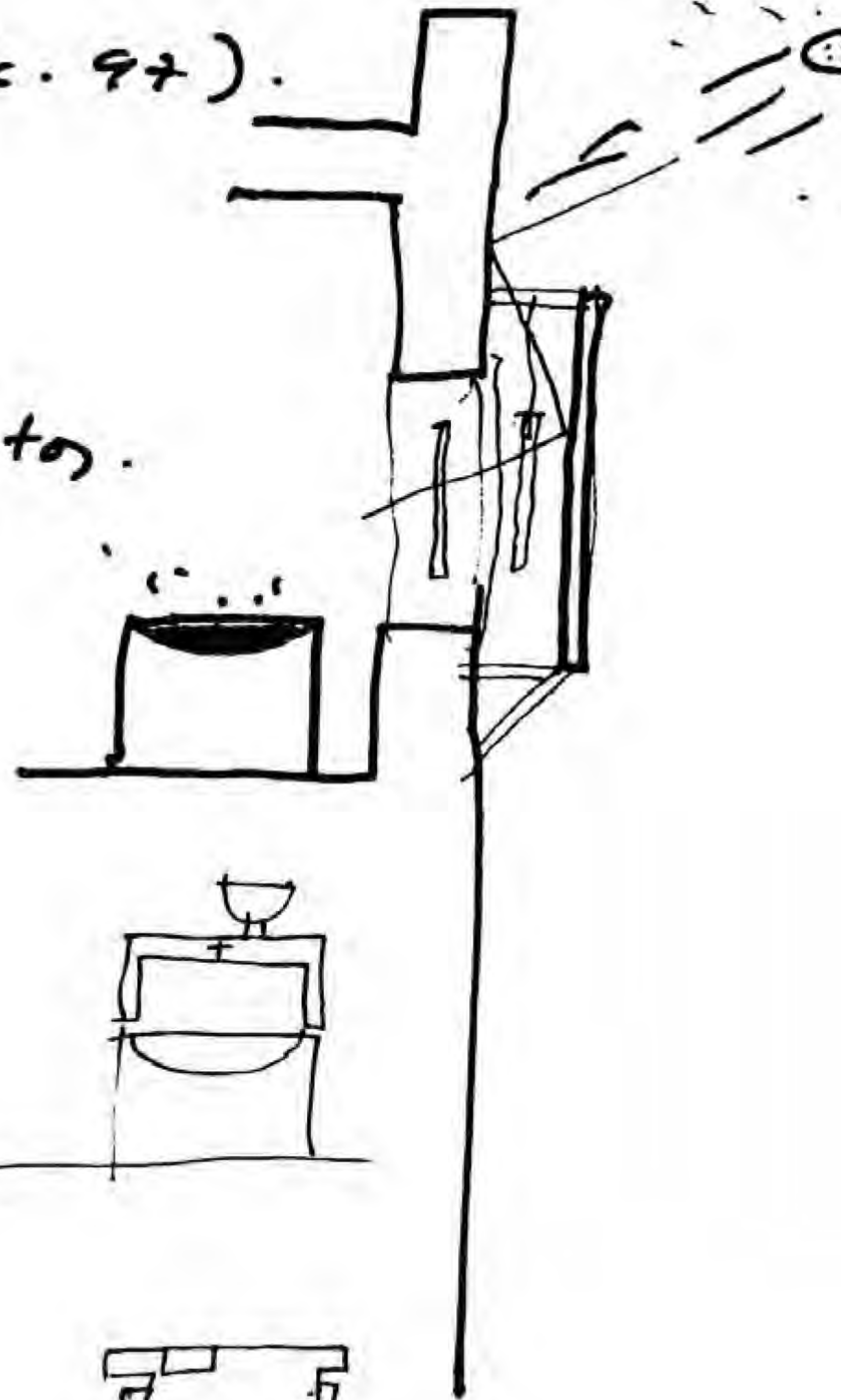

220

400

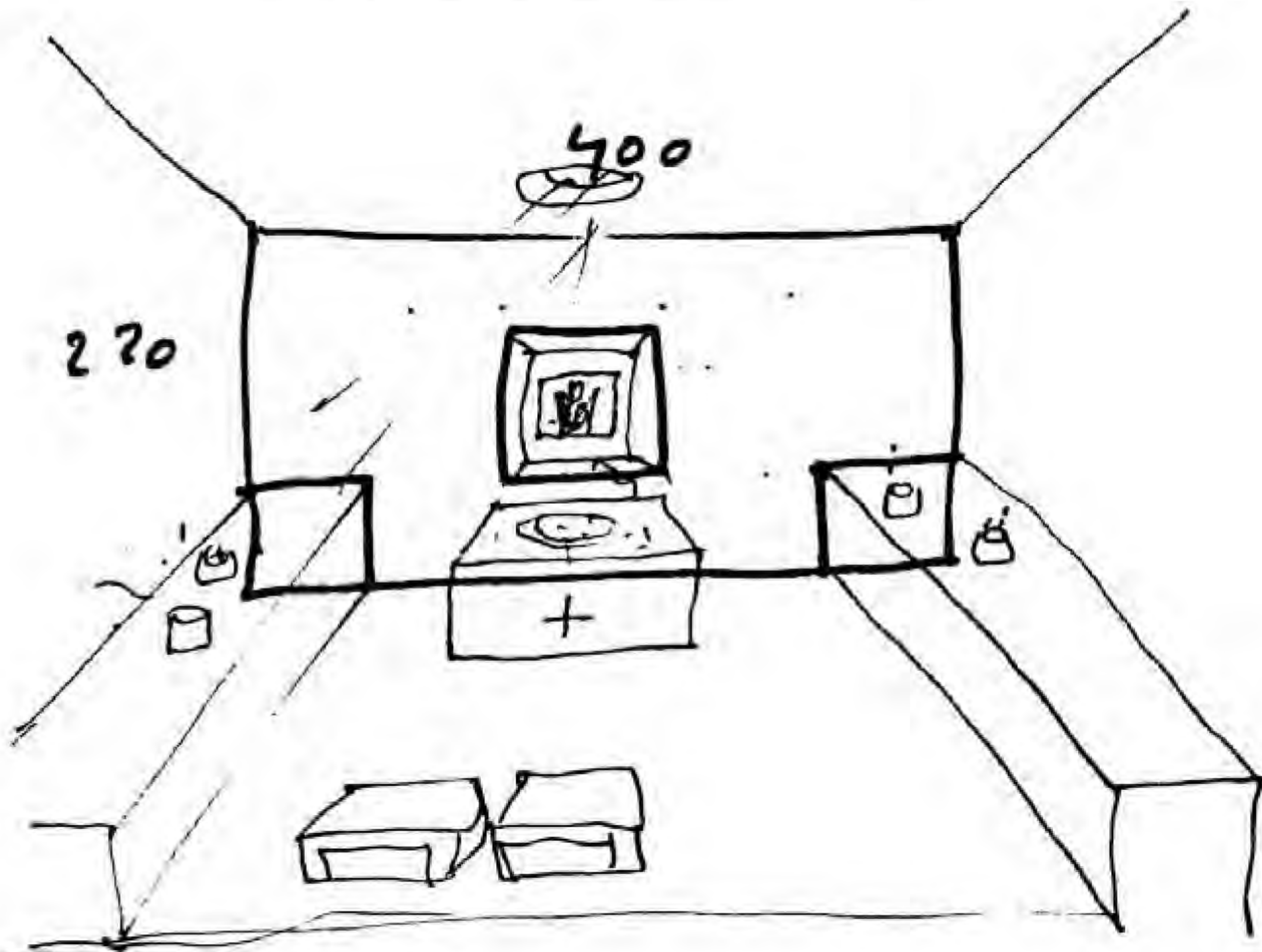

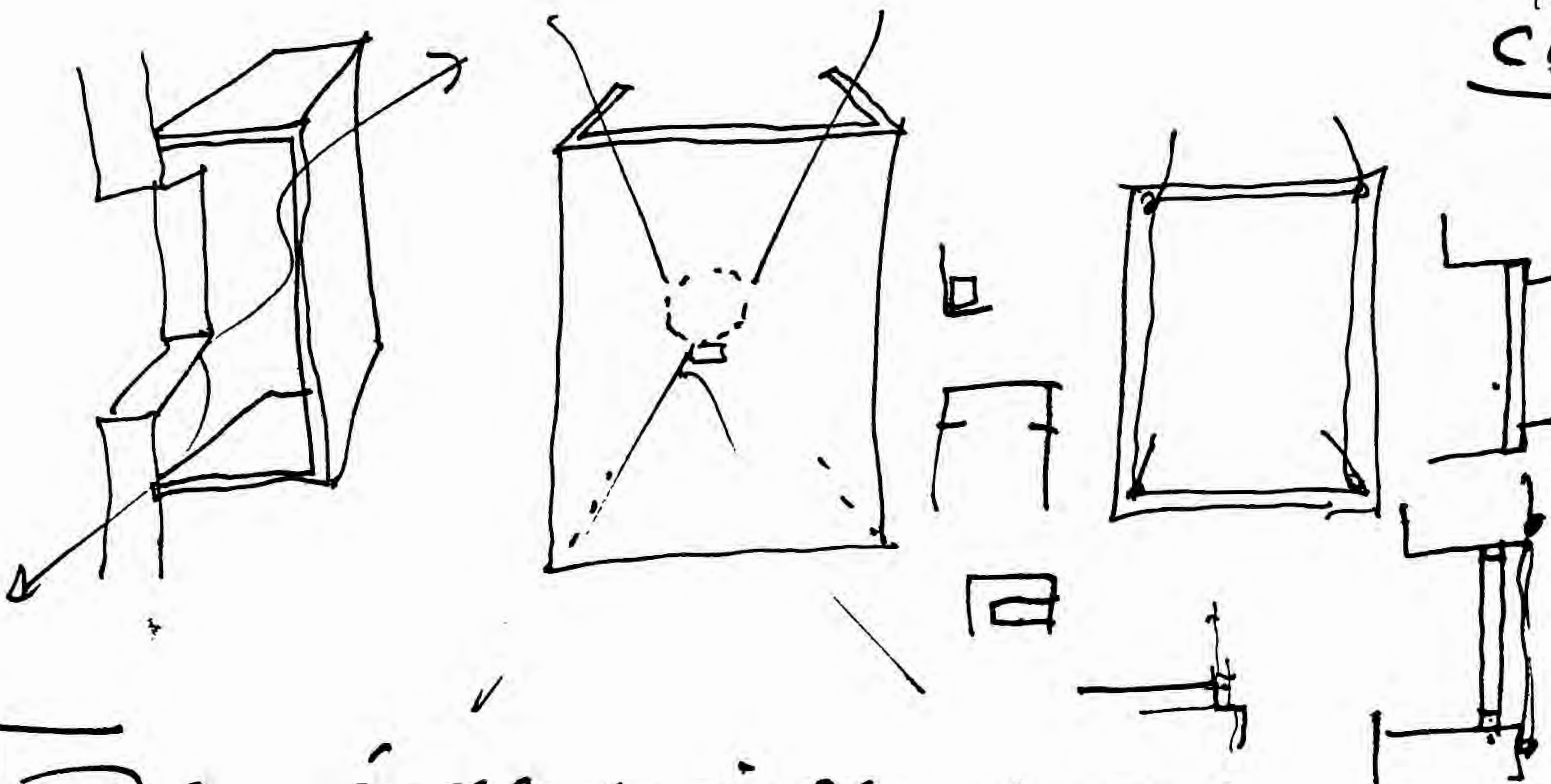

Después de la visita de este

~~various~~

December 27
1997.

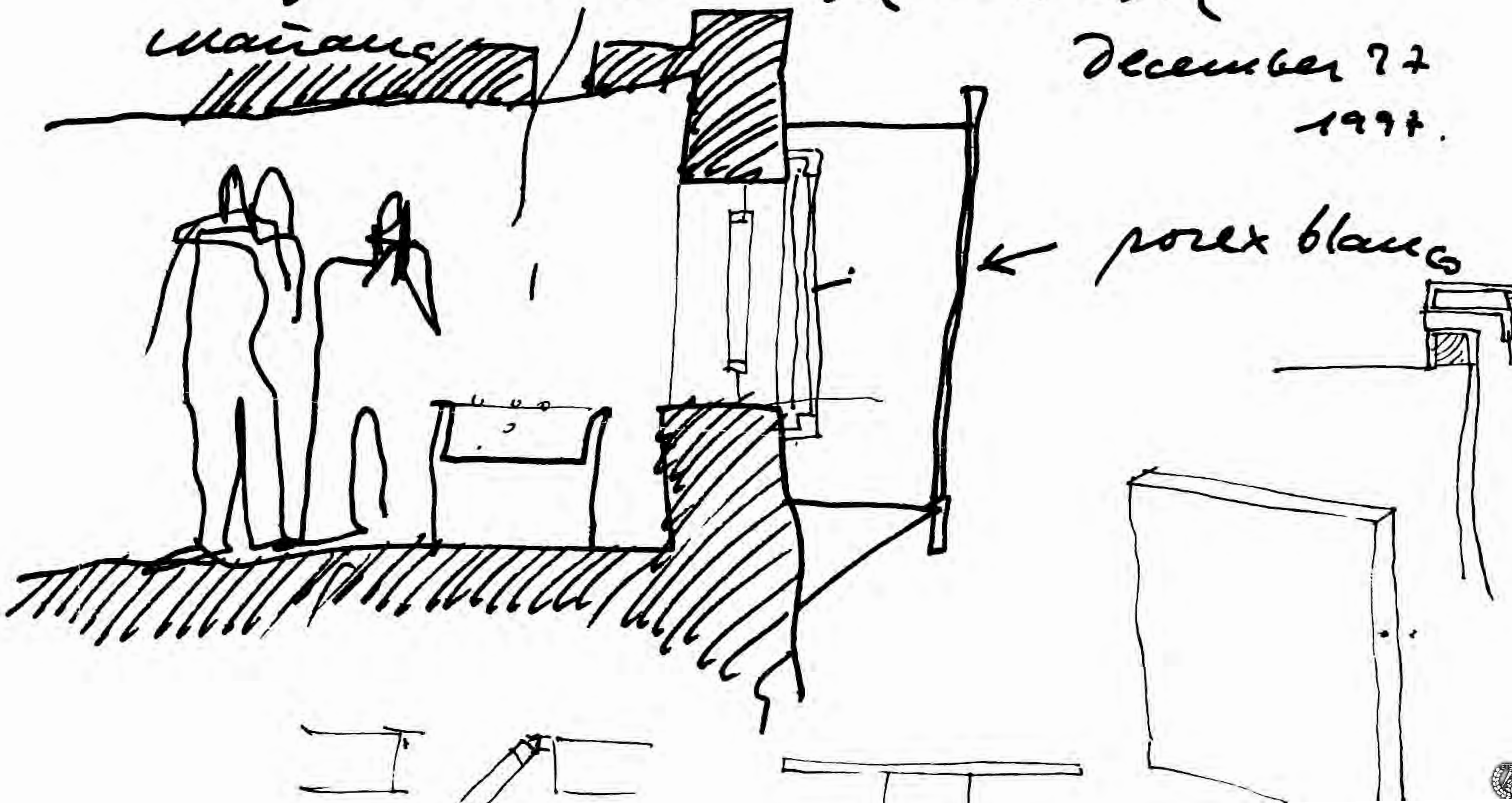

← porex blanc

MAO-VICALVARO
Dec. 10 1997.

maia Pius
c/ Sacrificio 18.

12.20.

Tien cercanias vicálvaro (des. de St. Eusebio)
Autobus 4/100. (2ª parada)

Solar c/ Sacrificio des. S. Cipriano.

9 x 13 (solar

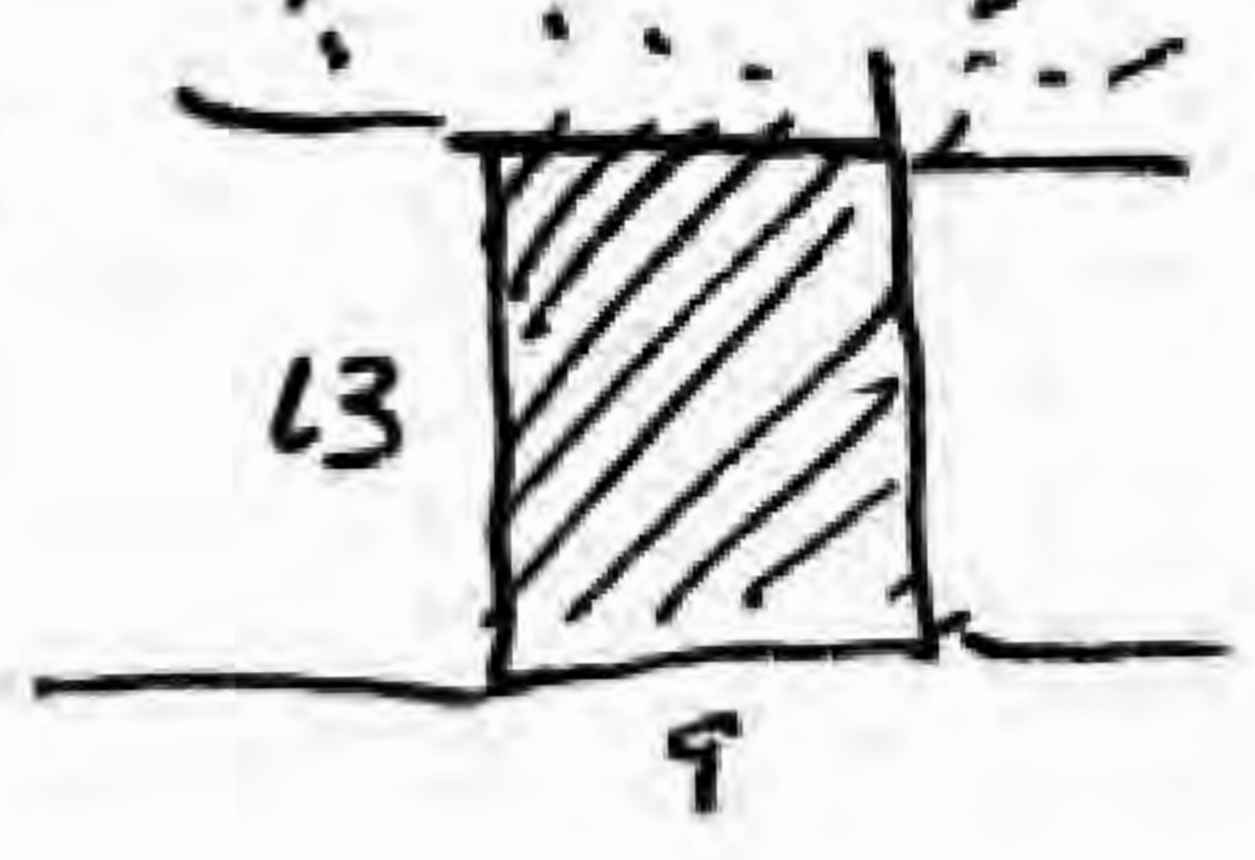

117 m² planta.

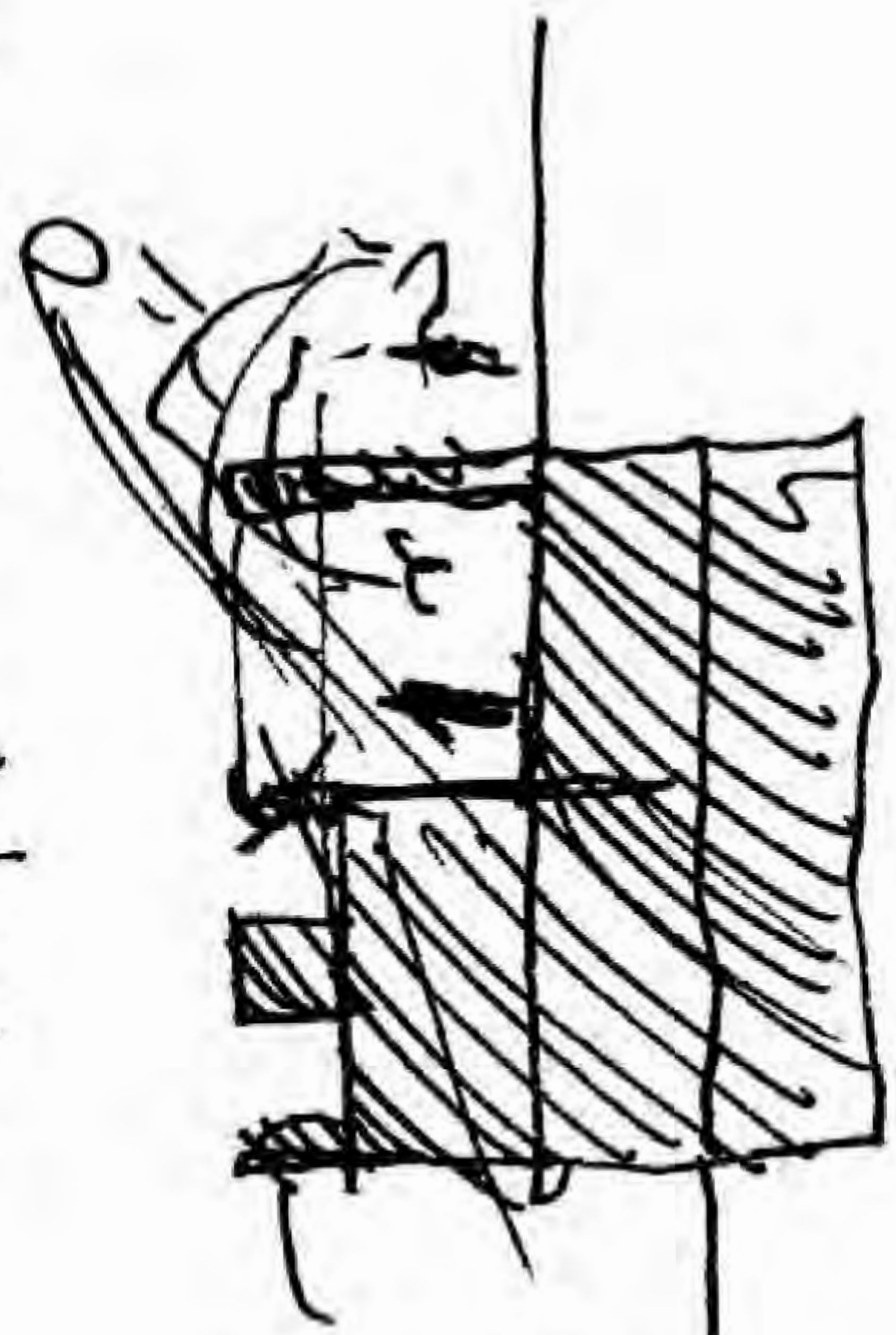
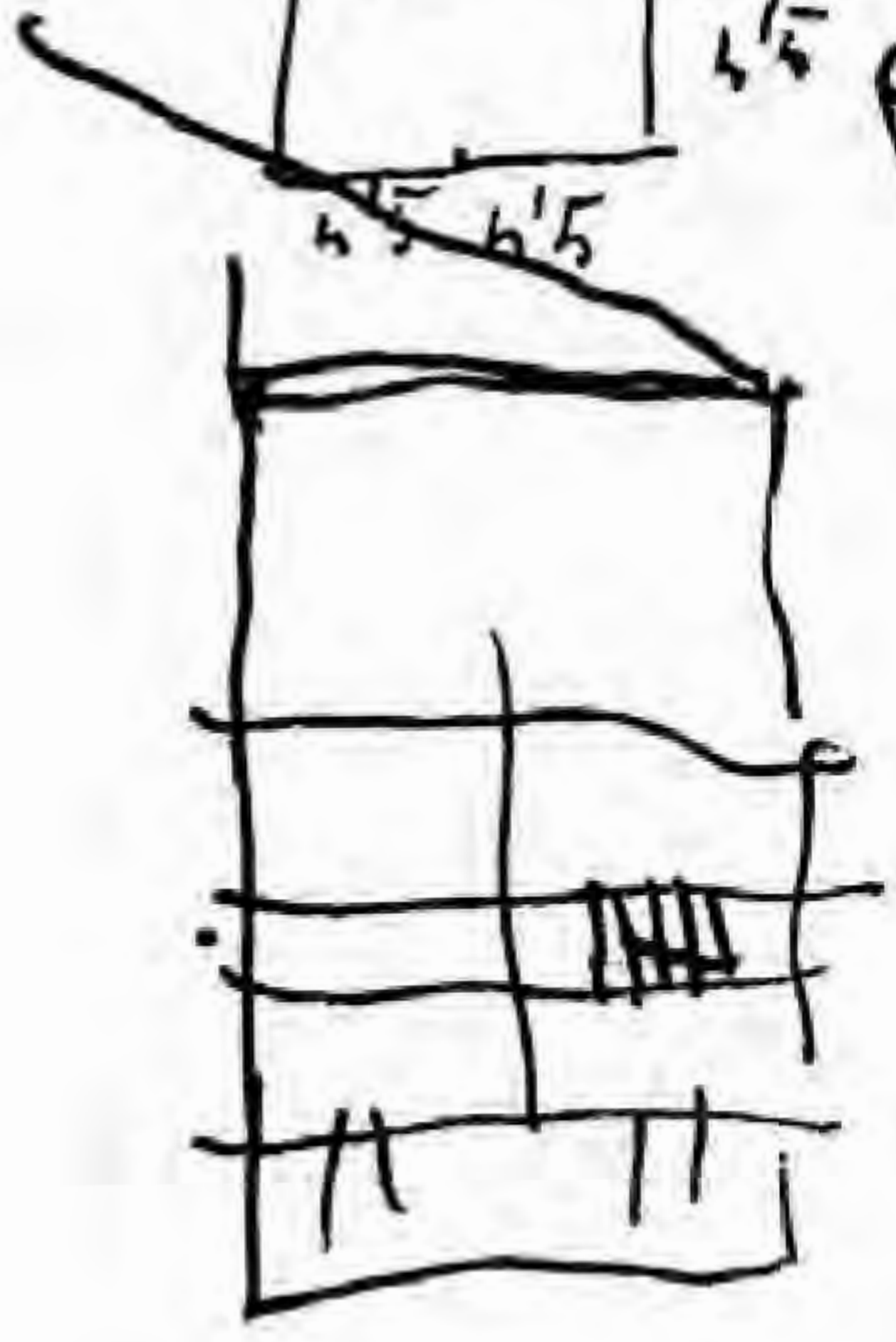
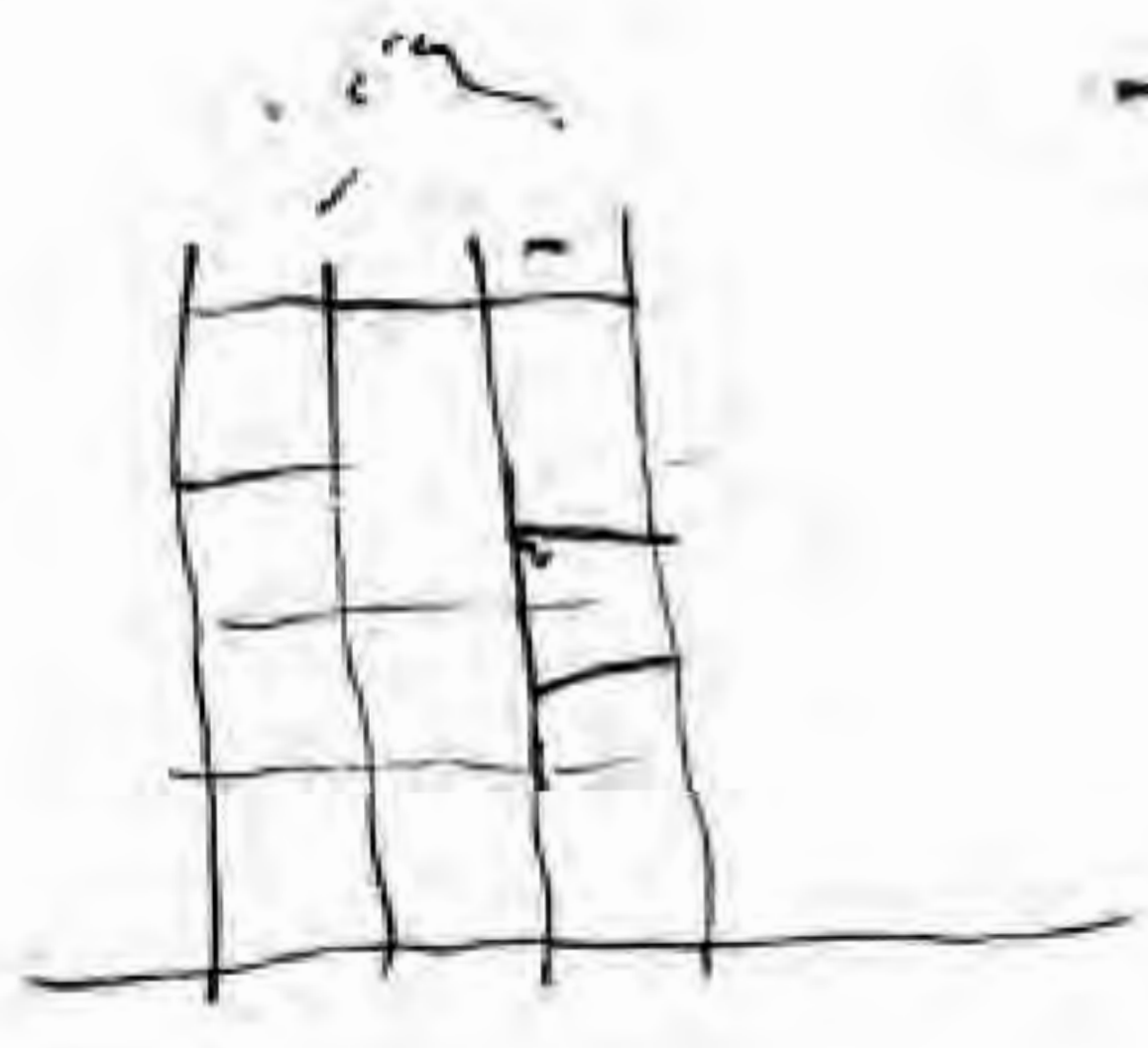
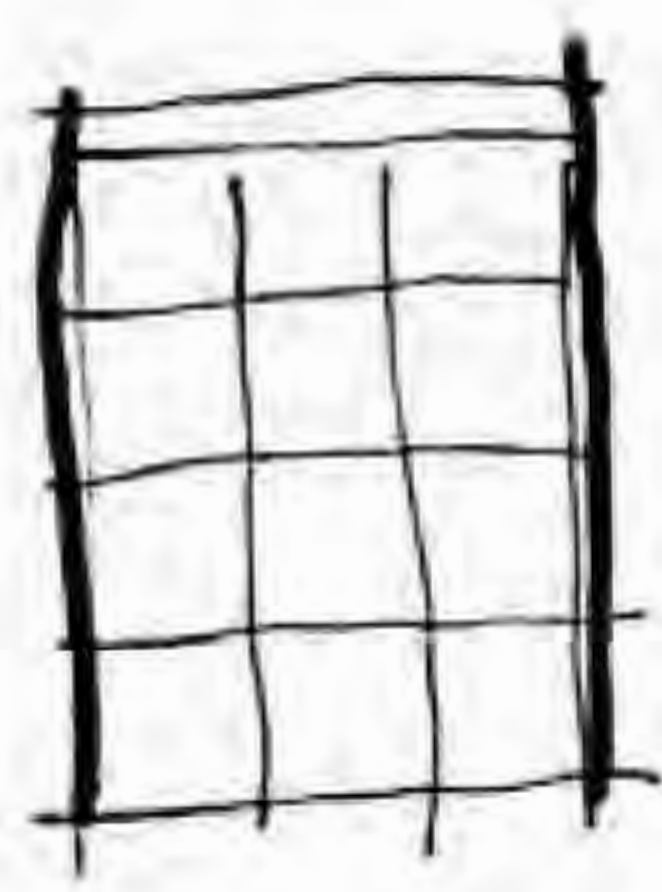

Preguntas.

- 1) libertad.
- 2) constructor (buscan)
- 3) org. municipal
- 4) ordenanza
- 5) altura
- 6) i arrotea?
- 7) i sótano? i garaje?

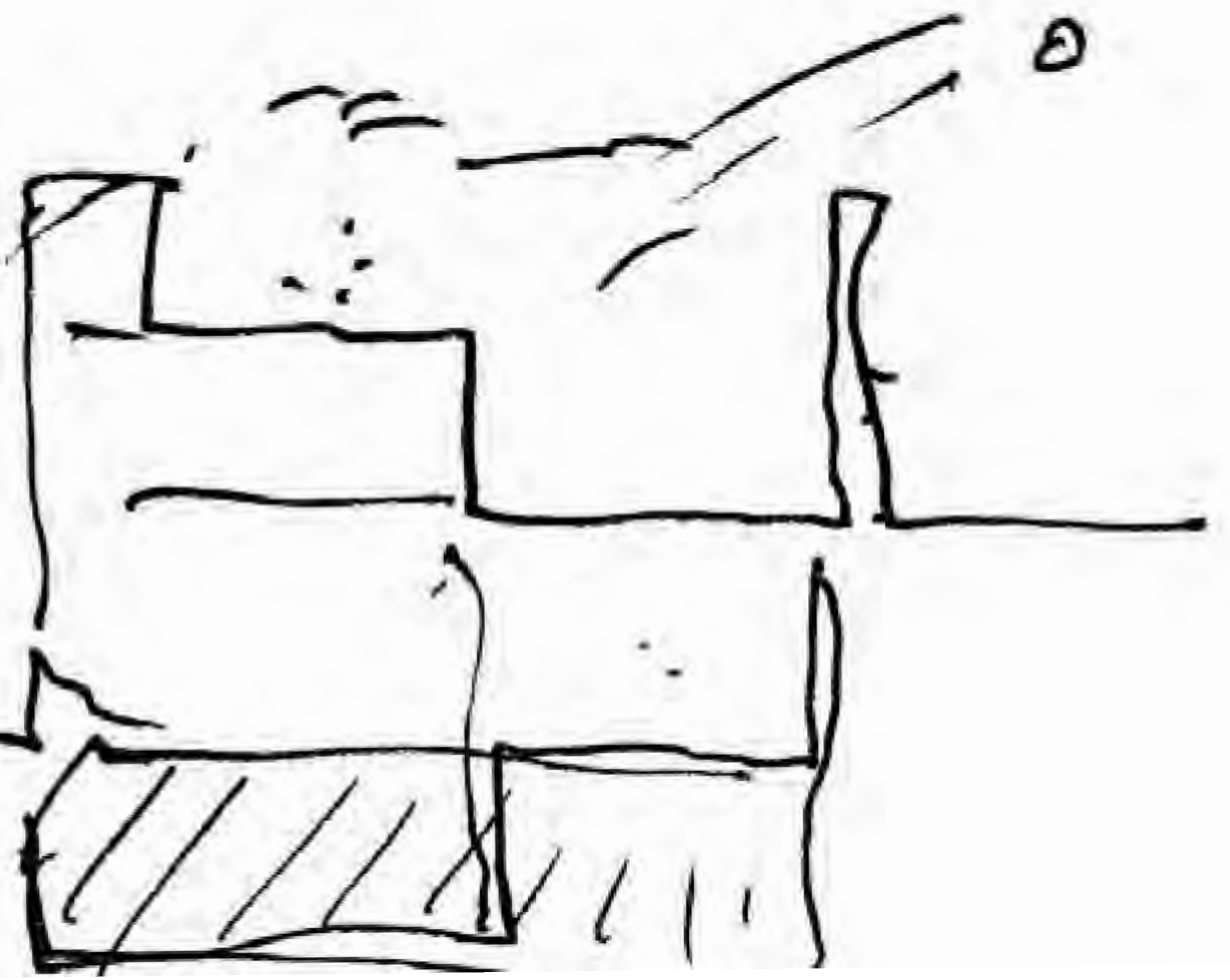

Casa Pius. Alcorn.

María Consuelo

Daniel ~

Domingo |

Javier. ~

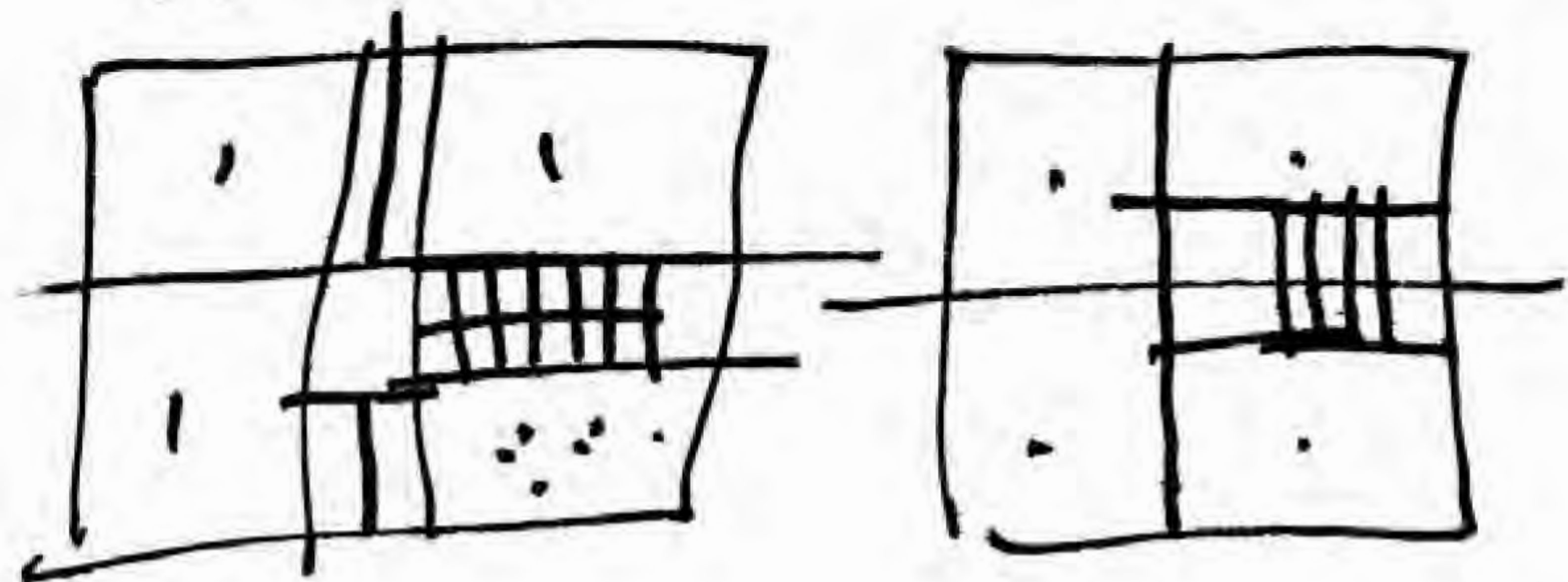
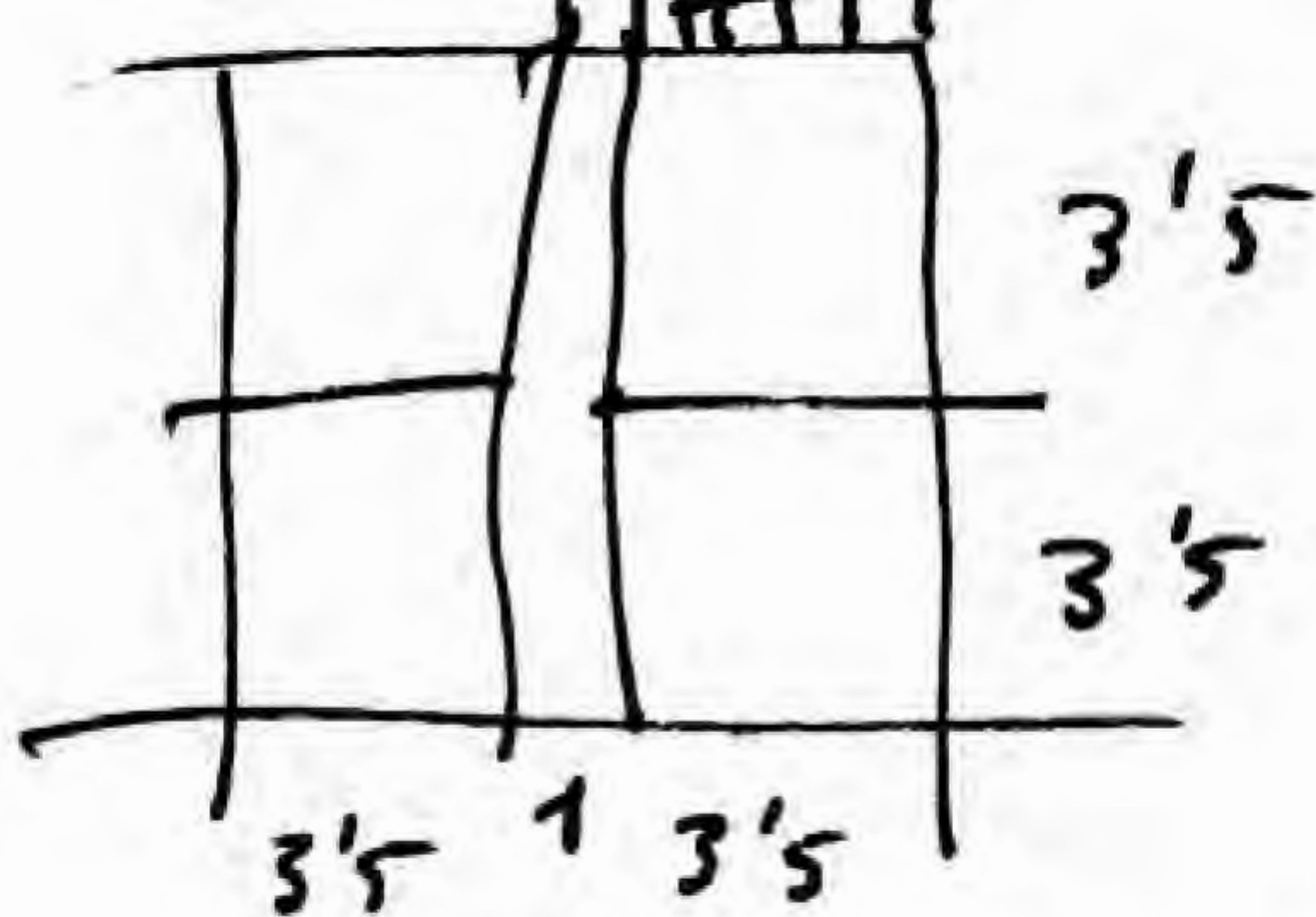

2

630 col.

545.

MAD → ALMERÍA
 December. 12. 1997
 Friday

viaje para firmar el contrato
 de la Plaza de la Catedral de
 Almería /

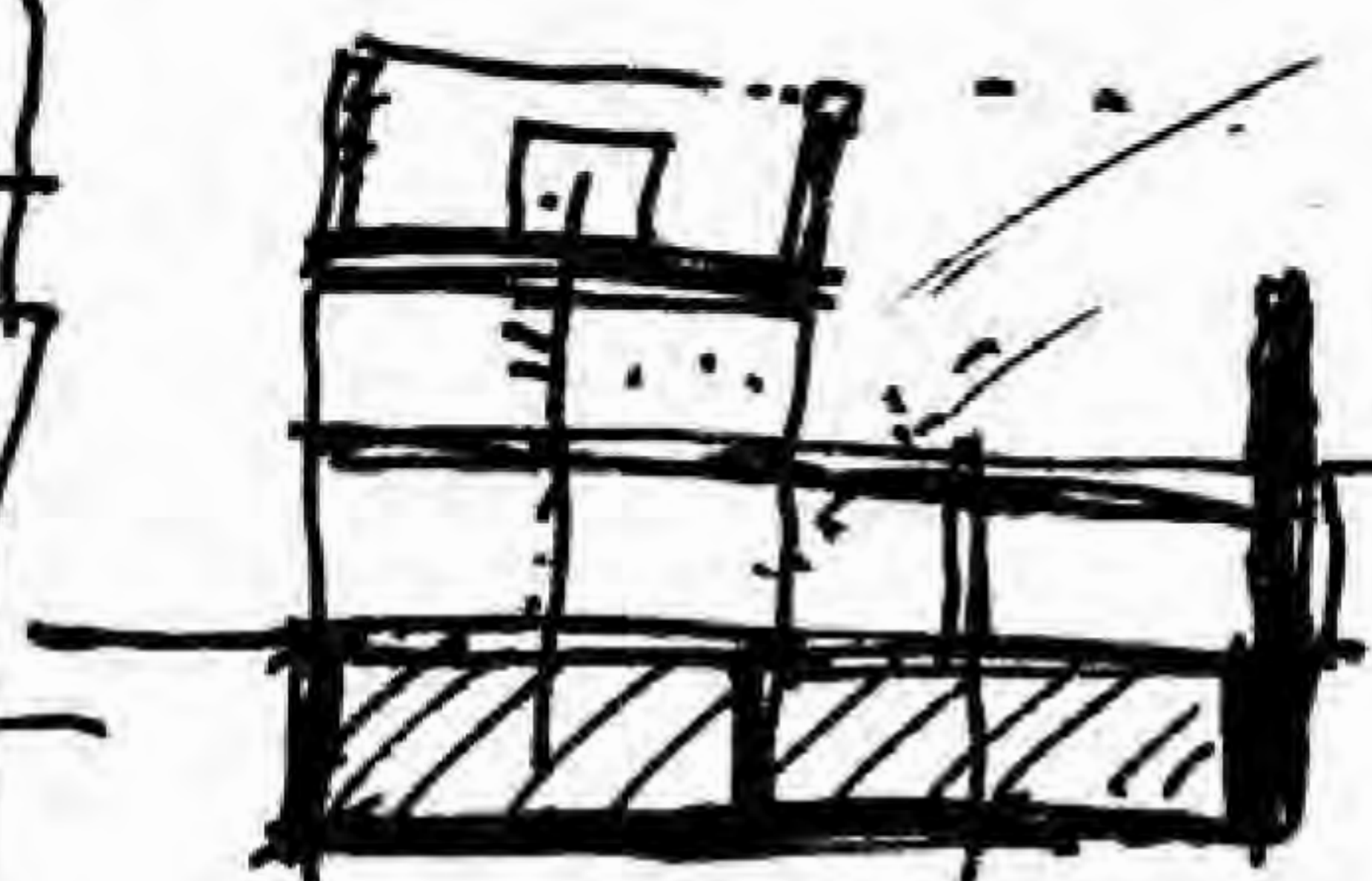
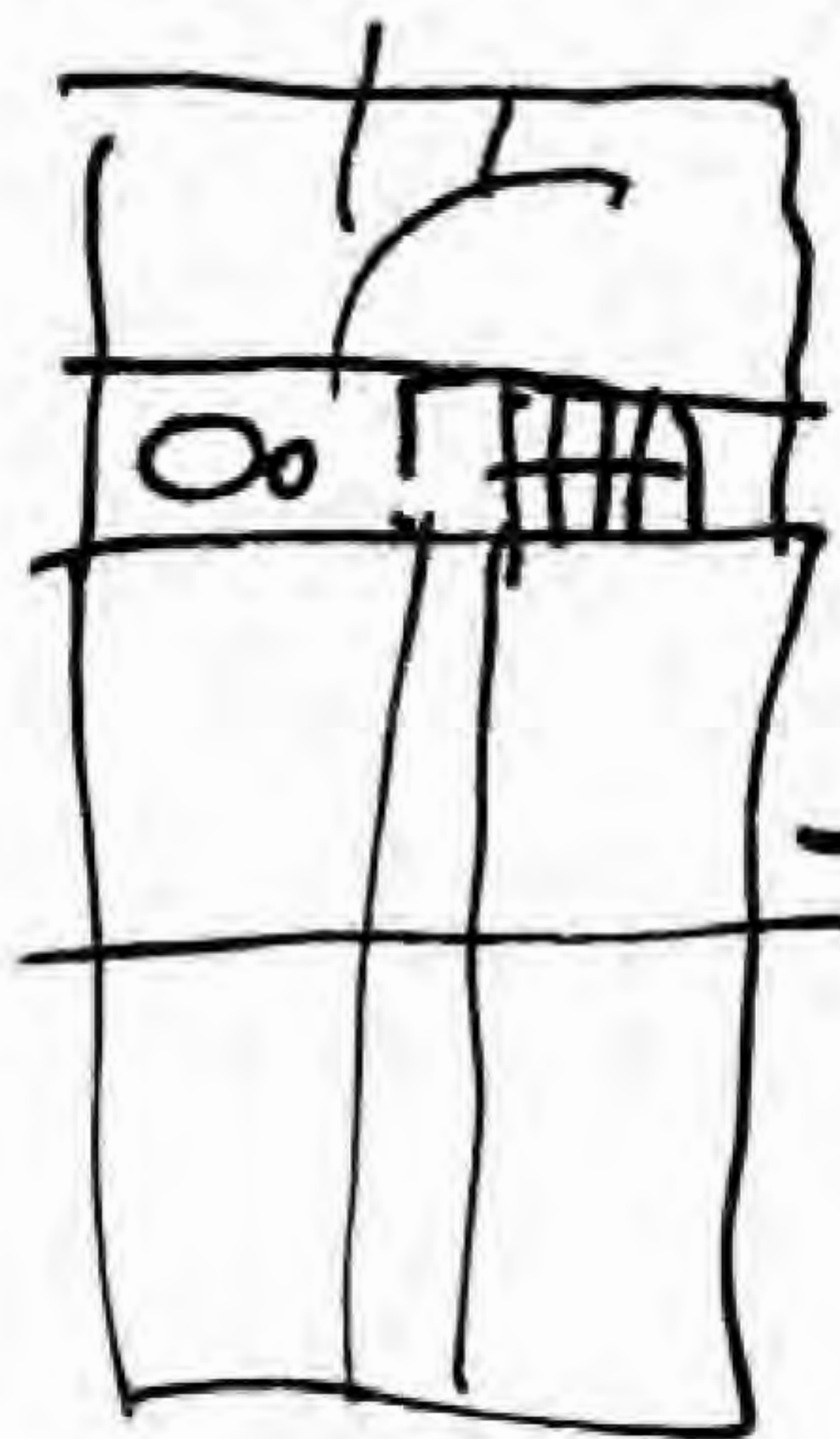
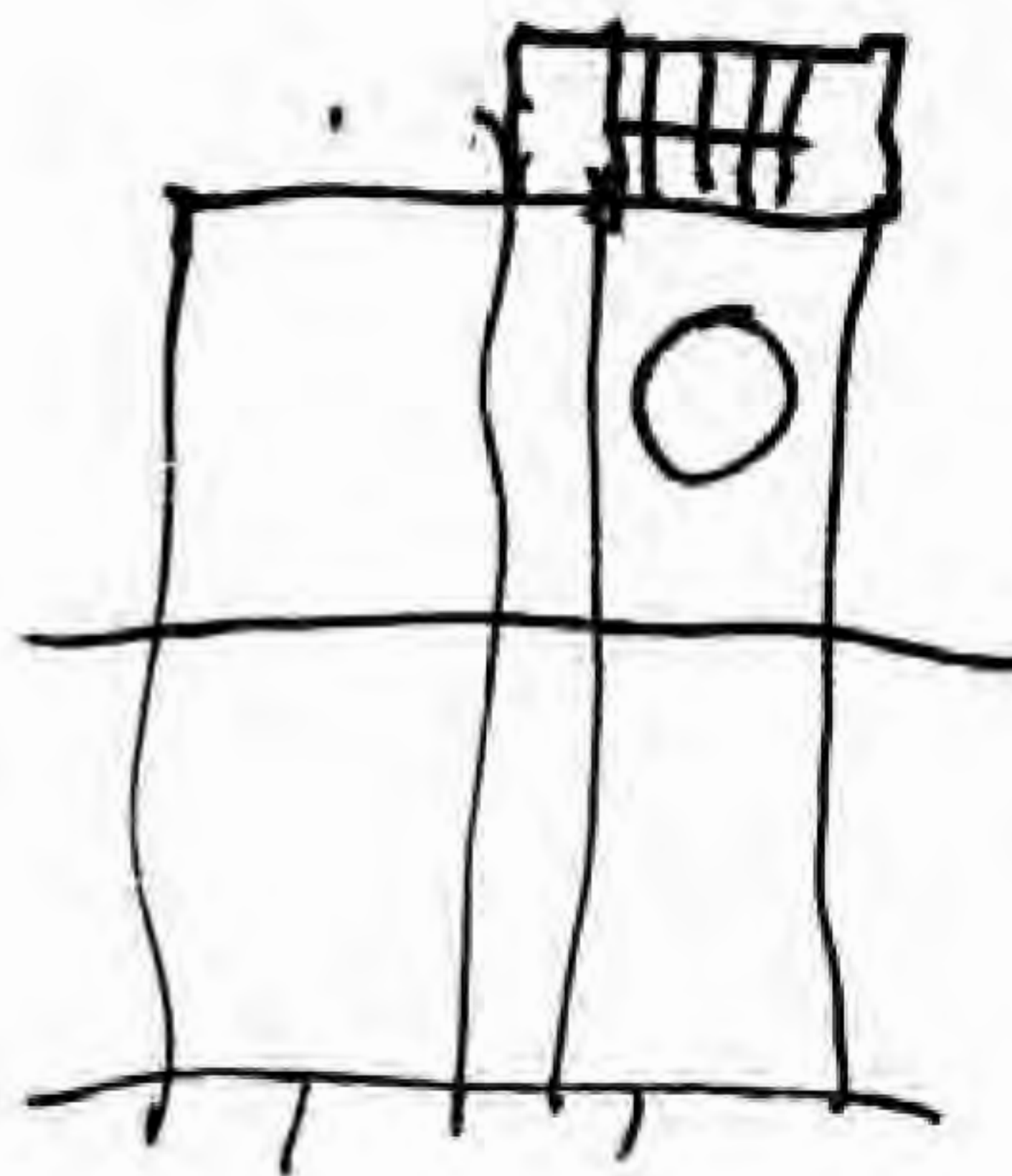
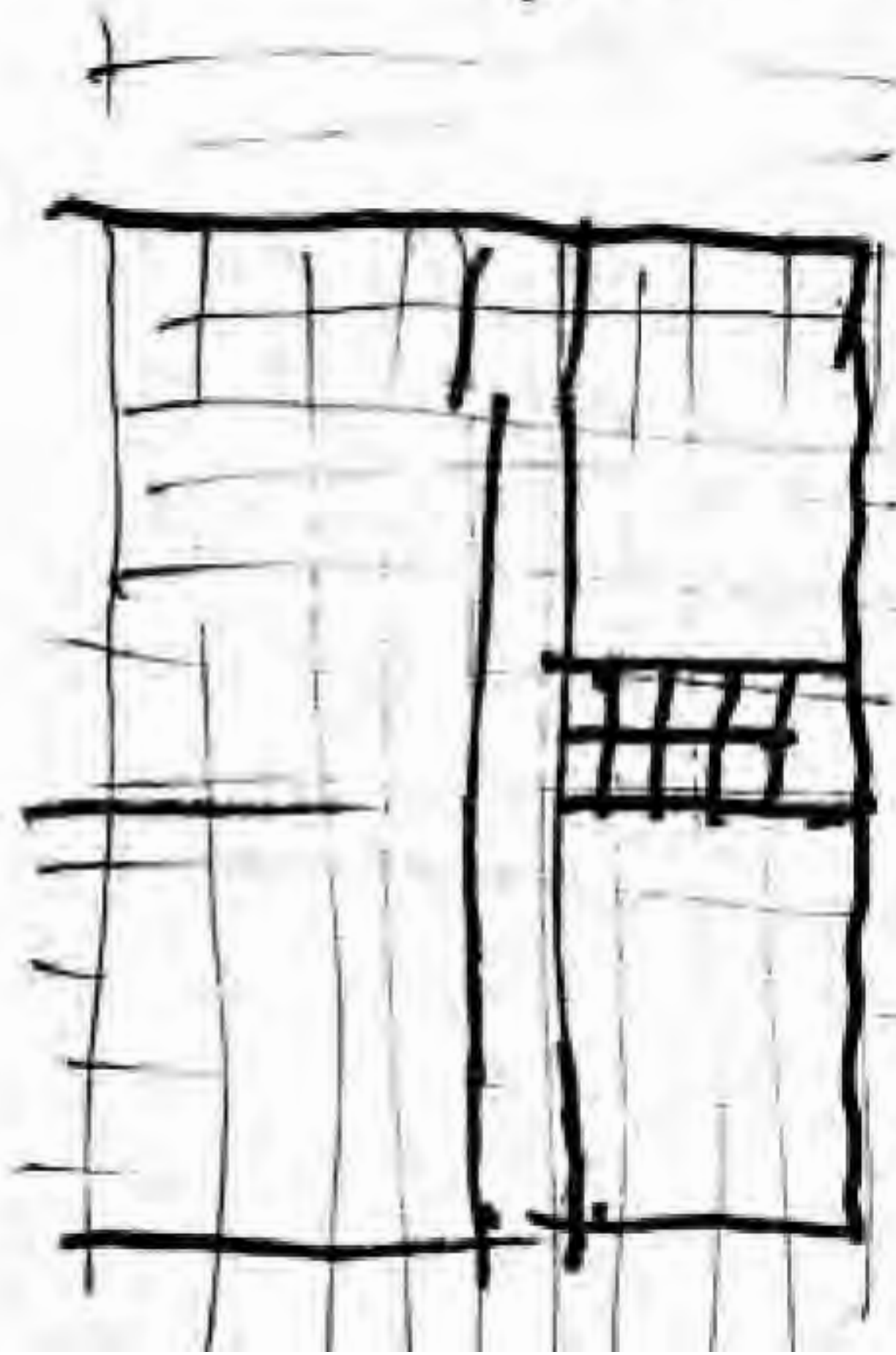

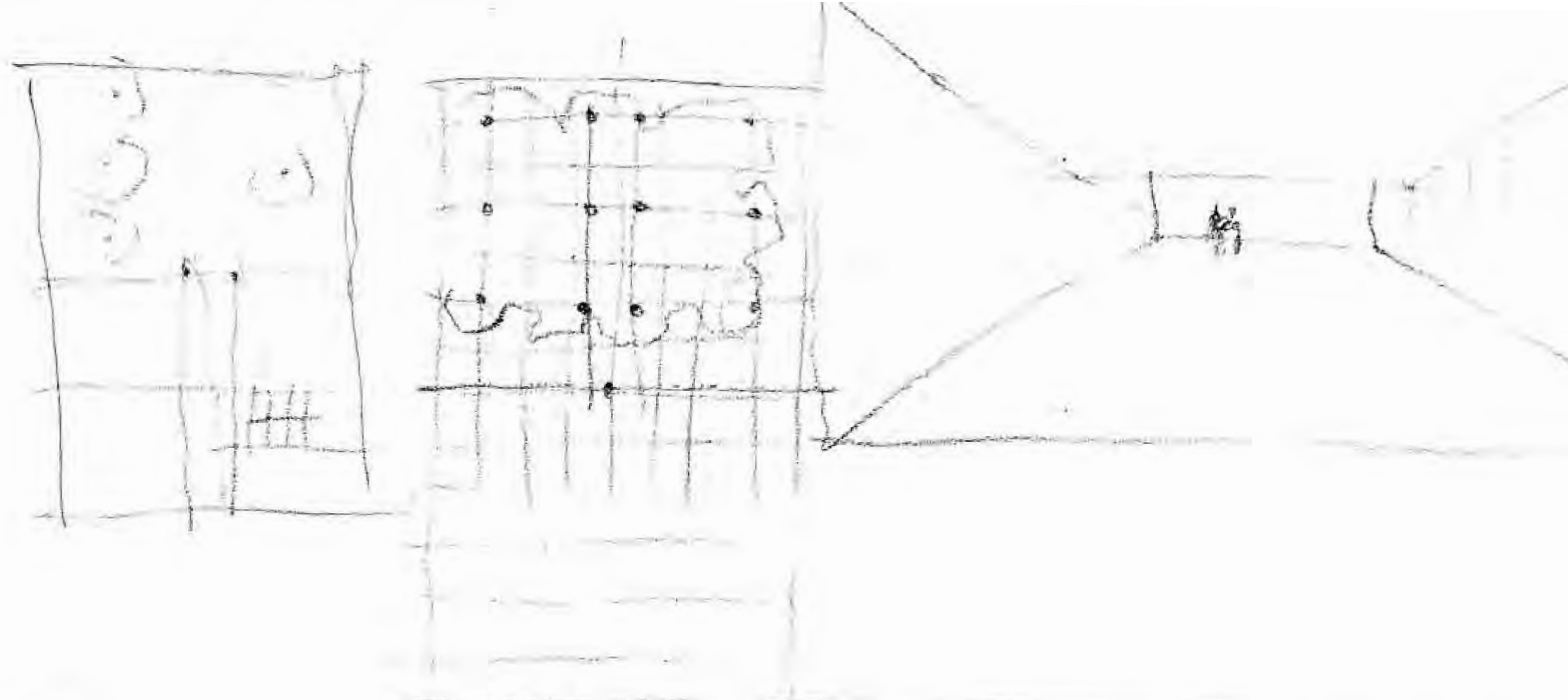

Navidad 97. [December 21. 1997] *

[> texto → para Casabella] — orden frab
 [> proy. para Camu. ...] — contexto

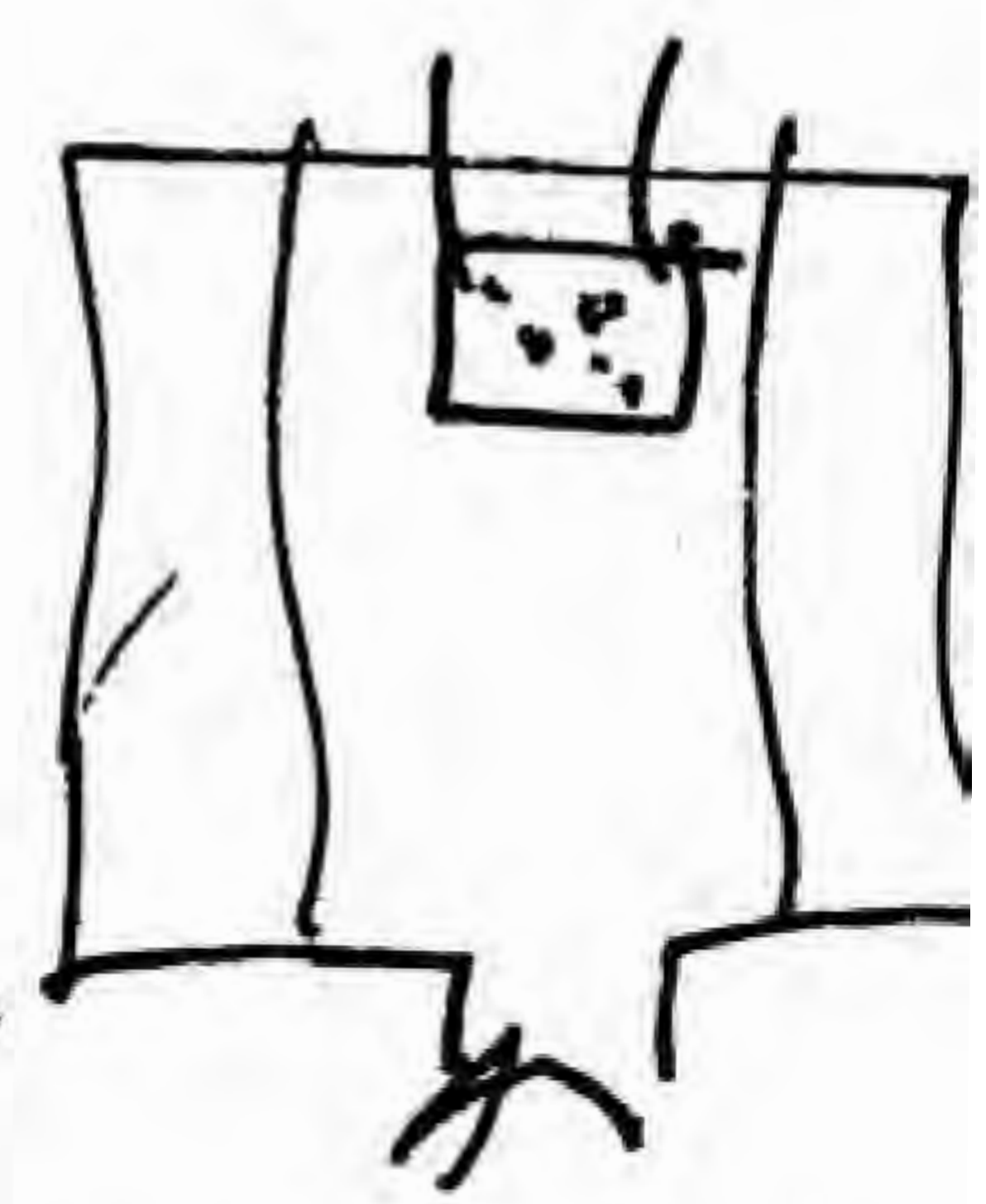
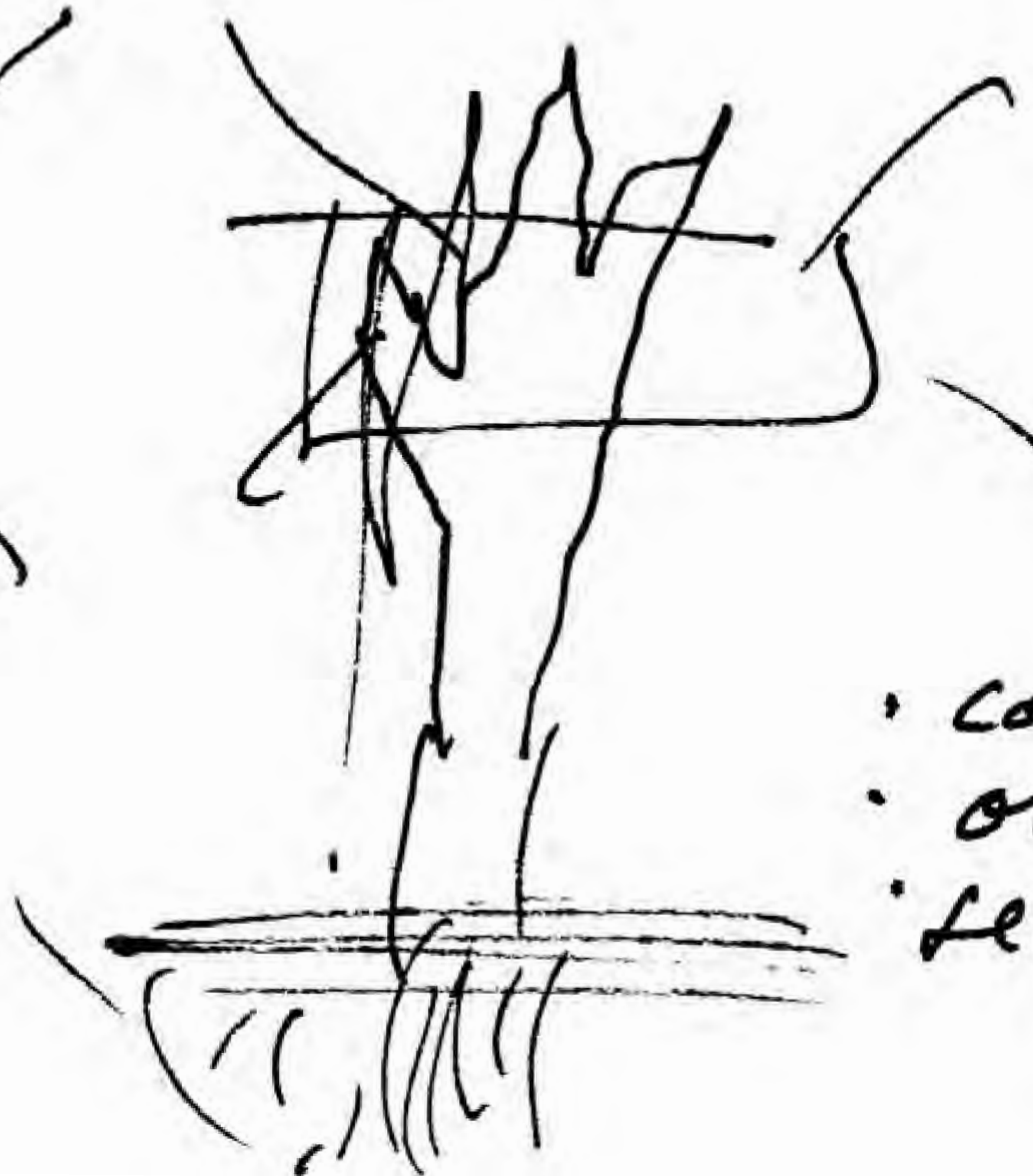

- contexto - euclasa
- orden. frid.
- secret garden.

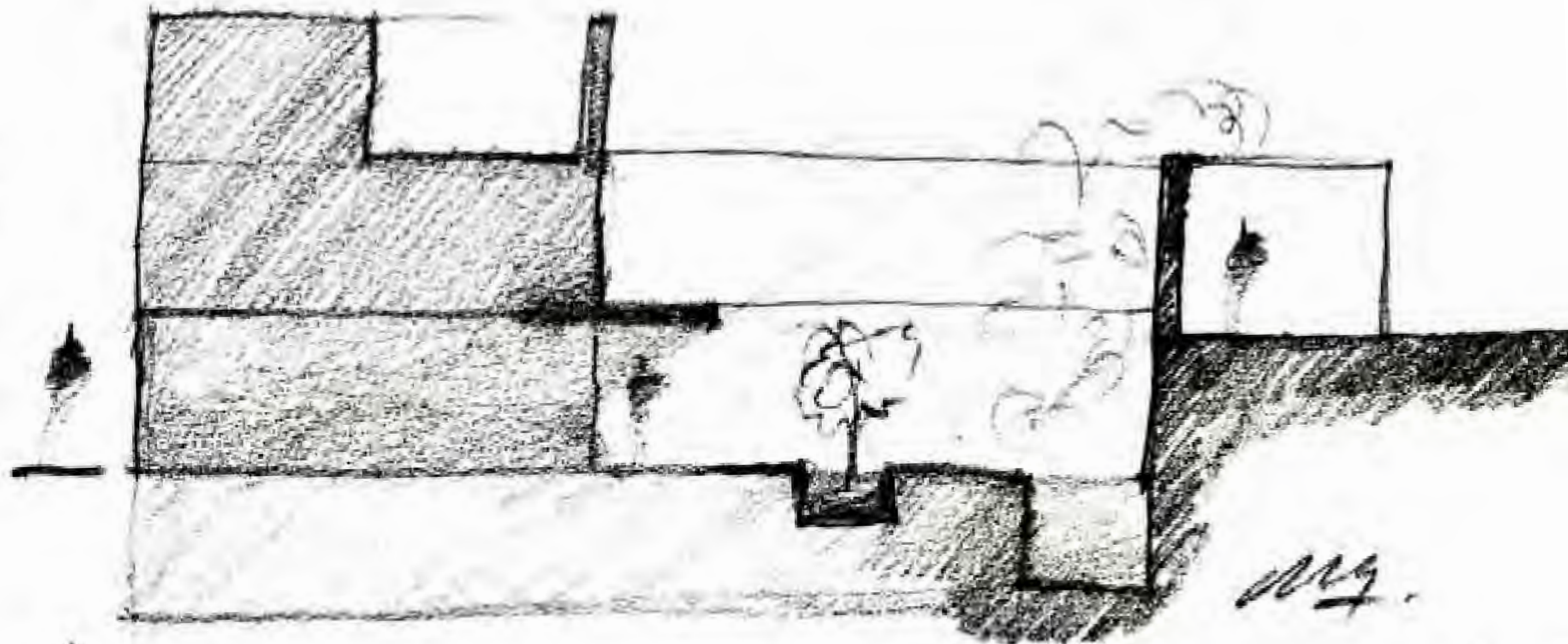
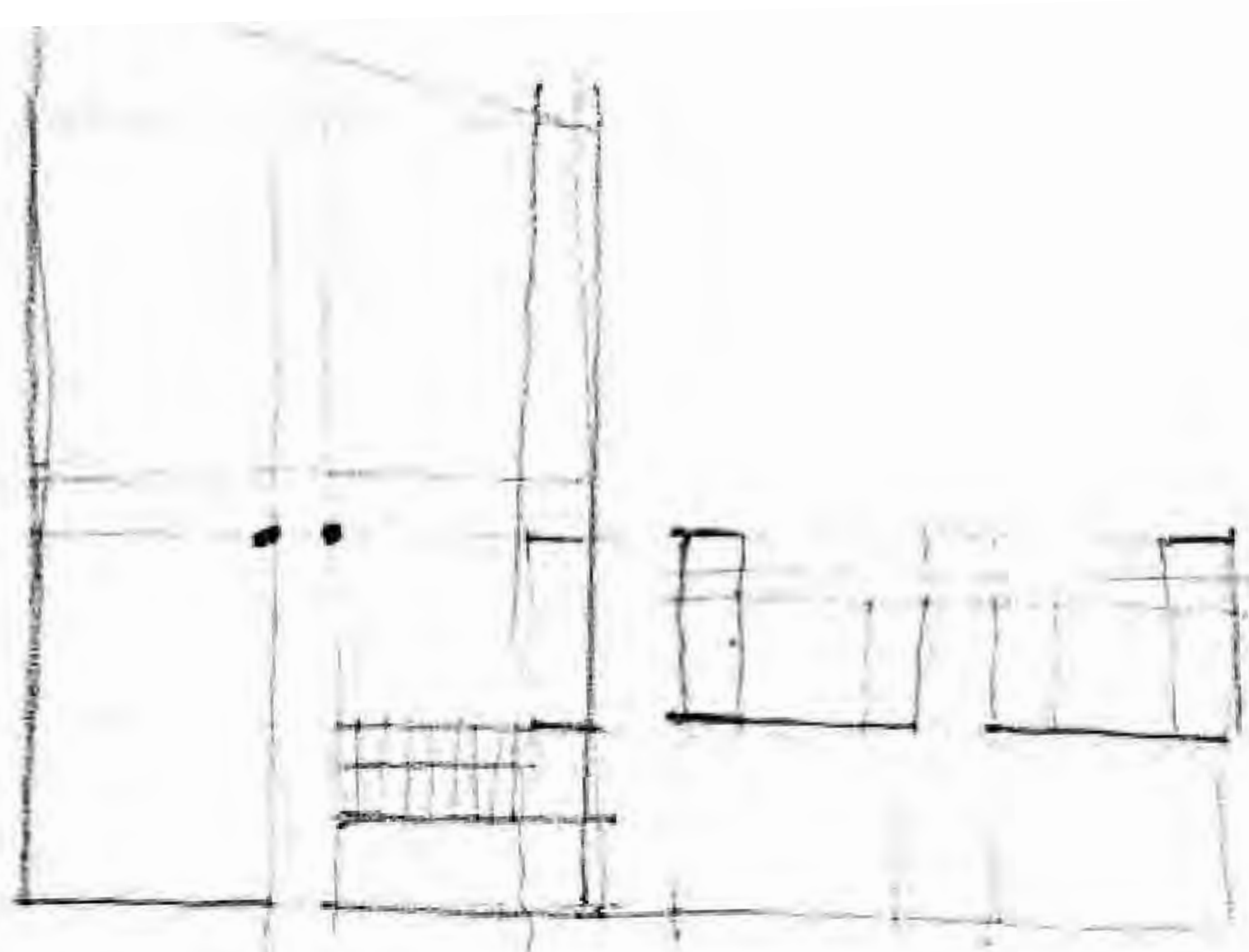

MS.
December 21. 9

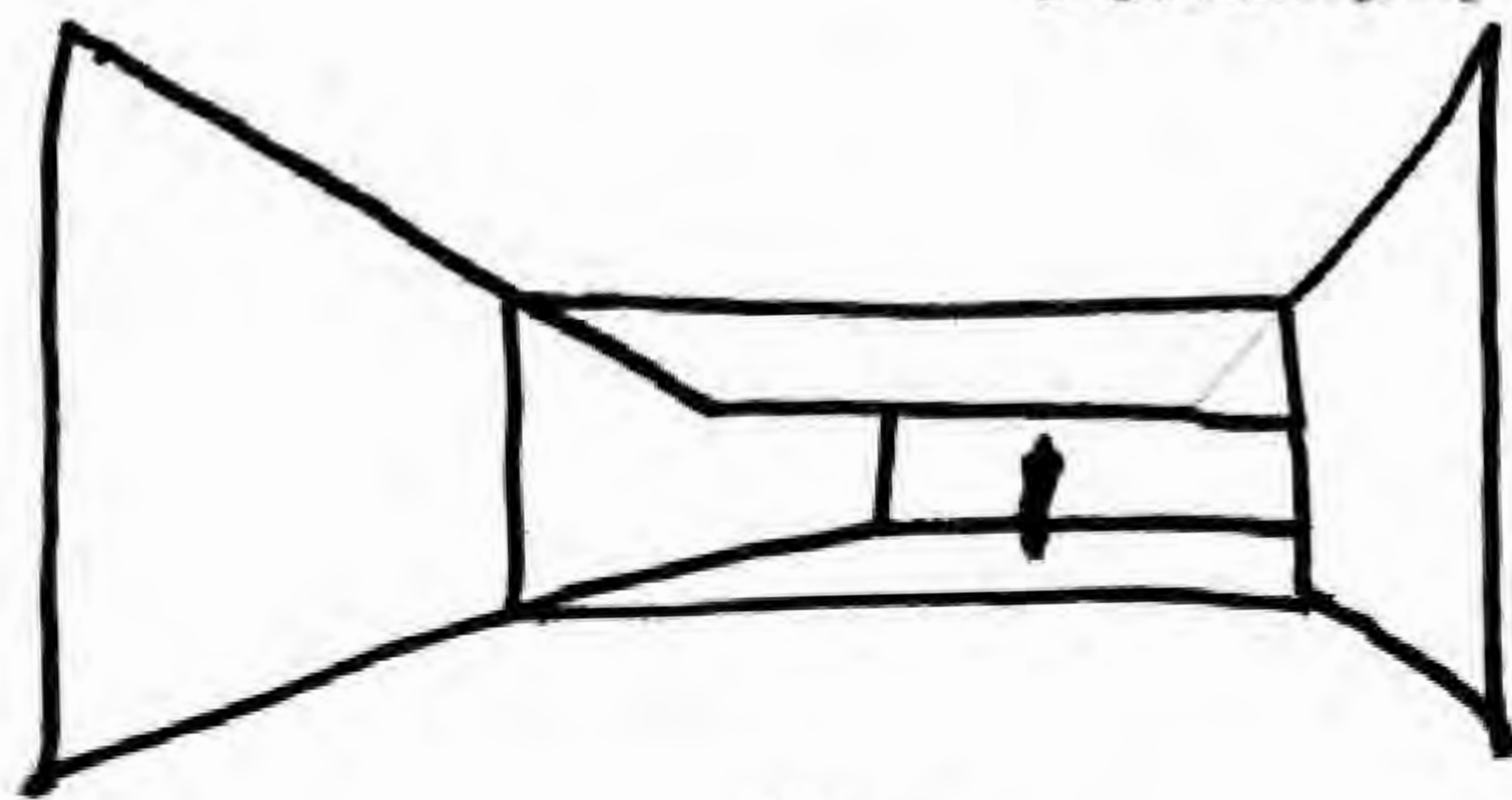
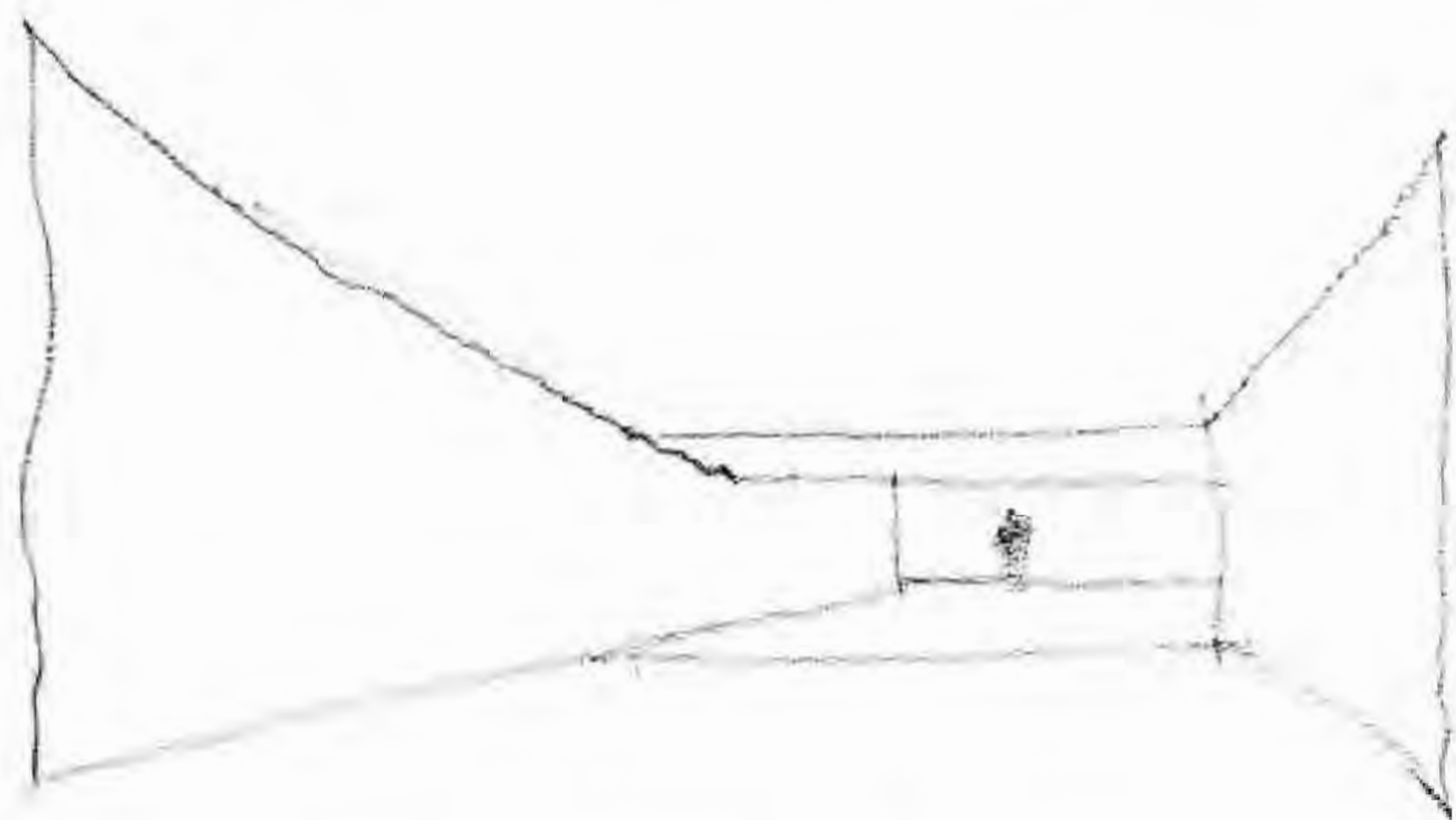

idea: "pequeña casa grande"
"casa abierta al sol"

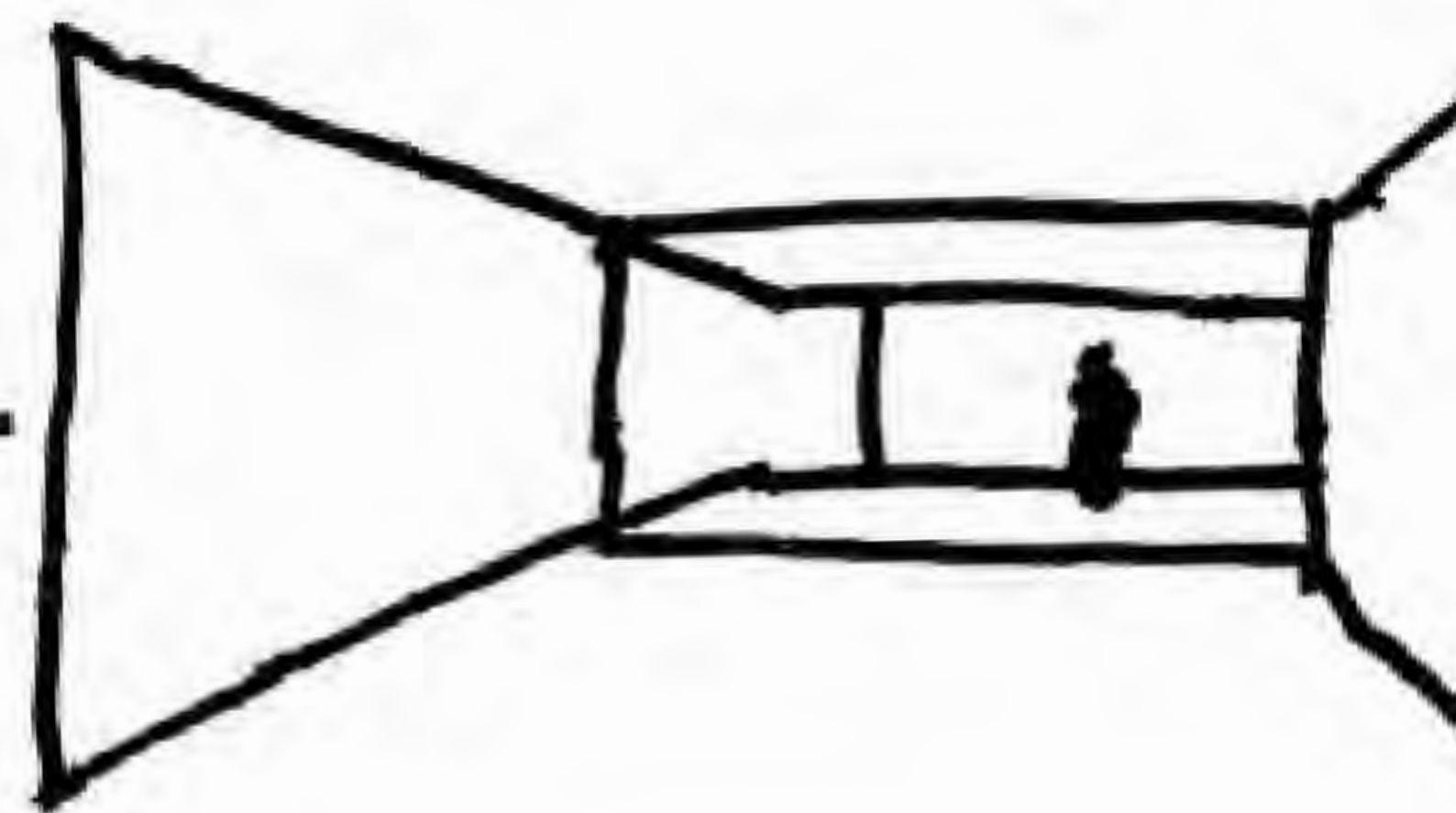

ALEROS

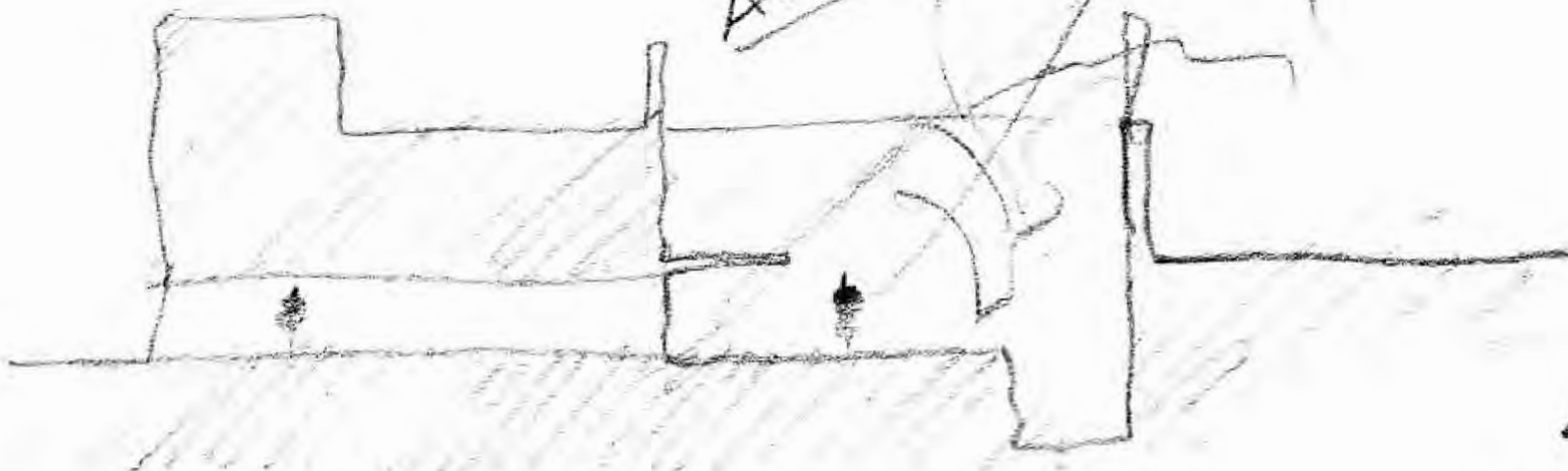

PINO HOUSE - Vicálvaro

MS.
Dec 21. 1992

COAM.

4 urnas + 1 puerta.

↓
con 2 caras.

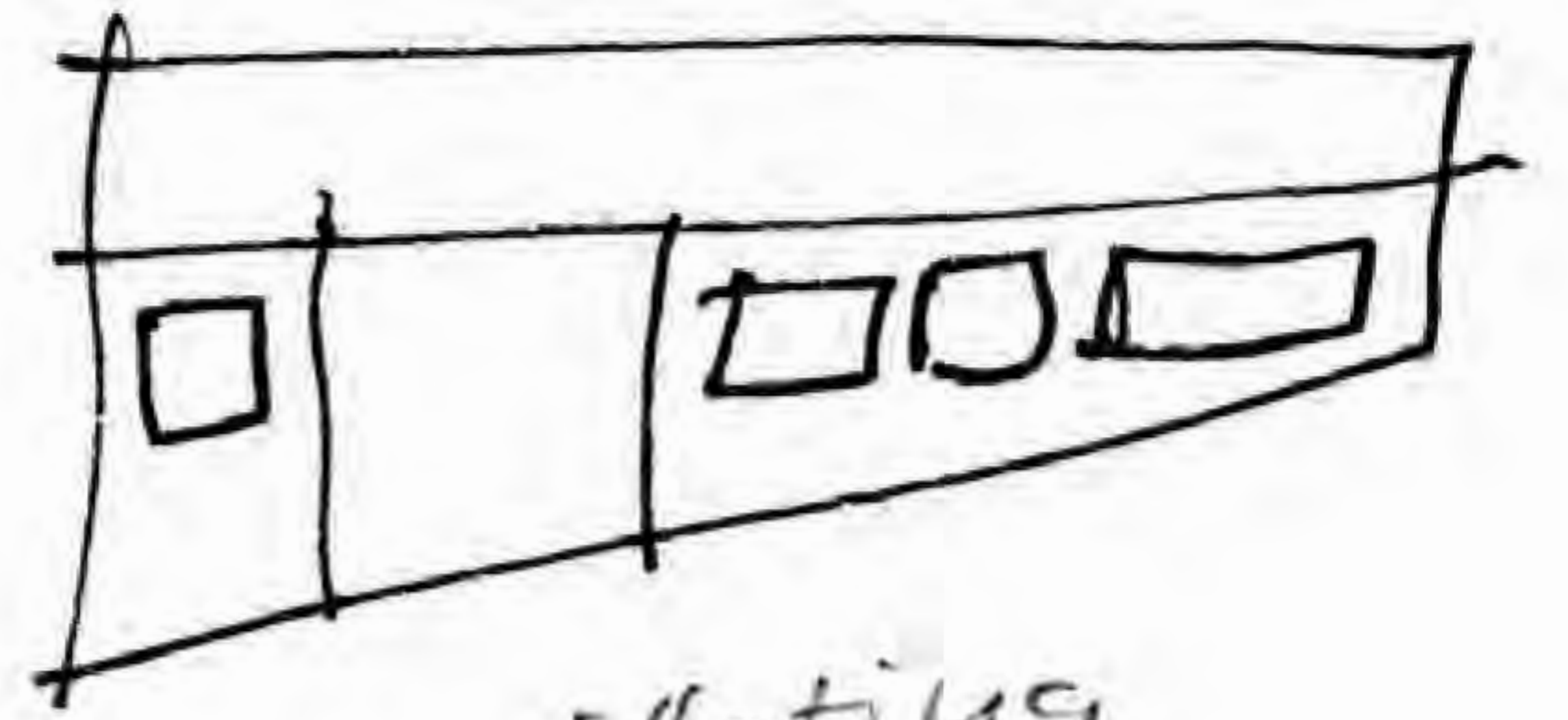

> con carpintería de inox
¡o blanco!

guillotina

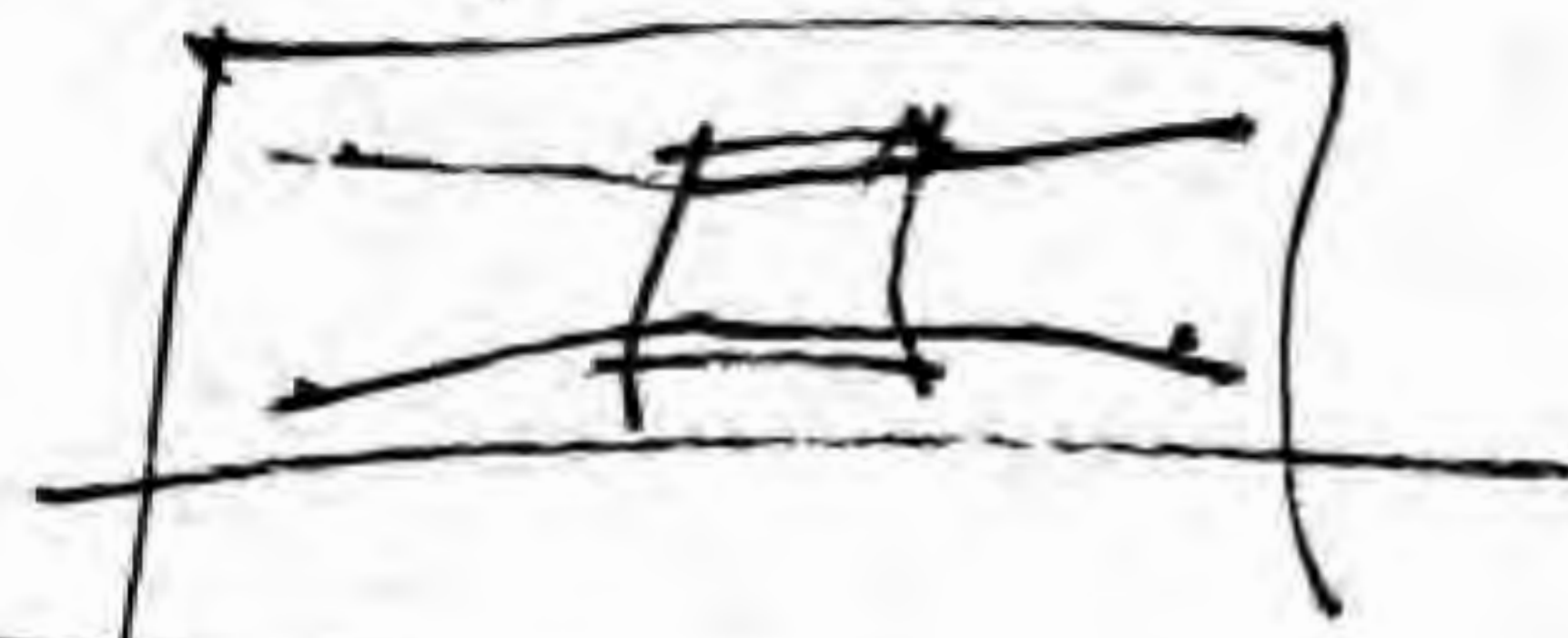
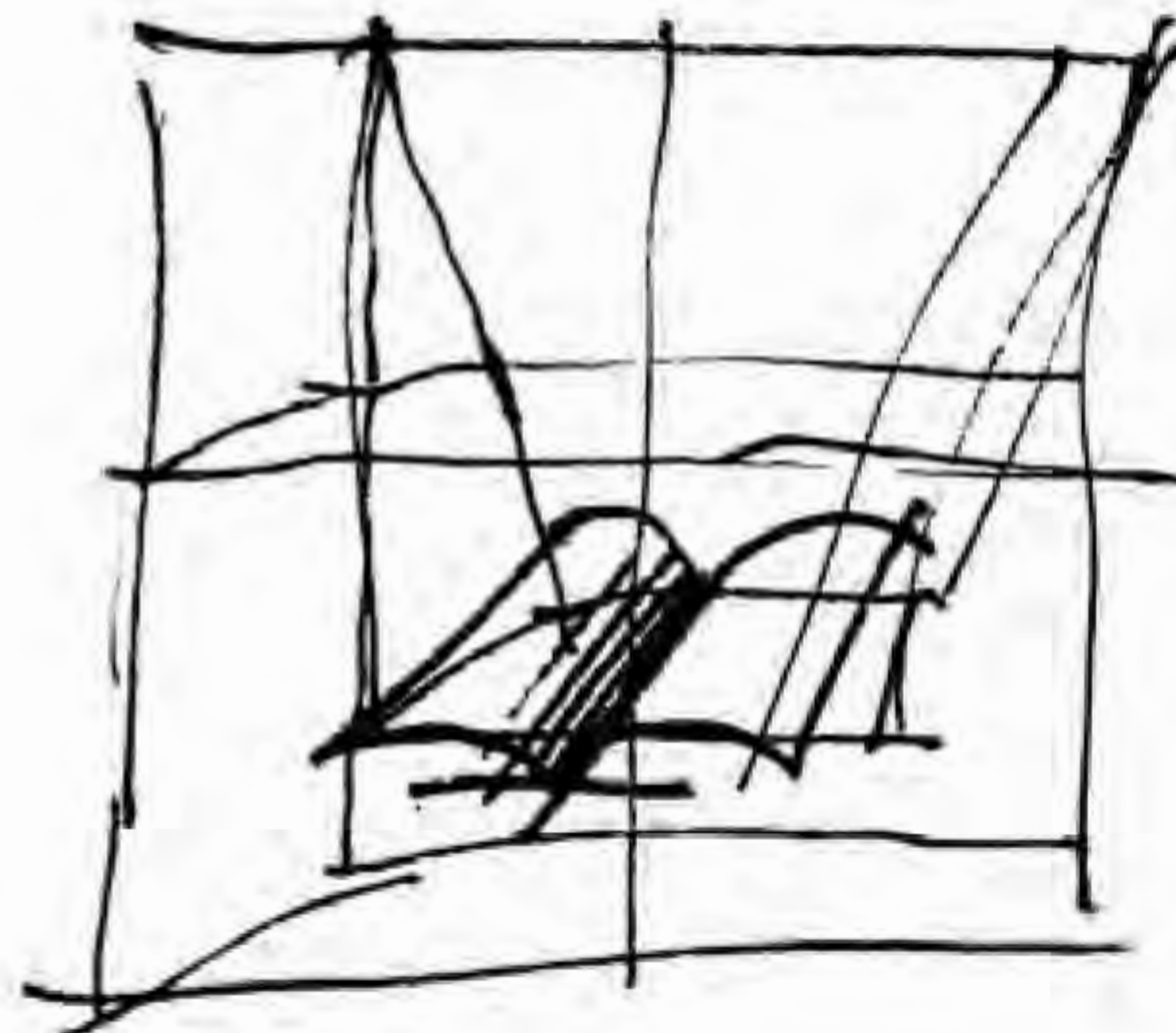
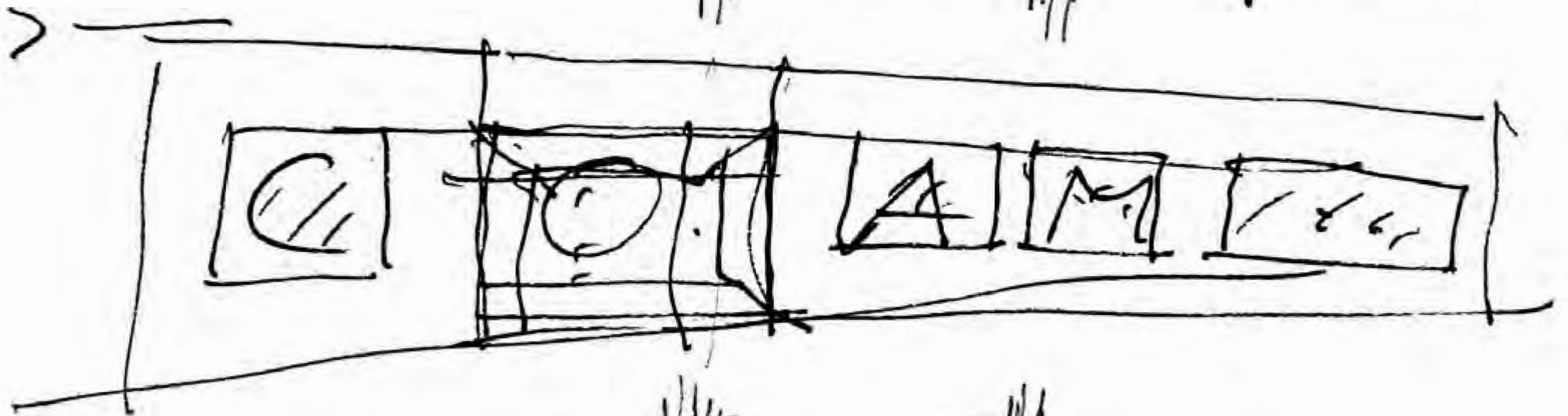

¿uz de ERGO?

> llevarlo.

lot vic

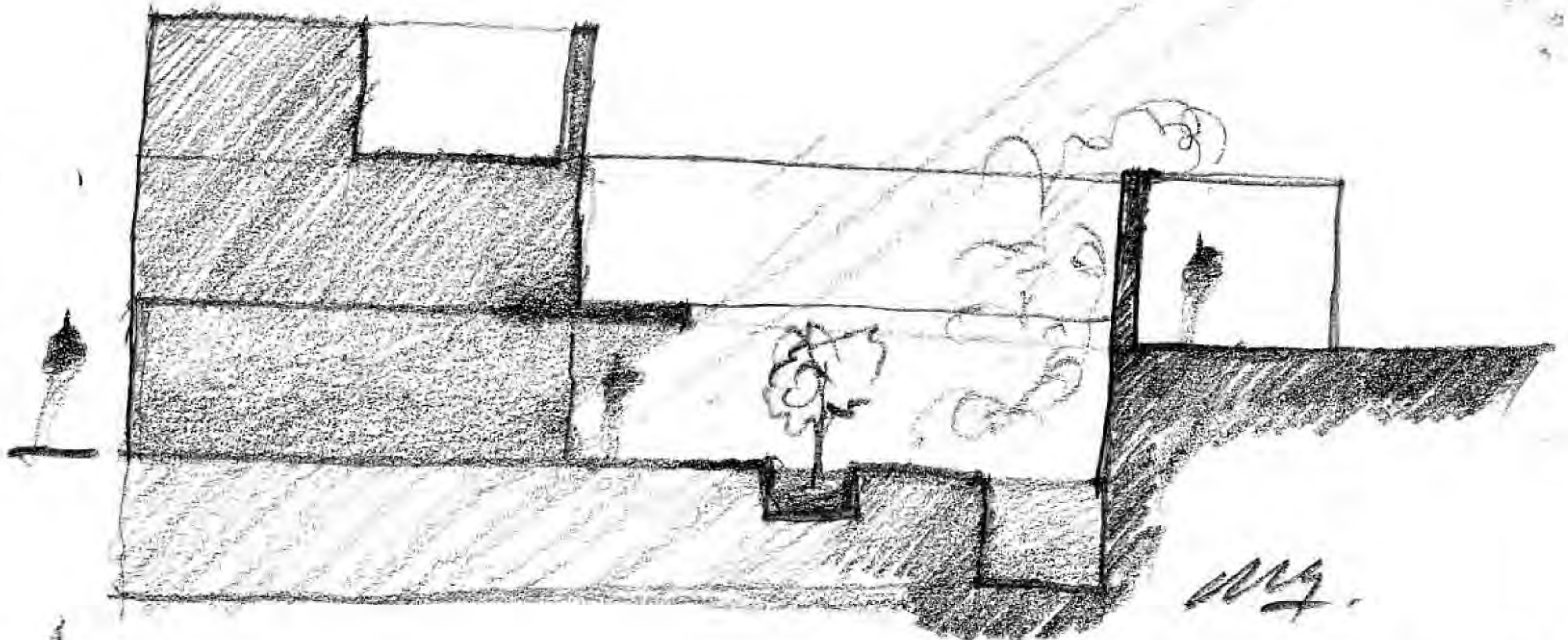
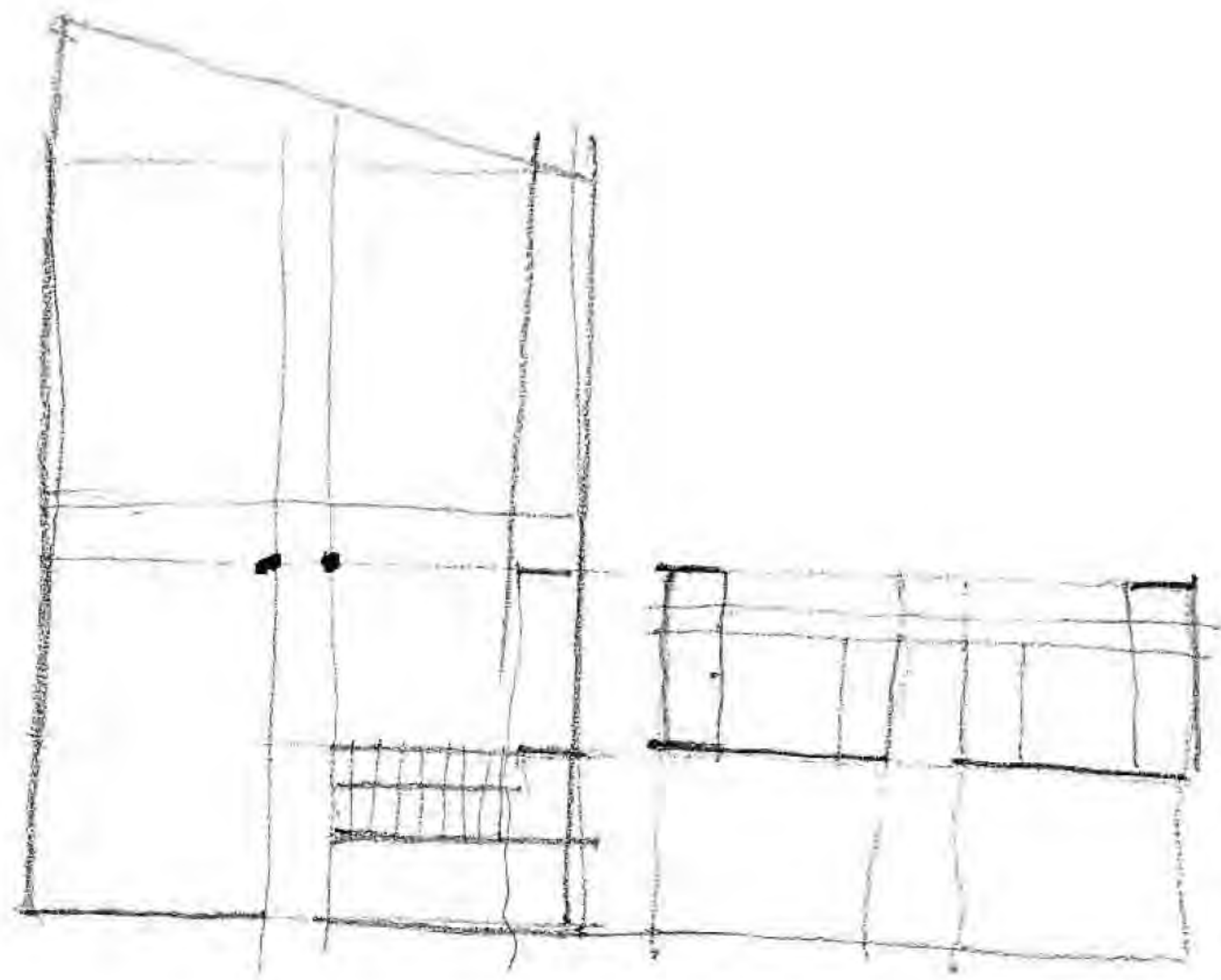

my

December 21, 97

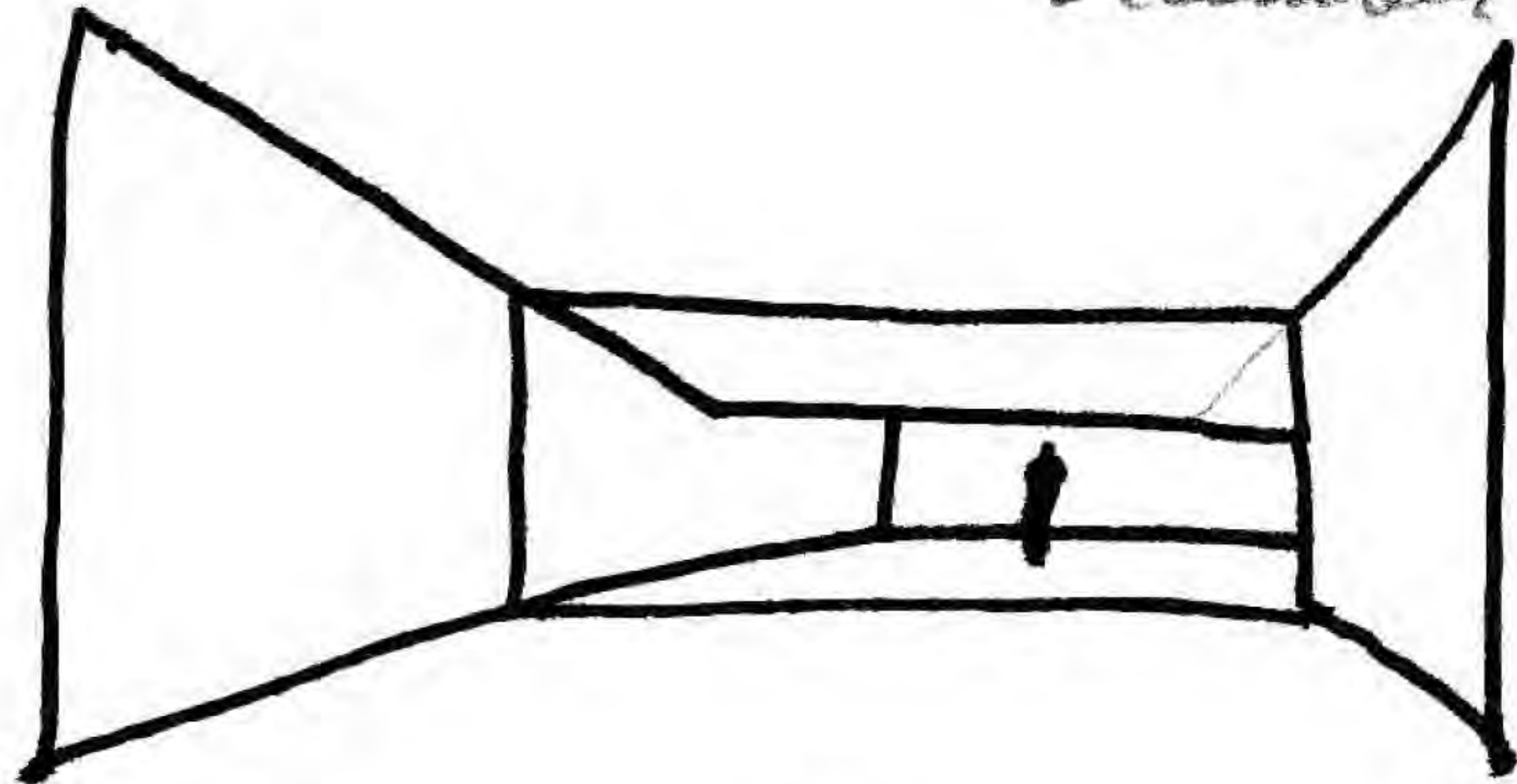
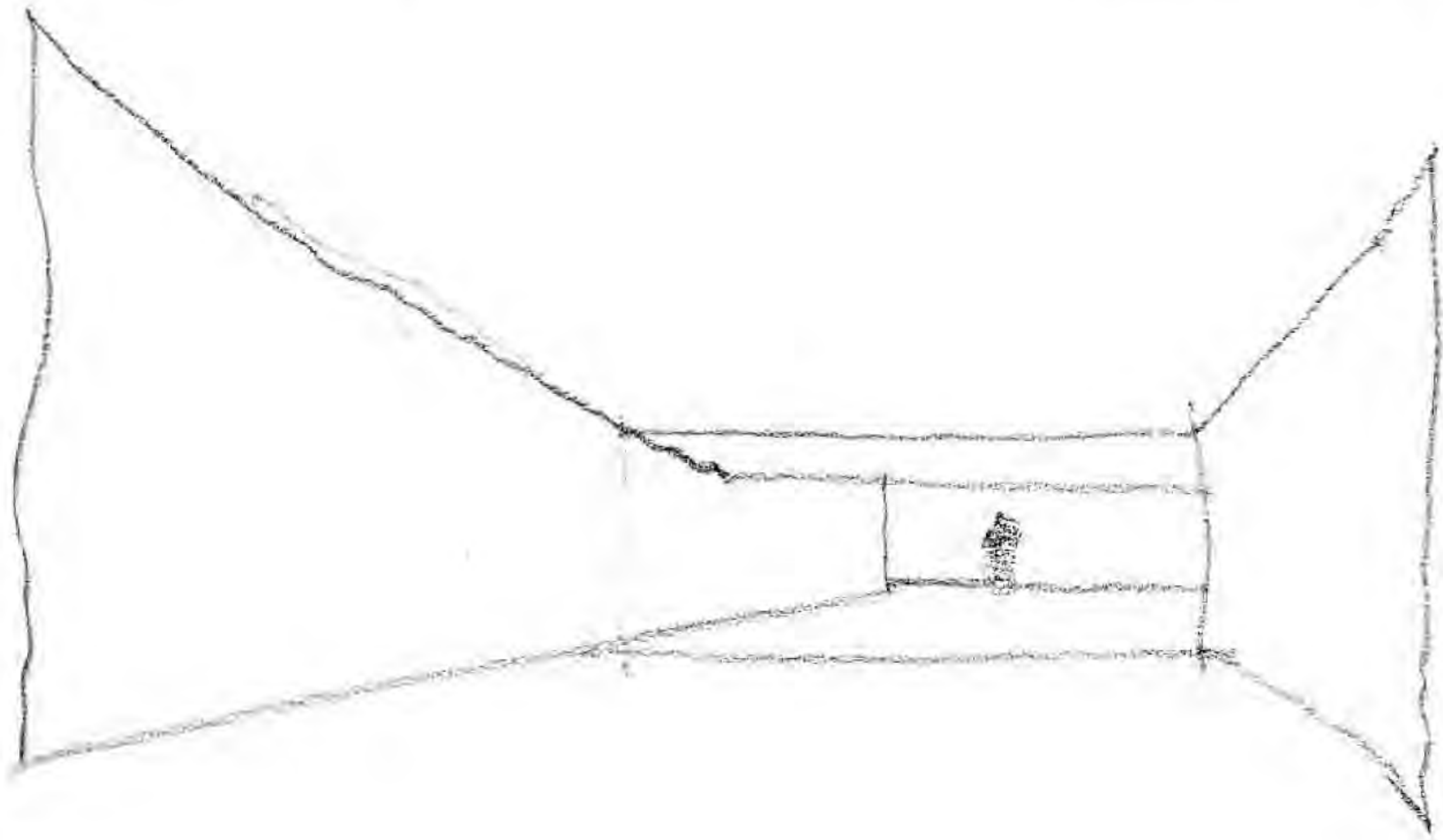

idea: "pequeña casa grande"
"casa abierta al sol"

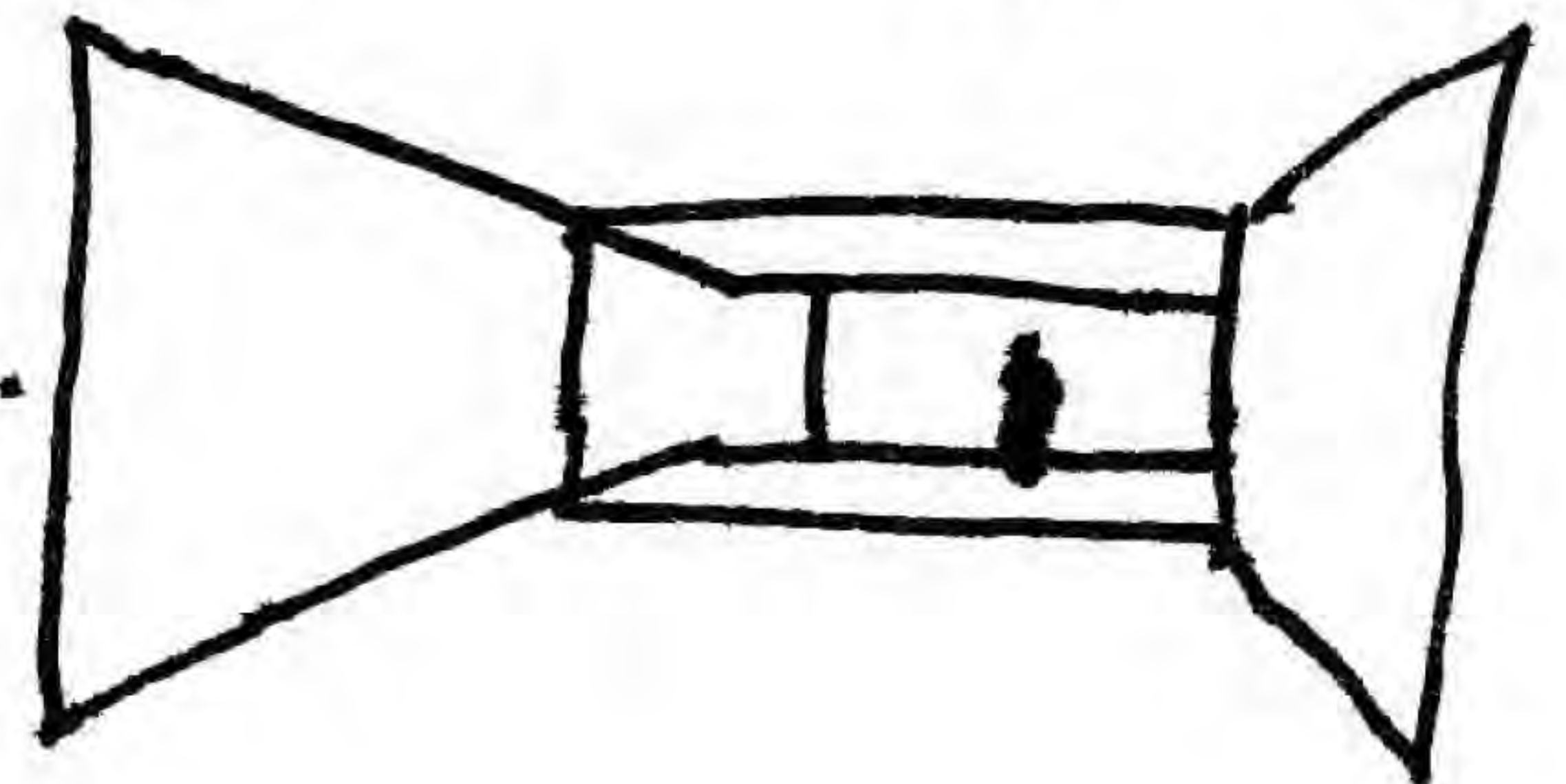

ALEROS

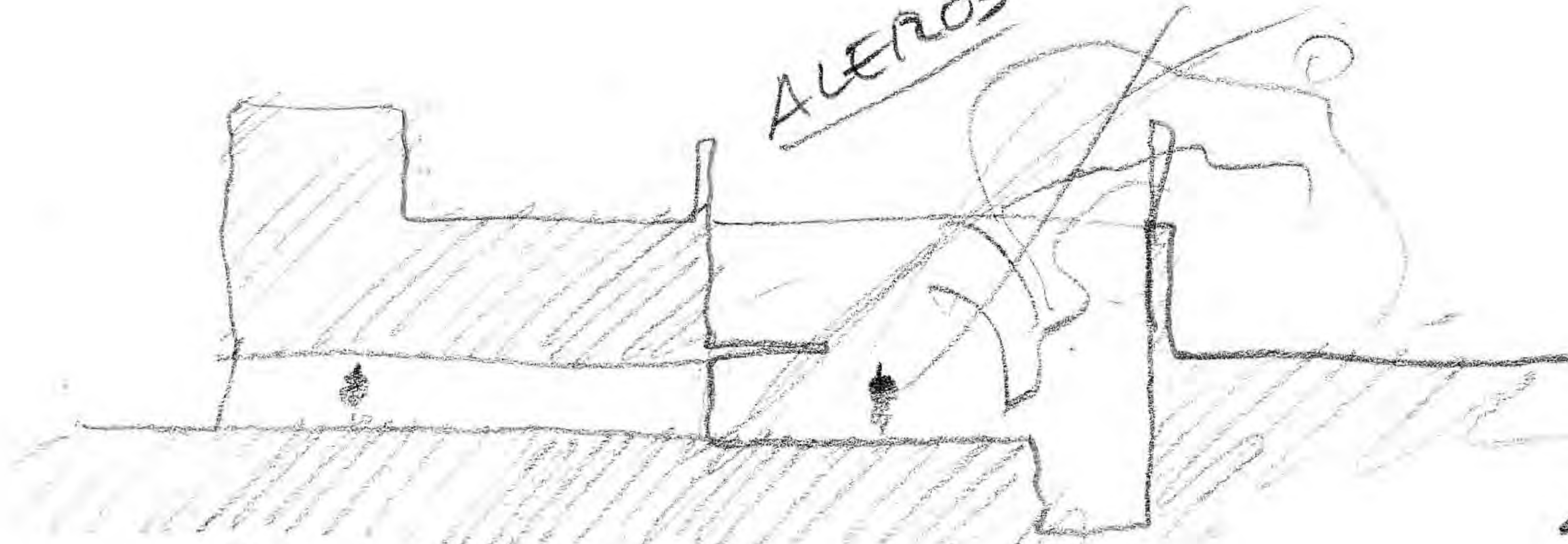

PINO HOUSE - Vicálvaro

my

Dec 21, 1997

11

ALMERÍA -

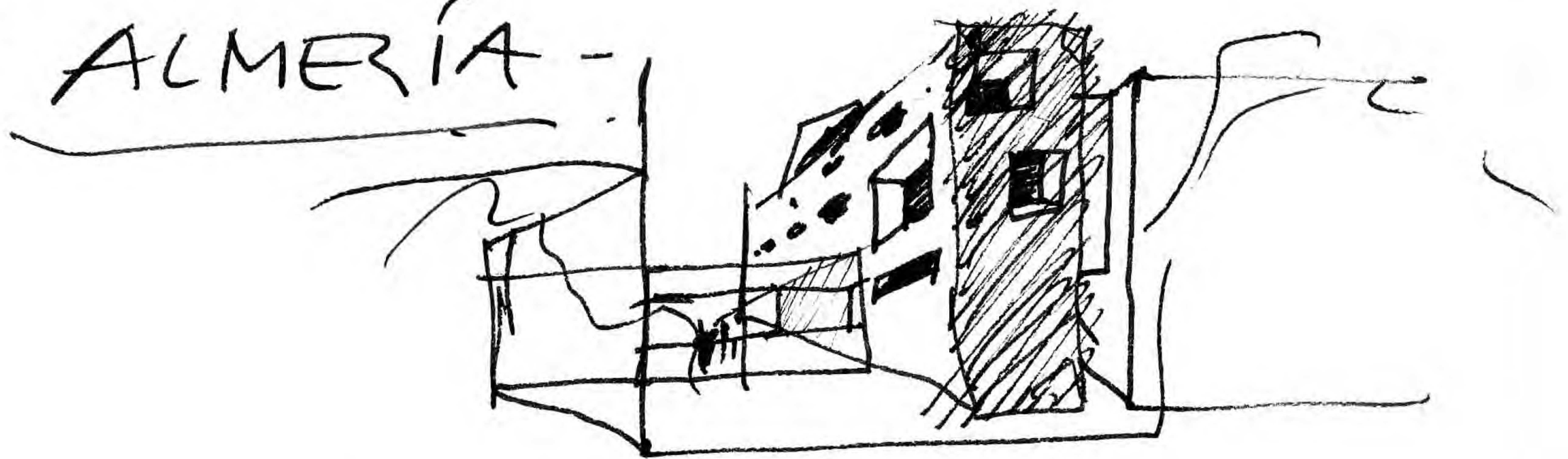

> el vestíbulo al vidrio
a través el muro de piedra.

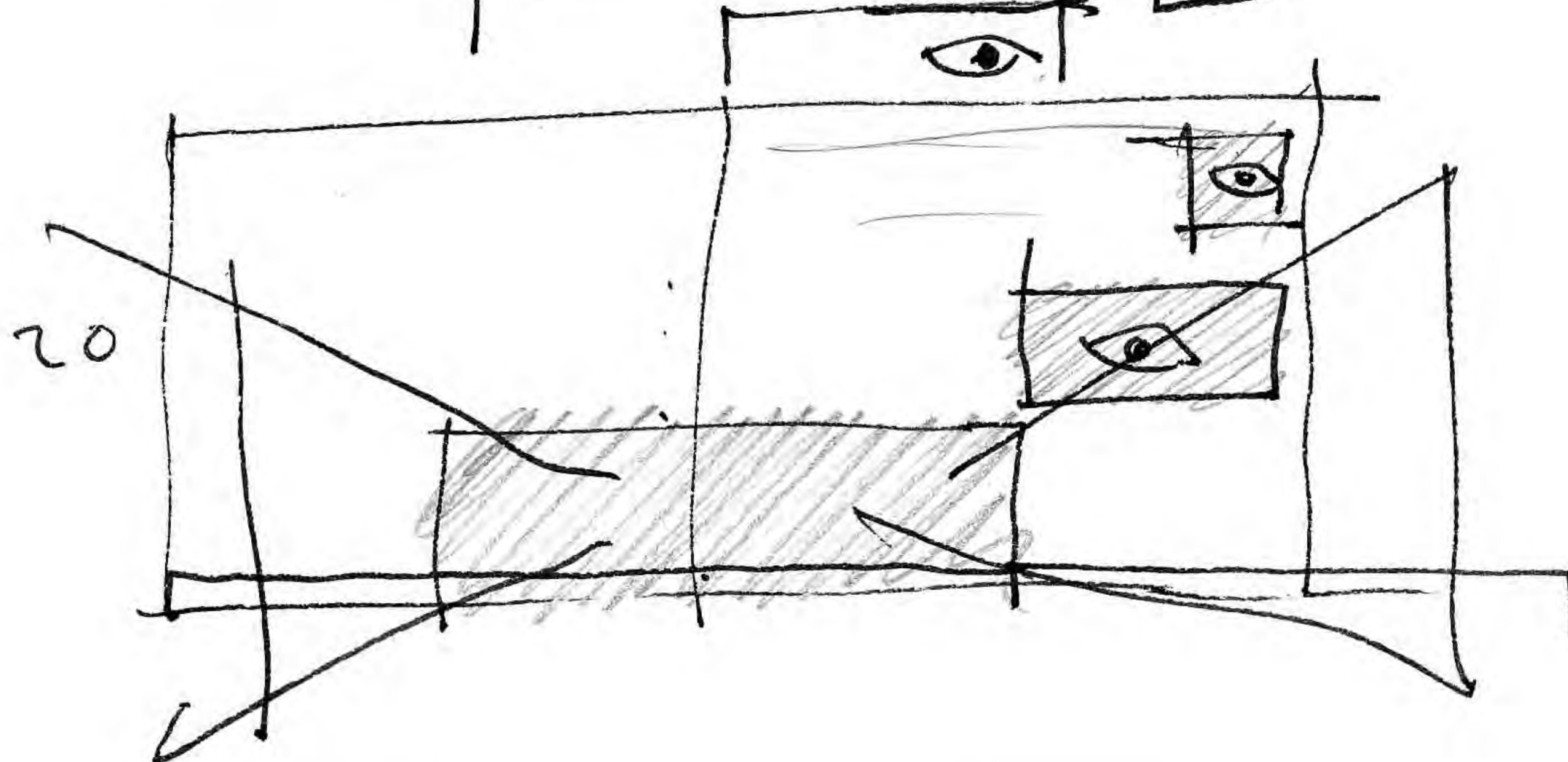
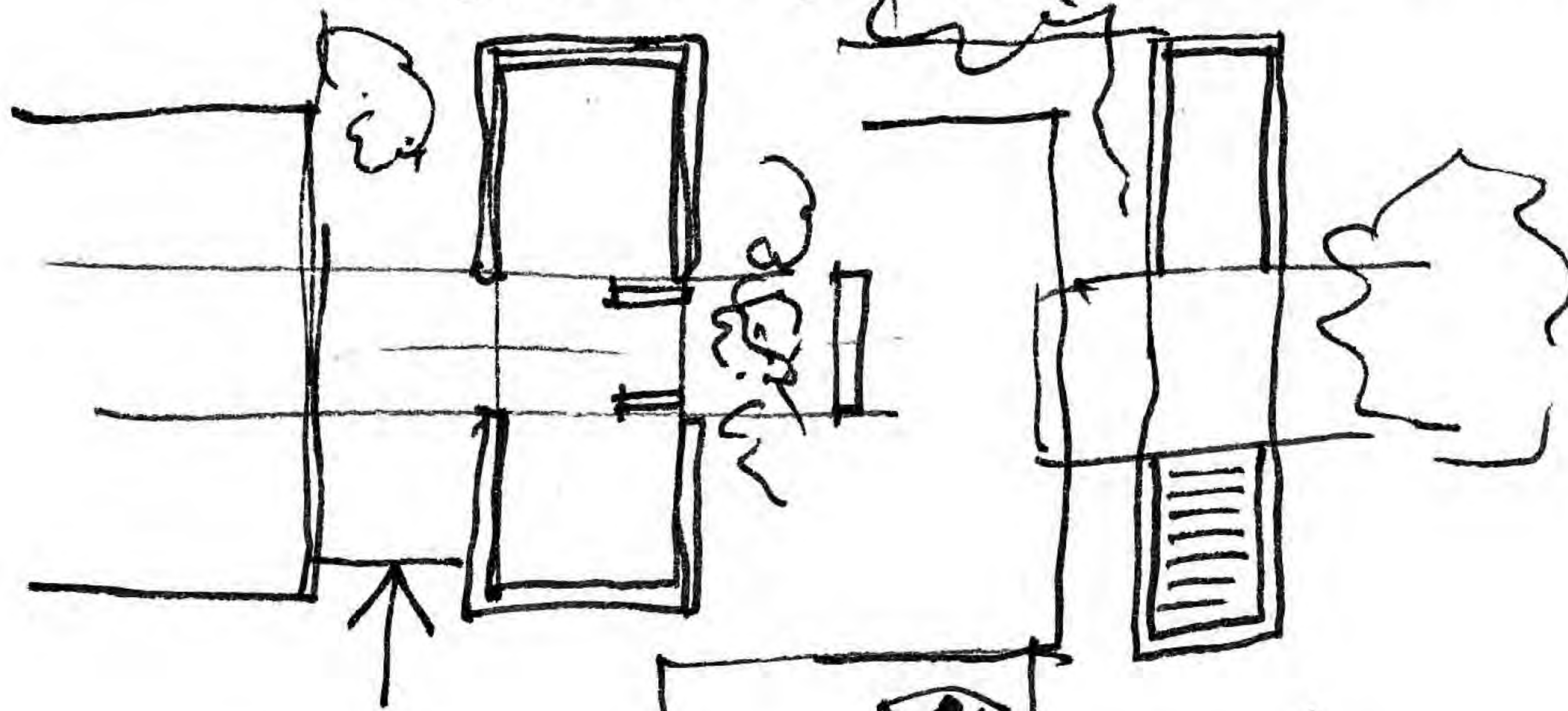

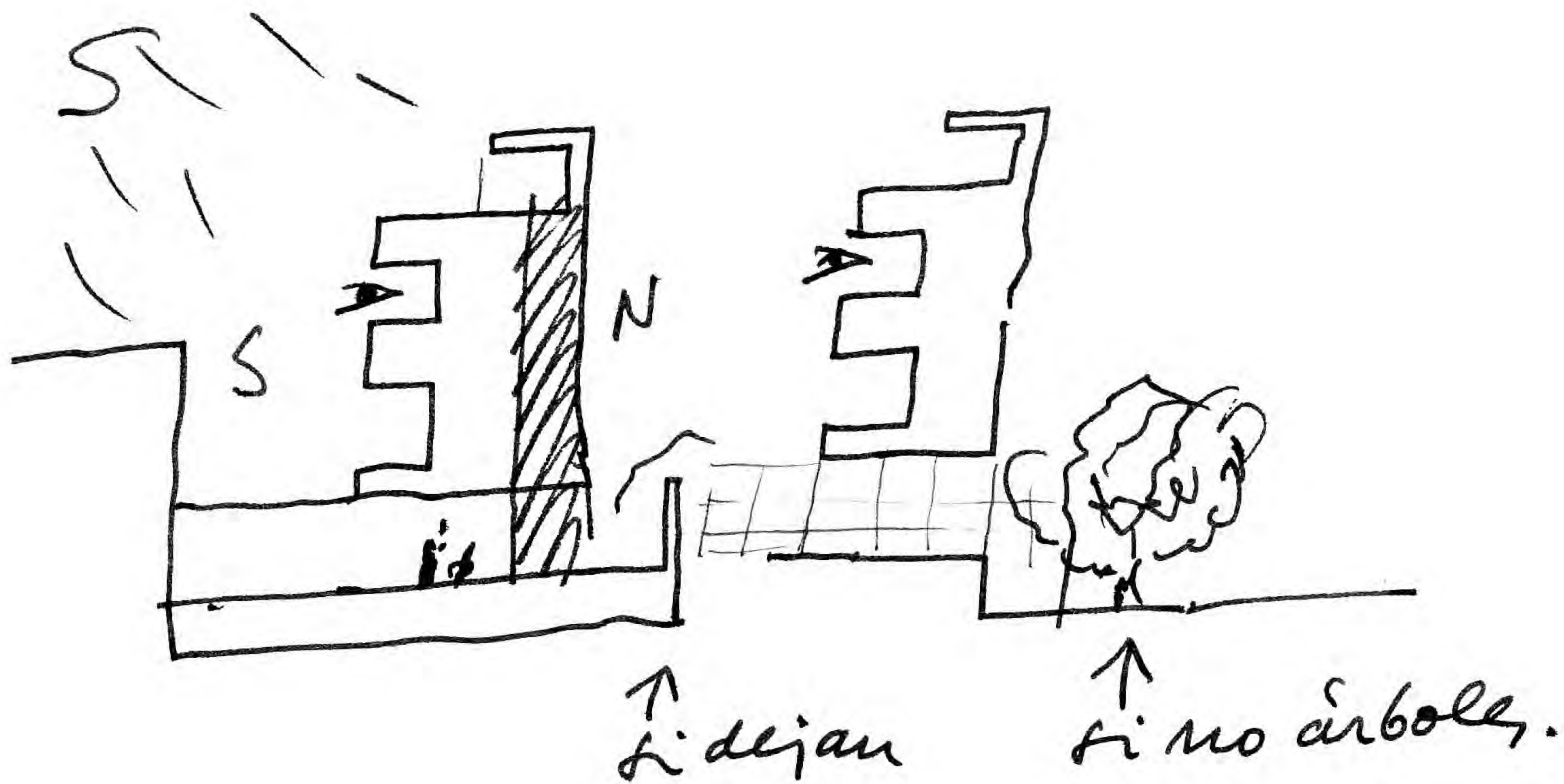

Dec. 21. 1992.

> Almacenar.

· caja en piedra, con 2 cajas de vidrio

· que se abre y cierra

(· pies - más pesado. / ∇)

· cabera - más ligero / \uparrow)

> la pared divisora a norte.

> estructura.

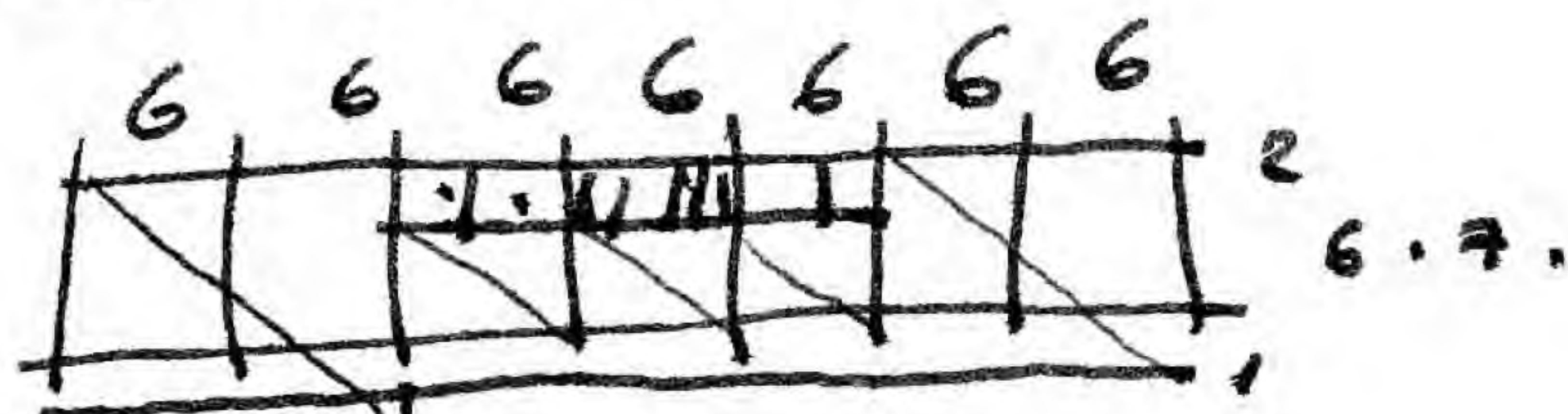

$7 \times 6 = 42.$

$8 \times 5 =$

40

Fue un atardecer del 22 de diciembre del 1997
esperando a tomar cámara para tubular "columbacio"
de las P. en Cádiz"

La luz de la tarde es muy especial y se ve
plácida pero parece que con, segundos aún de
interior, el día más corto, se irá empinando.
Los ucarinos en Cádiz ya han empezado con
hojas nuevas verde claro. Pasan perros blancos
y sus amos, que no los son tanto. Desde aquí
se ven, entre gente y garita, las grúas del muelle

CD

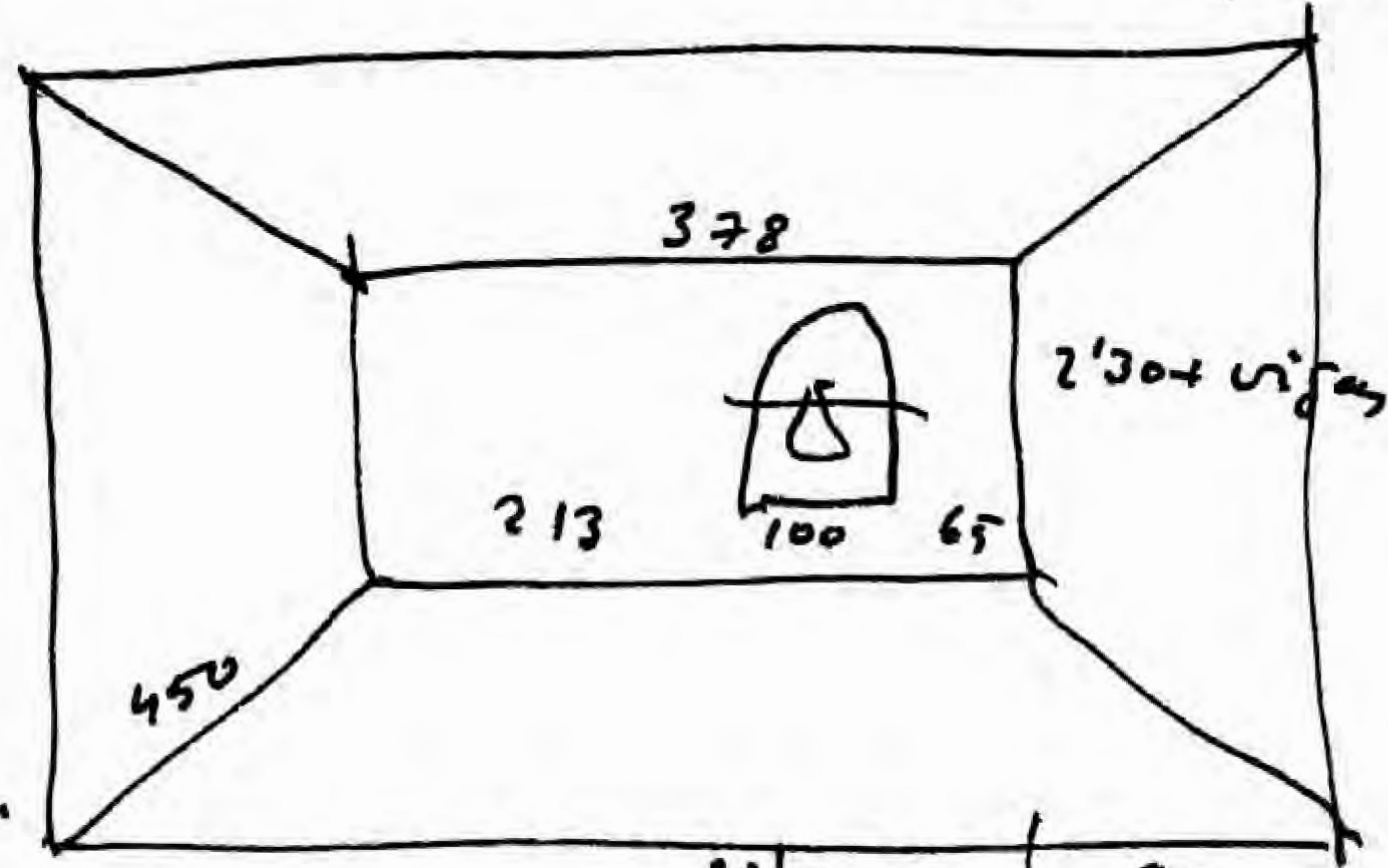

Cádiz
24. dic. 1997.

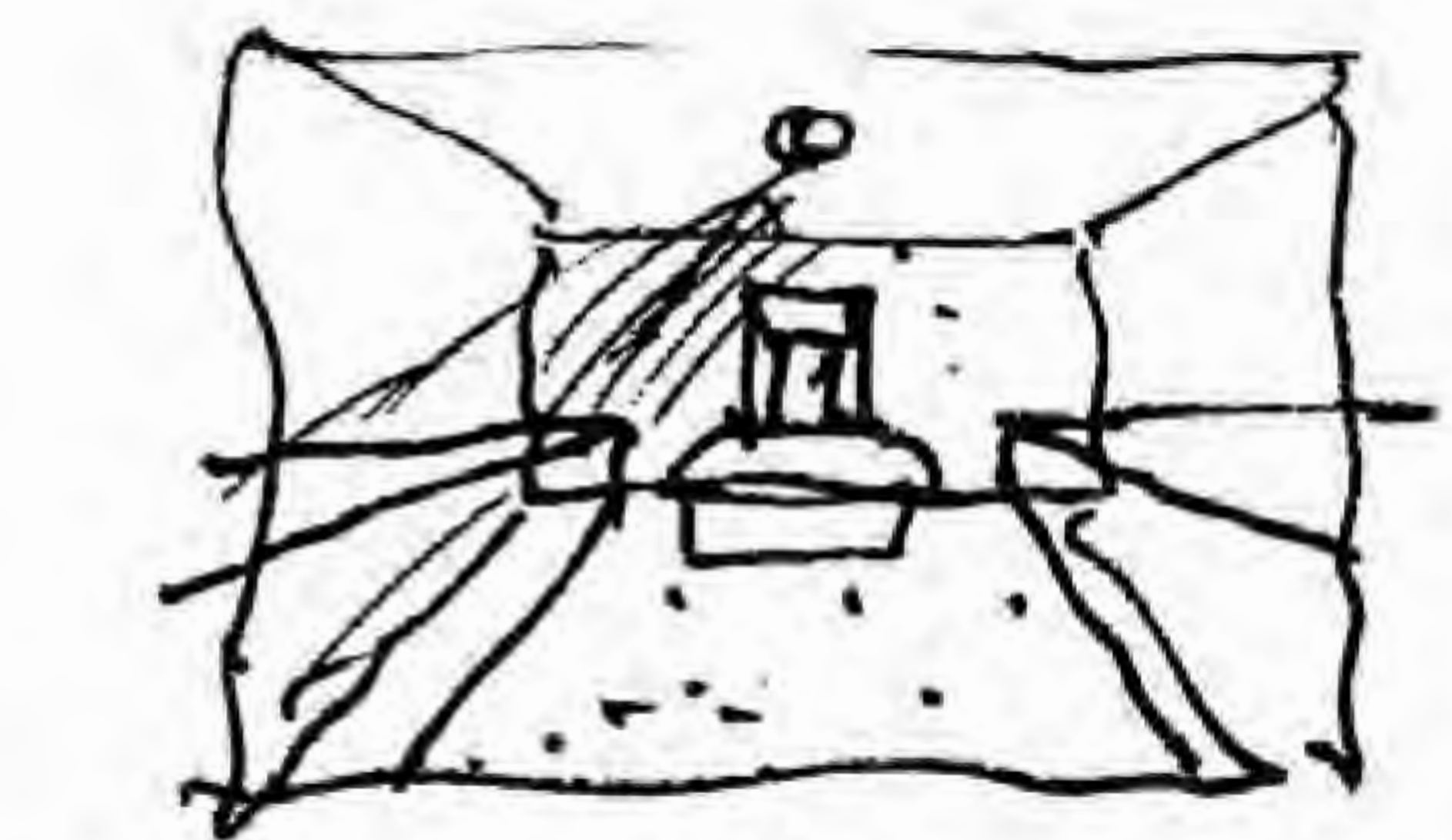
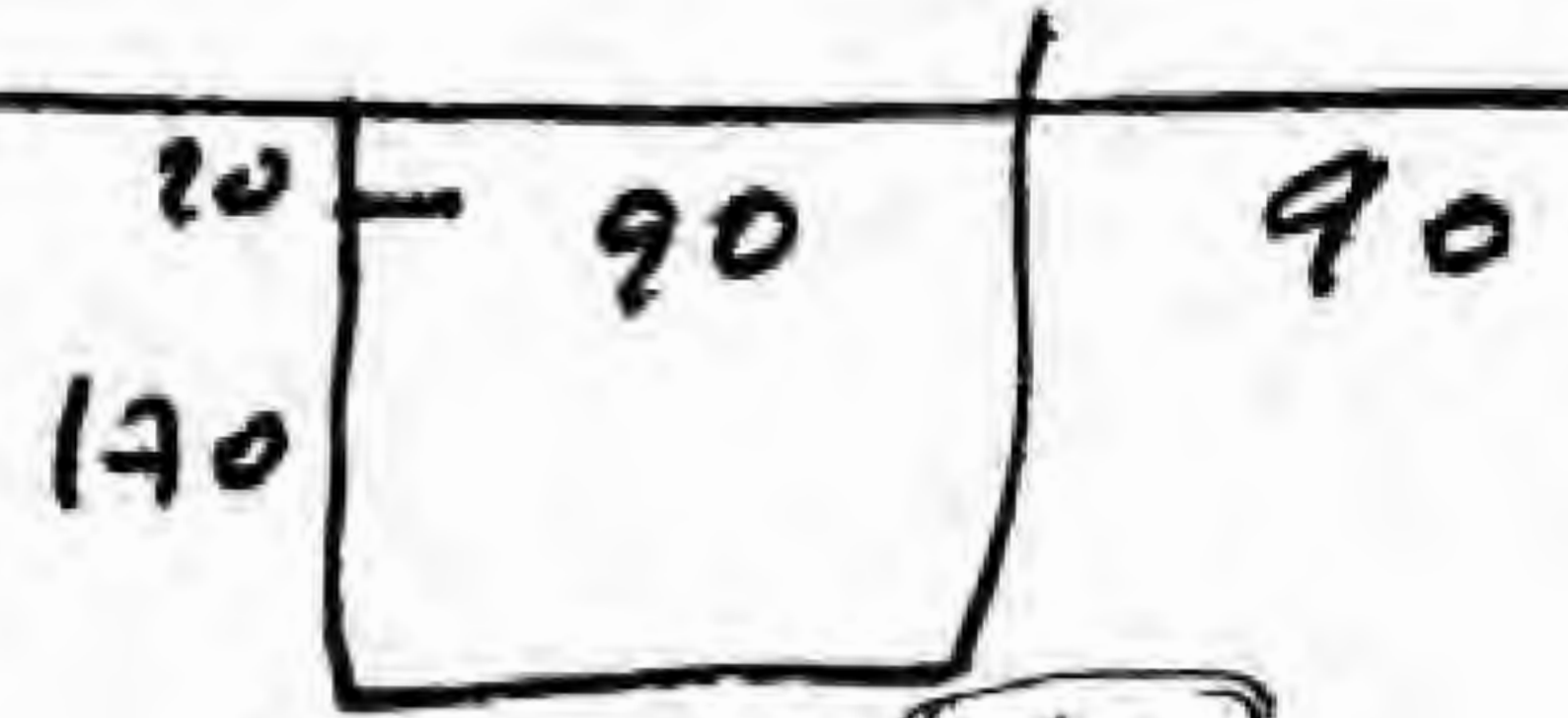

axialidad.



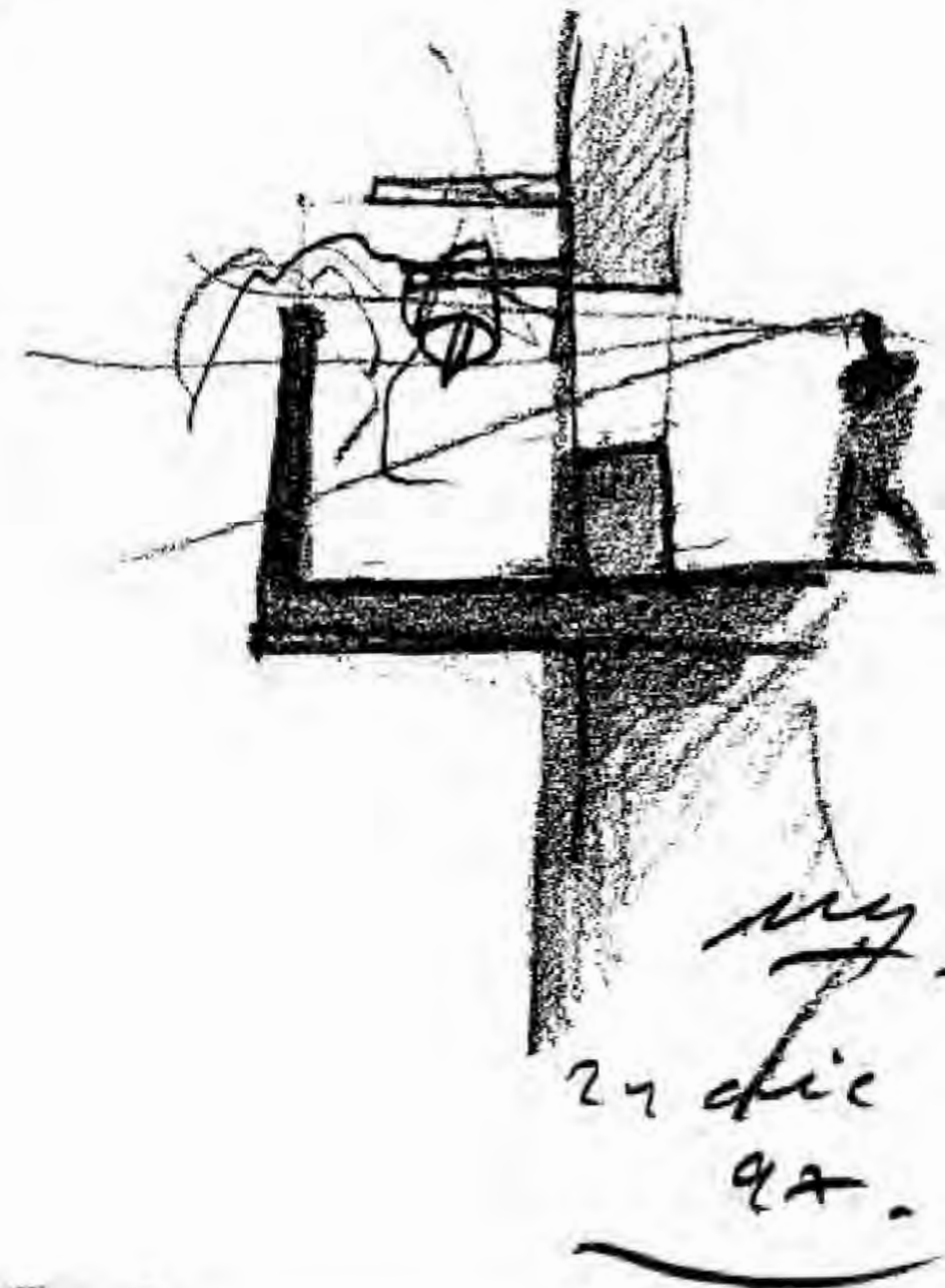
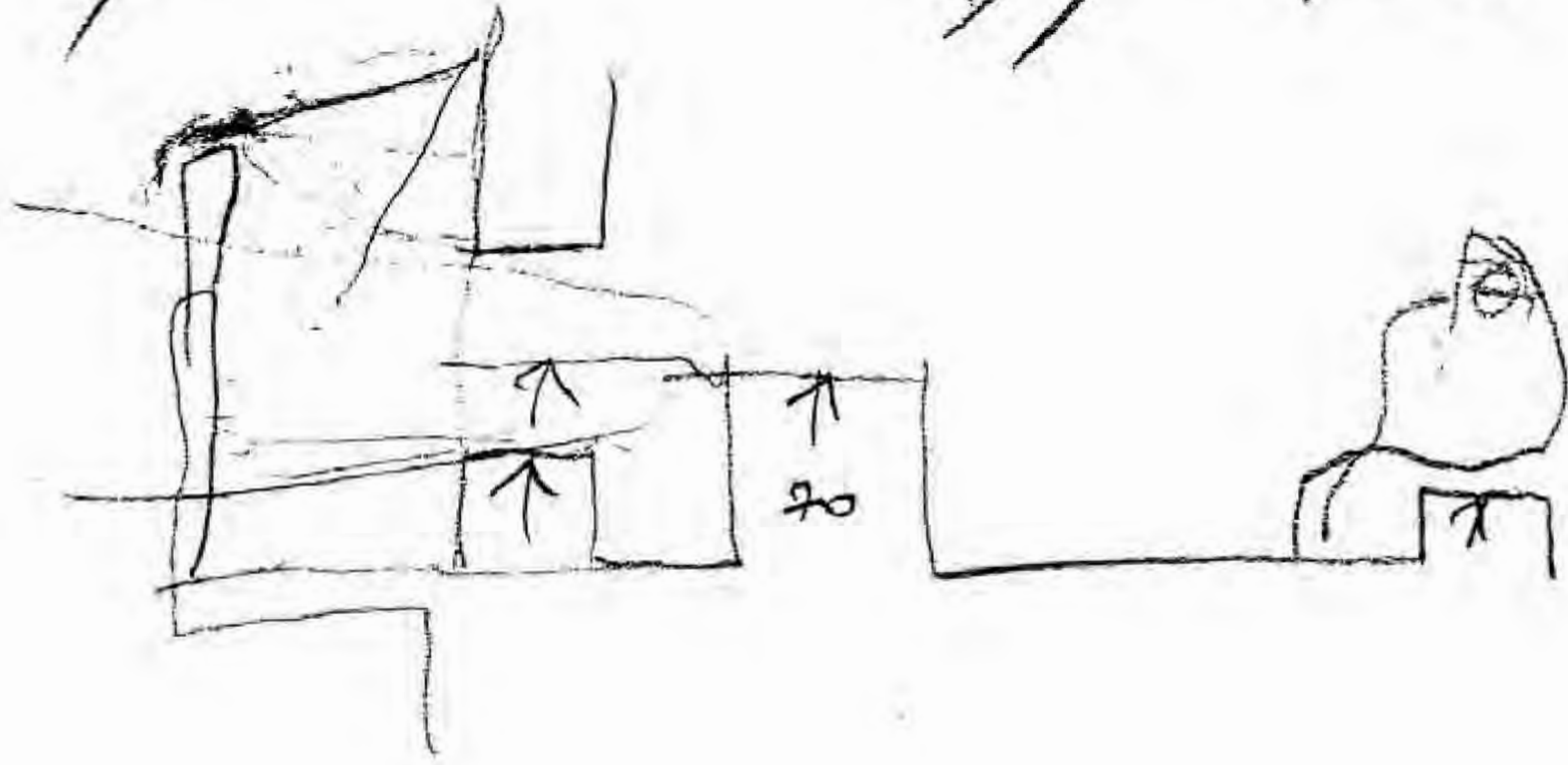
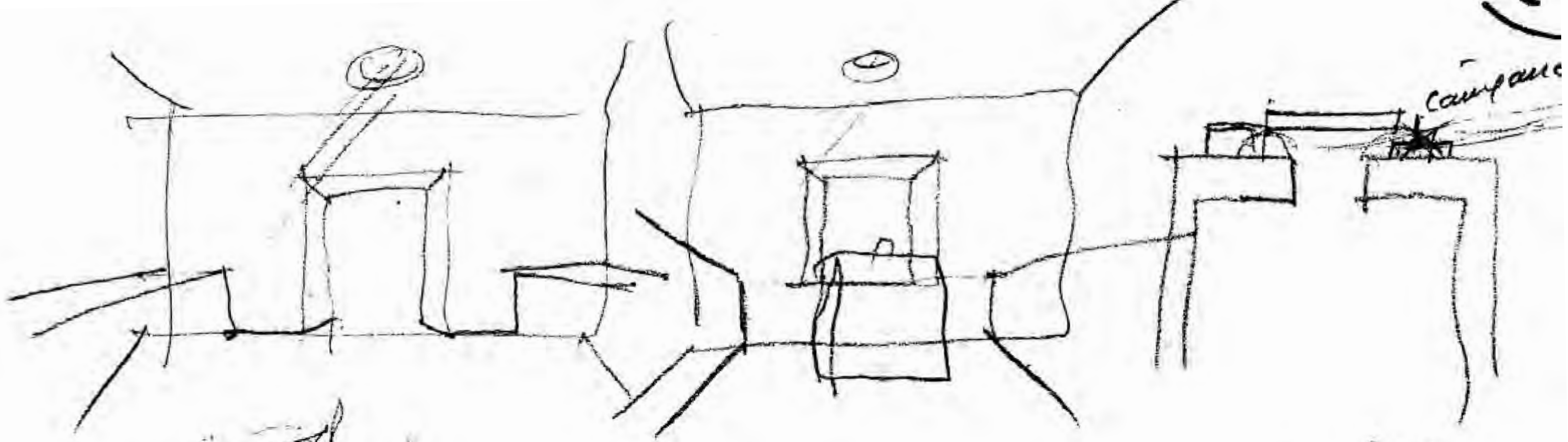

7 camp.

7 Columbario

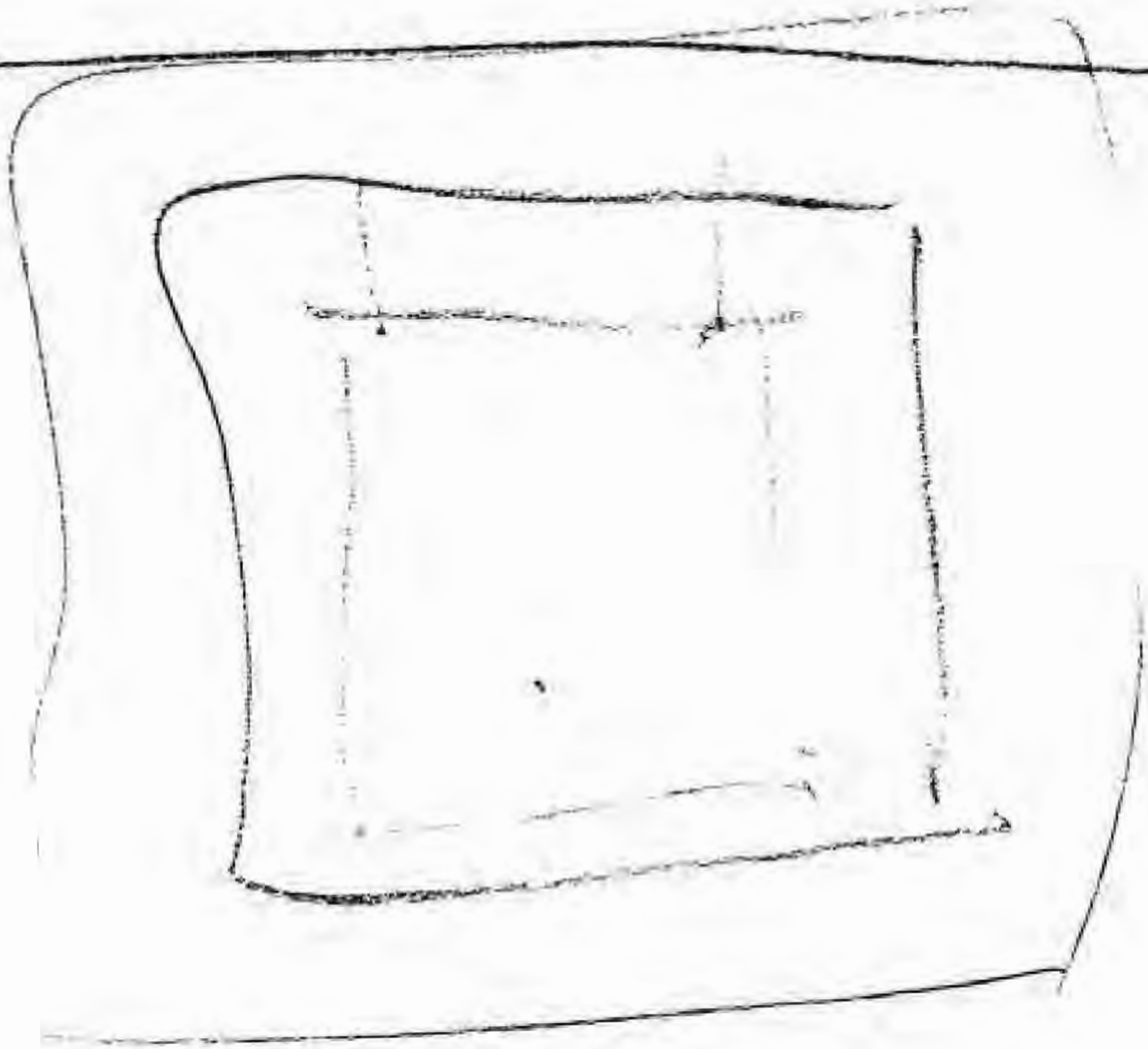

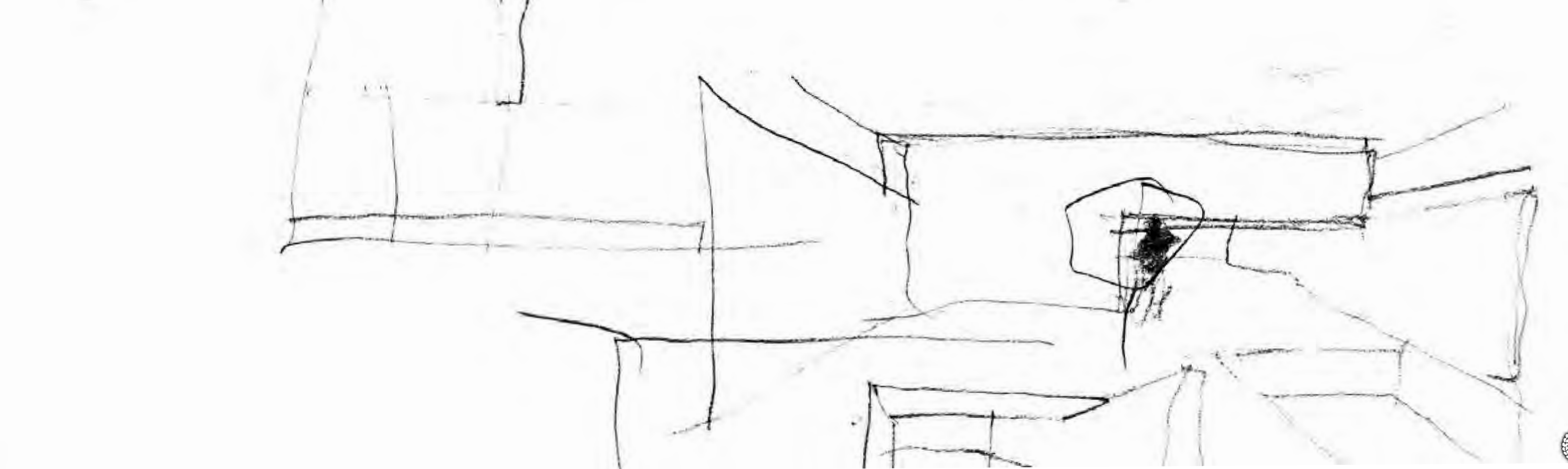
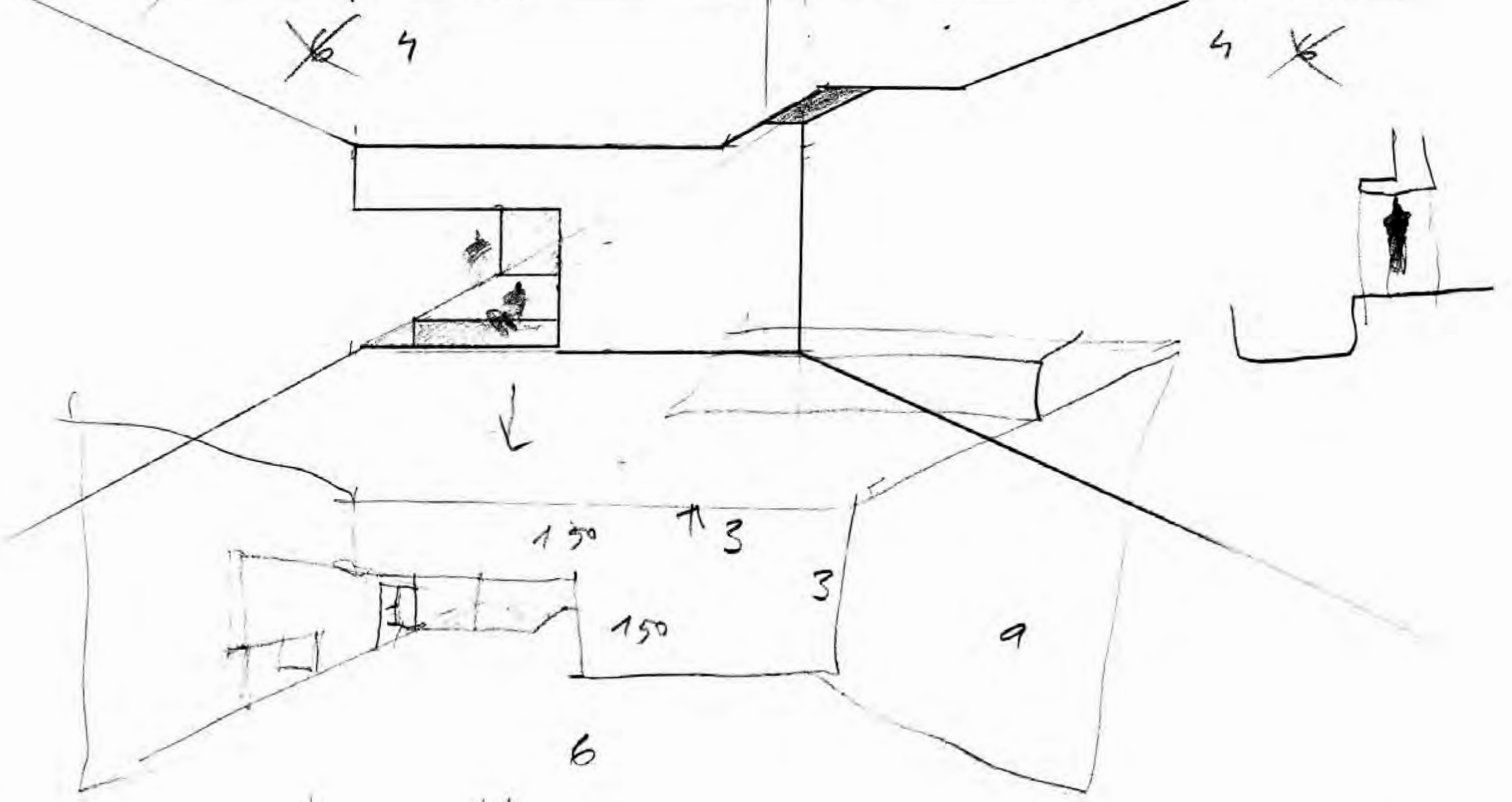
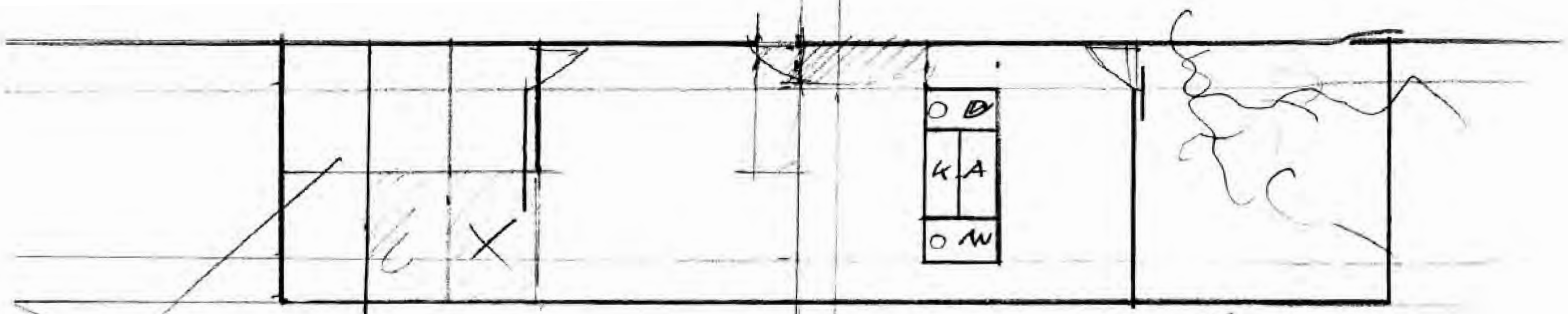

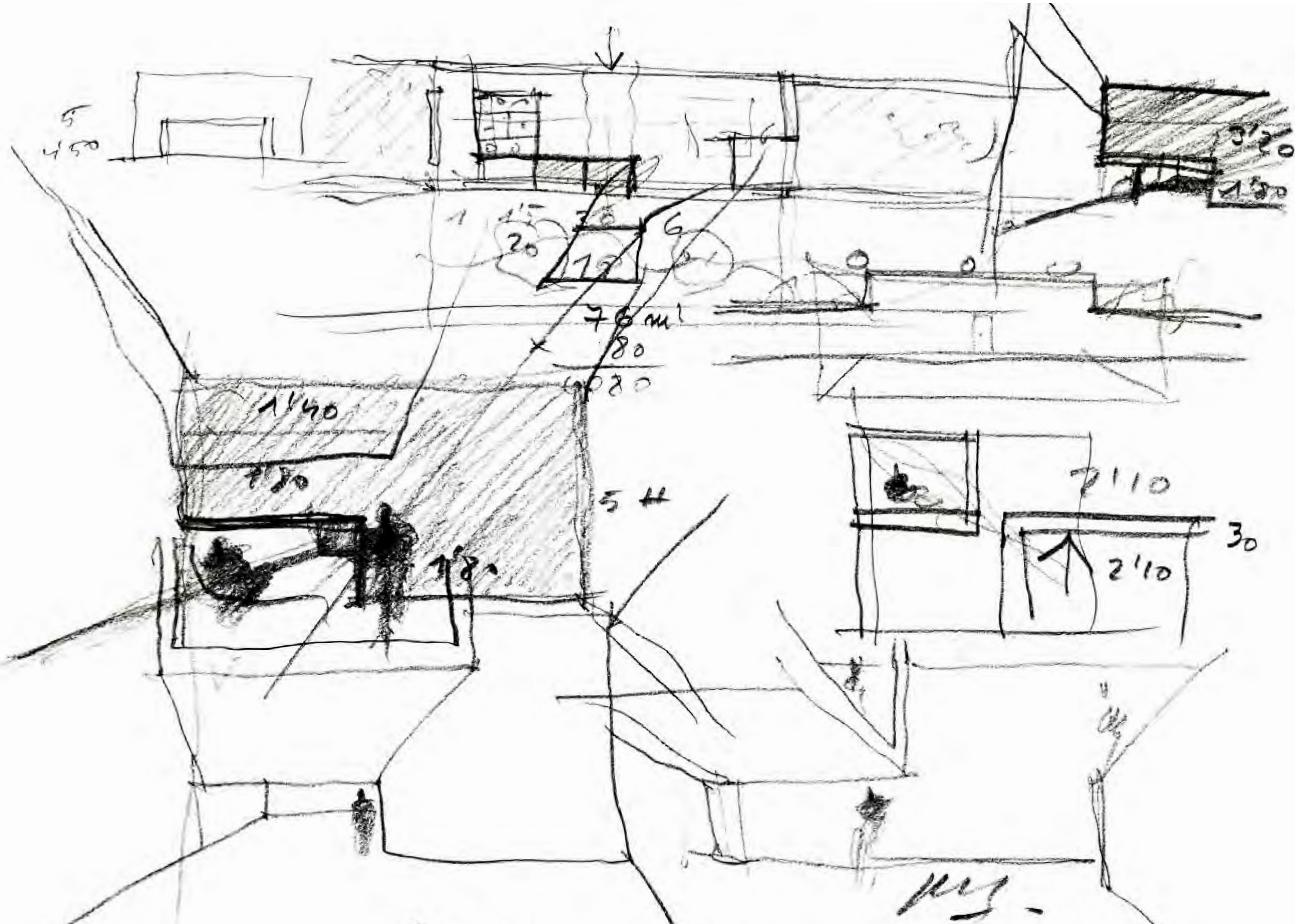

ms.

CB house / 30 décembre 1997
en el tren.

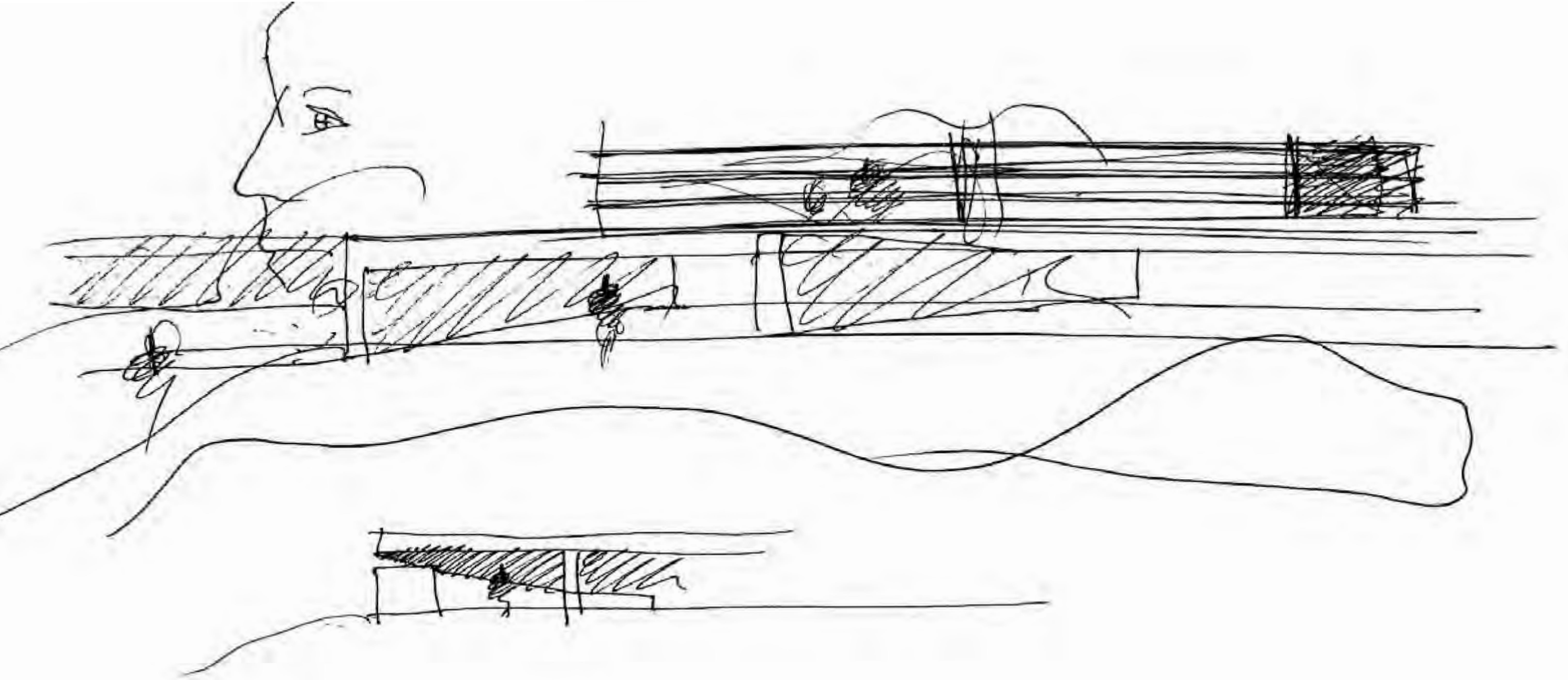

metro - subway - underground - tuf



pietra
maellera con CA